

DESCRIPTION

The MP44014-A is a boundary conduction mode PFC controller that provides simple and high-performance active power-factor correction using minimum external components.

The output voltage is regulated accurately by a high-performance voltage-mode amplifier with an accurate internal voltage reference.

The precise adjustable output over-voltage protection greatly enhances the system reliability.

The on-chip R/C filter on the current sense pin can potentially eliminate the external R/C filter.

The extremely low start-up current, quiescent current, and the disable function reduces the power consumption, resulting in excellent efficiency performance.

The MP44014-A is available in a SOIC-8.

FEATURES

- Boundary Conduction Mode PFC Controller for Pre-Regulator
- Zero-Crossing Compensation to Minimum THD of AC Input Current
- Precise Adjustable Output Over-Voltage Protection
- Ultra-Low (15µA) Start-Up Current
- Low Quiescent Current (0.46mA) at OVP Condition
- On-Chip Filter on Current Sense Pin
- Enable/Disable and Open-Loop Protection Function on FB
- -750/+800mA Peak Gate-Drive Current

APPLICATIONS

- Offline Adaptors
- Electronic Ballasts
- LLC Front End
- Other PFC Pre-Regulators

All MPS parts are lead-free, halogen-free, and adhere to the RoHS directive. For MPS green status, please visit the MPS website under Quality Assurance. "MPS" and "The Future of Analog IC Technology" are registered trademarks of Monolithic Power Systems, Inc.

TYPICAL APPLICATION

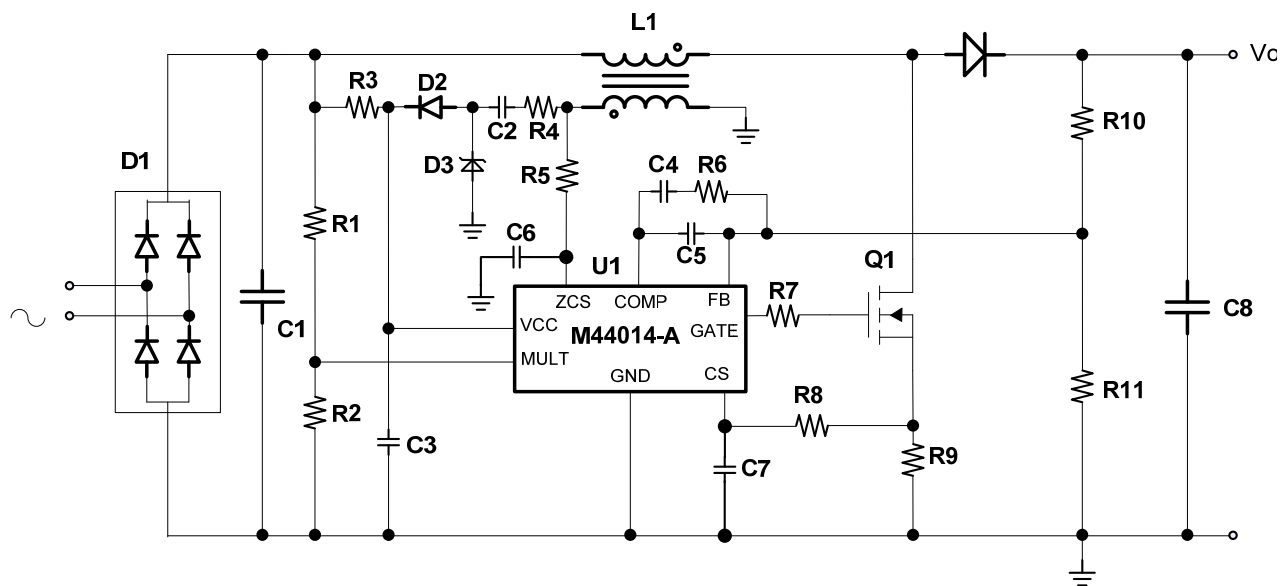

ORDERING INFORMATION

Part Number	Package	Top Marking
MP44014-AGS*	SOIC-8	See Below

* For Tape & Reel, add suffix -Z (e.g. MP44014-AGS-Z).

TOP MARKING

M44014-A

LLLLLLLL

MPSYWW

M44014-A: Product Code of MP44014-AGS
 LLLLLLLL: Lot Number
 MPS: MPS Prefix
 Y: Year Code
 WW: Week Code

PACKAGE REFERENCE

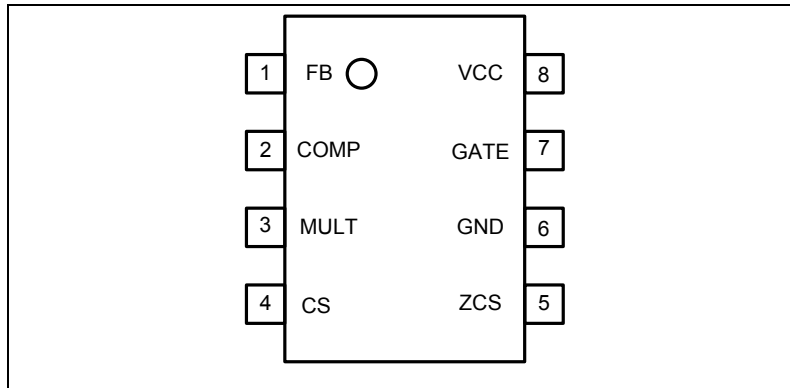

ABSOLUTE MAXIMUM RATINGS ⁽¹⁾

Supply Voltage VCC	-0.5V to Self Limit
Zero Current Sensing (ZCS) .	-0.3V to Self Limit
Other Analog Inputs and Outputs	-0.3V to 6.5V
ZCS Max. Current	-2.0mA to 10mA
Continuous Power Dissipation (T _A = +25°C) ⁽²⁾	
SOIC8	1.4W
Junction Temperature	150°C
Lead Temperature (Solder).....	260°C
Storage Temperature.....	-55°C to +150°C

Recommended Operating Conditions ⁽³⁾

Supply Voltage VCC	13.8V to 21V
Operating Junction Temp. (T _J).	-40°C to +125°C

Thermal Resistance ⁽⁴⁾	θ_{JA}	θ_{JC}
SOIC-8	90	45 ... °C/W

Notes:

- 1) Exceeding these ratings may damage the device.
- 2) The maximum allowable power dissipation is a function of the maximum junction temperature T_J(MAX), the junction-to-ambient thermal resistance θ_{JA}, and the ambient temperature T_A. The maximum allowable continuous power dissipation at any ambient temperature is calculated by $D(MAX)=(T_J(MAX)-T_A)/\theta_{JA}$. Exceeding the maximum allowable power dissipation produces an excessive die temperature, causing the regulator to go into thermal shutdown. Internal thermal shutdown circuitry protects the device from permanent damage.
- 3) The device is not guaranteed to function outside of its operating conditions.
- 4) Measured on JESD51-7, 4-layer PCB.

ELECTRICAL CHARACTERISTICS
VCC = 15V, T_J = -40°C~+125°C, unless otherwise noted

Parameter	Symbol	Condition	Min	Typ	Max	Units
Supply Voltage						
Operating Range	V _{CC}	After Turn-On	10.7		21	V
Turn-On Threshold	V _{CC_on}		11	12.4	13.8	V
Turn-Off Threshold	V _{CC_off}		8.7	9.8	10.8	V
Hysteresis	V _{CC_hys}		2.0		3.1	V
Zener Voltage	V _Z	I _{CC} =20mA	22	25	28	V
Supply Current						
Start-Up Current	I _{startup}	V _{CC} =11V		15	40	μA
Quiescent Current	I _q	No Switch		2.5	3.2	mA
Operating Current	I _{cc}	F _s =70kHz, C _{LOAD} =1nF		3.5	4.5	mA
Quiescent Current	I _q	During OVP (Either Static or Dynamic) or V _{FB} ≤150mV		0.46	0.7	mA
Multiplier						
Input Bias Current	I _{MULT}	V _{MULT} =3V			-1	μA
Linear Operation Range	V _{MULT}		0		3	V
Output Max. Slope	ΔV _{CS} /ΔV _{MULT}	V _{MULT} =0~0.6V V _{COMP} =Upper Clamp	1.0	1.10		V/V
Gain ⁽⁵⁾	K	V _{MULT} =1V, V _{COMP} =4V, T _J = 25°C	0.32	0.38	0.45	1/V
Error Amplifier						
Feedback Voltage	V _{FB}	T _J = 25°C	2.465	2.5	2.535	V
Feedback Voltage Line Regulation	V _{FB_LR}	V _{CC} =10.7V to 21V		2	5	mV
Feedback Bias Current	I _{FB}	V _{FB} =0~2.6V			1	μA
Source Current	I _{COMP_source}	V _{COMP} =4V, V _{FB} =2.4V, T _J = 25°C	-2.7	-4.7	-6.9	mA
Sink Current	I _{COMP_sink}	V _{COMP} =4V, V _{FB} =2.6V, T _J = 25°C	3	5		mA
Upper Clamp Voltage	V _{COMP_H}	V _{FB} =2V, I _{source} =-0.5mA	5.3	6	6.6	V
Lower Clamp Voltage	V _{COMP_L}	V _{FB} =3V, I _{sink} =0.5mA	2.0	2.15	2.3	V
FB_Disable Threshold	V _{FB_DIS}		150	200	250	mV
FB_EN Hysteresis	V _{FB_EN_hys}			250		mV
Current-Sense Comparator						
Input Bias Current	I _{CS}	V _{CS} =6.5V			-1	μA
Turn-Off Delay	T _{DT}	V _{MULT} =0.2V		175		ns
LEB Time	T _{LEB}	V _{MULT} =0.2V	40	80	130	ns
Current-Sense Clamp Voltage	V _{CS_Clamp}		1.06	1.14	1.22	V
Current-Sense Offset	V _{CS_Offset}	V _{MULT} =0V		25		mV
		V _{MULT} =2.5V		6		mV
Zero Current Sensor						
Upper Clamp Voltage	V _{ZCSclamp_H}	I _{ZCS} =2.5mA	7.2	7.8	8.7	V

ELECTRICAL CHARACTERISTICS (continued)
VCC = 15V, T_A = T_J = -40°C~+125°C, unless otherwise noted.

Parameter	Symbol	Condition	Min	Typ	Max	Units
Lower Clamp Voltage	V _{ZCSclamp_L}	I _{ZCS} =-2.5mA	-0.3	-0.15	0	V
Zero-Current Sensing Threshold	V _{ZCS_H}	V _{ZCS} Rising		1.4		V
	V _{ZCS_L}	V _{ZCS} Falling		0.7		V
Re-Start Current After Disable	I _{ZCS_res}		55	85		μA
Re-Starter						
Re-Start Time	T _{start}		80	175	280	μs
Over-Voltage						
Dynamic OVP Current	I _{OVP}		23.5	27	30.5	μA
Hysteresis	I _{OVP_Hys}			20		μA
Static OVP Threshold	V _{OVP}		2.1	2.25	2.4	V
Gate Driver						
Output High Voltage	V _{OH}	I _{GDsource} =20mA	11.5	12.5		V
Output Low Voltage	V _{OL}	I _{GDsink} =200mA		0.9	1.9	V
Voltage Fall Time	T _f			30	70	ns
Voltage Rise Time	T _r			40	80	ns
Max. Output Drive Voltage	V _{D_max}		12	13.5	15.5	V
Source Current Capability	I _{Gate_source}			-750		mA
Sink Current Capability	I _{Gate_sink}			800		mA
UVLO Saturation Voltage	V _{Saturation}	VCC=0 to VCC _{ON} , I _{Gate_sink} =10mA			0.3	V

Note:

 5) The multiplier output is given by: $V_{cs}=K \cdot V_{MUTL} \cdot (V_{COMP}-2.5)$

TYPICAL PERFORMANCE CHARACTERISTICS

Supply Current vs. Supply Voltage

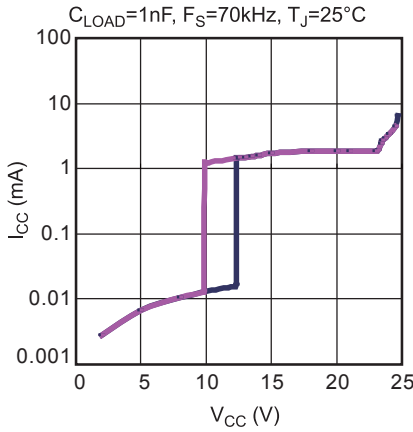

Supply Current vs. T_J

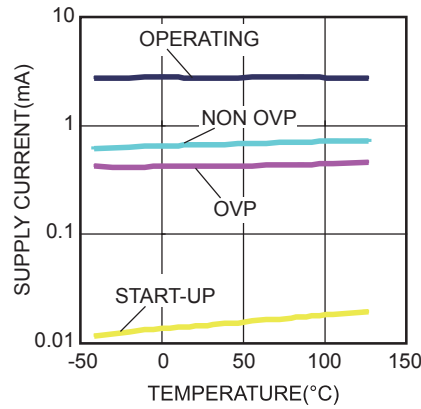

Start-Up & UVLO vs. T_J

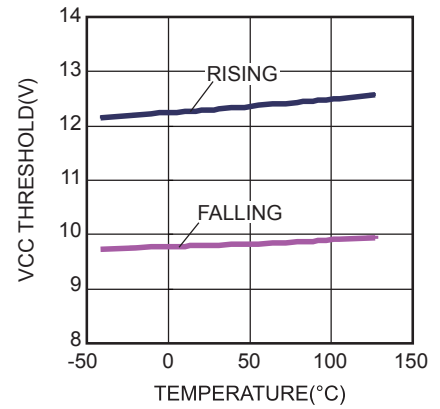

VCC Zener Voltage vs. T_J

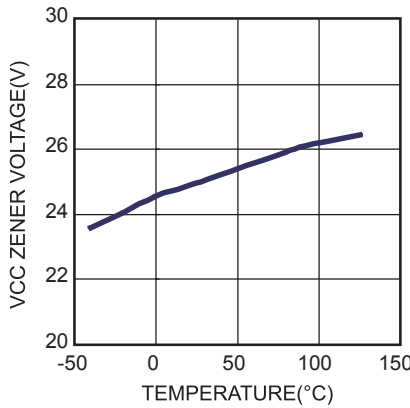

Feedback Reference vs. T_J

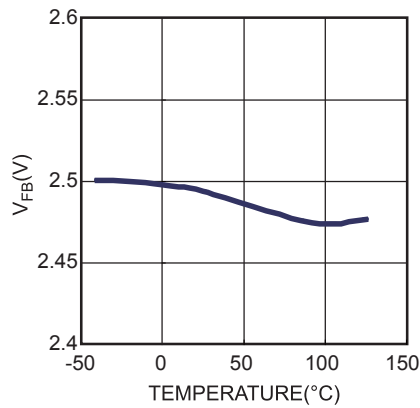

Delay-to-Output vs. T_J

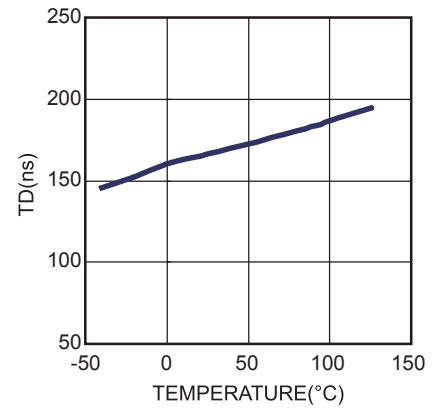

OVP Current vs. T_J

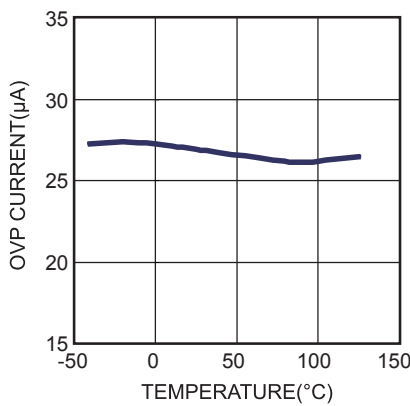

Multiplier Characteristic

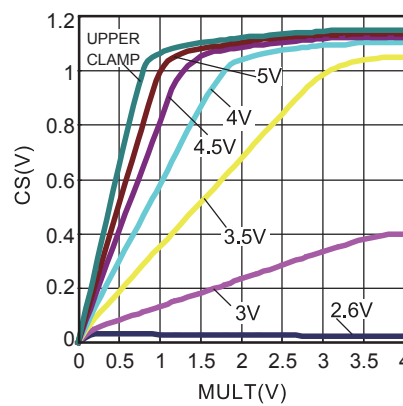

Multiplier Gain vs. T_J

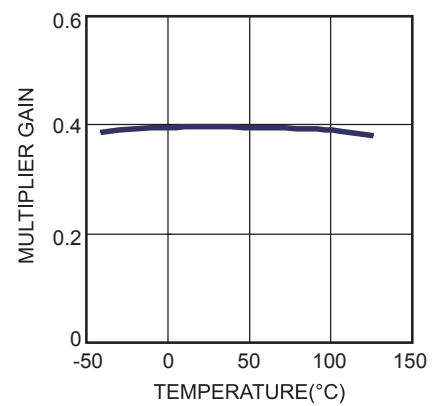

TYPICAL PERFORMANCE CHARACTERISTICS (continued)

ZCS Clamp Levels vs. T_J

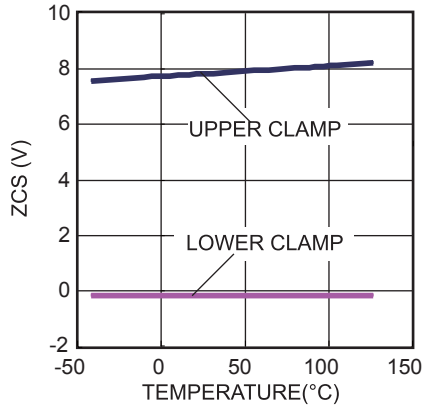

Gate-Drive Output High Saturation

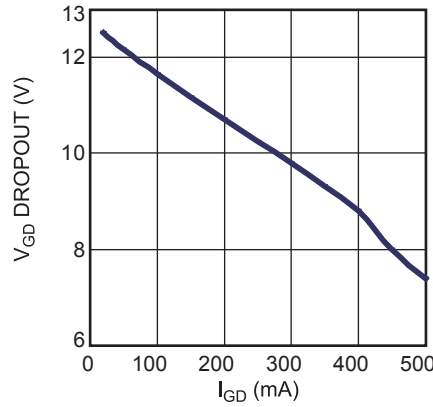

Gate-Drive Output Low Saturation

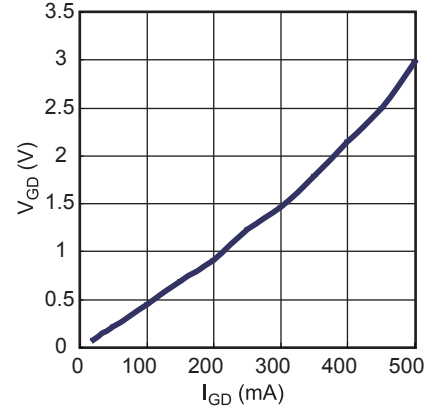

TYPICAL PERFORMANCE CHARACTERISTICS (continued)

Steady State
P_{OUT} = 100W

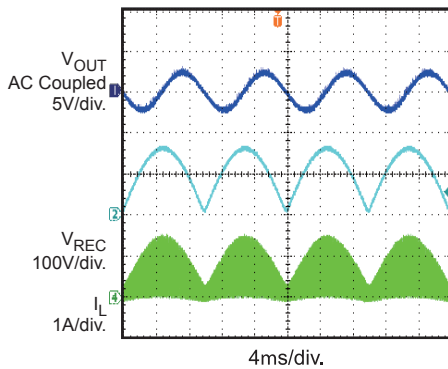

Steady State
P_{OUT} = 50W

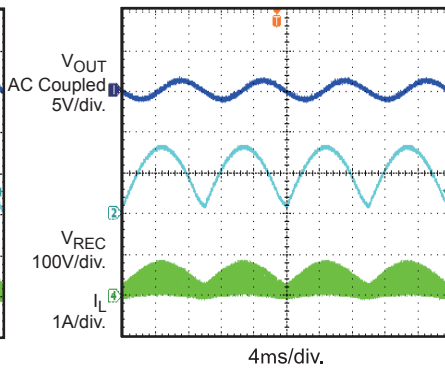

Steady State
P_{OUT} = 0W

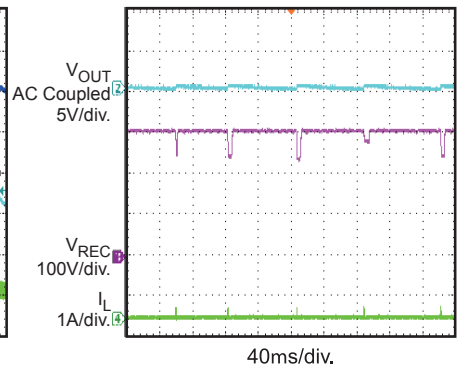

Start-Up

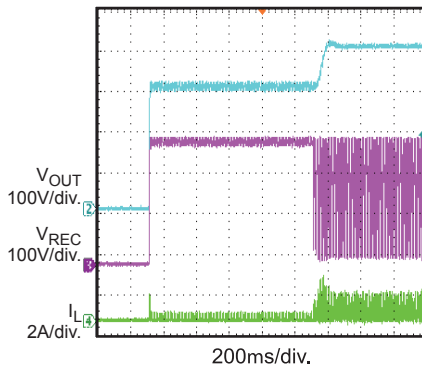

Shutdown

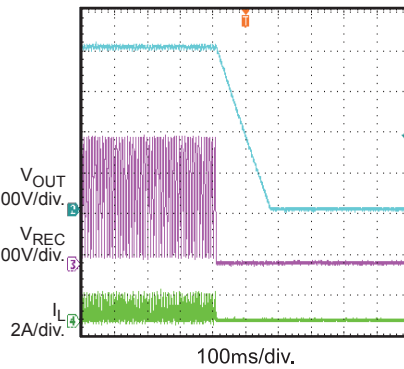

Zero-Current Sensing

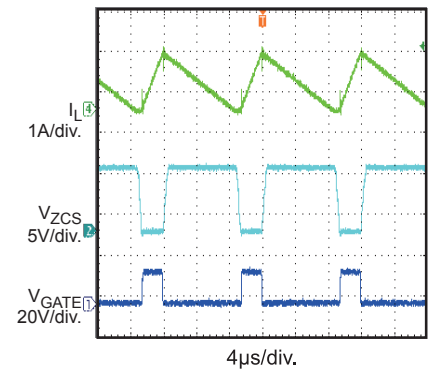

Zero-Crossing Compensation Harmonics
V_{AC} = 85V

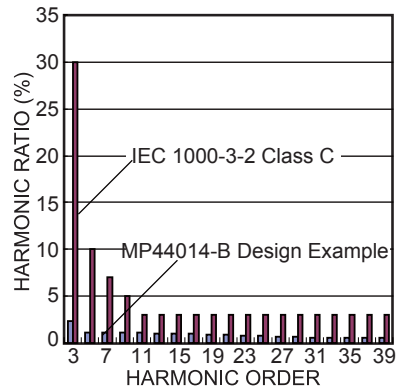
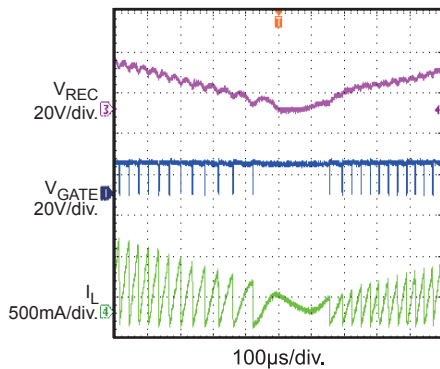

PIN FUNCTIONS

Pin #	Name	Description
1	FB	Feedback. The output voltage is fed into FB through a resistor divider. Also, FB can be used as an enable and disable pin.
2	COMP	Output of the Error Amplifier. A compensation network is connected between COMP and FB.
3	MULT	Input of the Multiplier. Connect MULT to the rectified main voltage via a resistor divider to provide the sinusoidal reference for the current control loop.
4	CS	Current Sense. The current through the MOSFET is fed into CS via a resistor. The resulting voltage on CS is compared with the output of the internal multiplier to get an internal sinusoidal-shaped reference, which determines the MOSFETs turn-on signal. The on-chip RC filter reduces high-frequency noise on CS.
5	ZCS	The Zero-Crossing Current-Sensing Input of the Inductor. A negative-transition edge triggers the MOSFETs turn-on signal.
6	GND	Ground.
7	GATE	Gate Driver Output. The high output current of the gate driver is able to drive the low-cost power MOSFET. The high-level voltage of GATE is clamped to 12V in case GATE is supplied with a high VCC.
8	VCC	Supply Voltage of Both the Signal Path of the IC and the Gate Driver. A bypass capacitor from VCC to ground is needed to reduce noise.

FUNCTIONAL BLOCK DIAGRAM

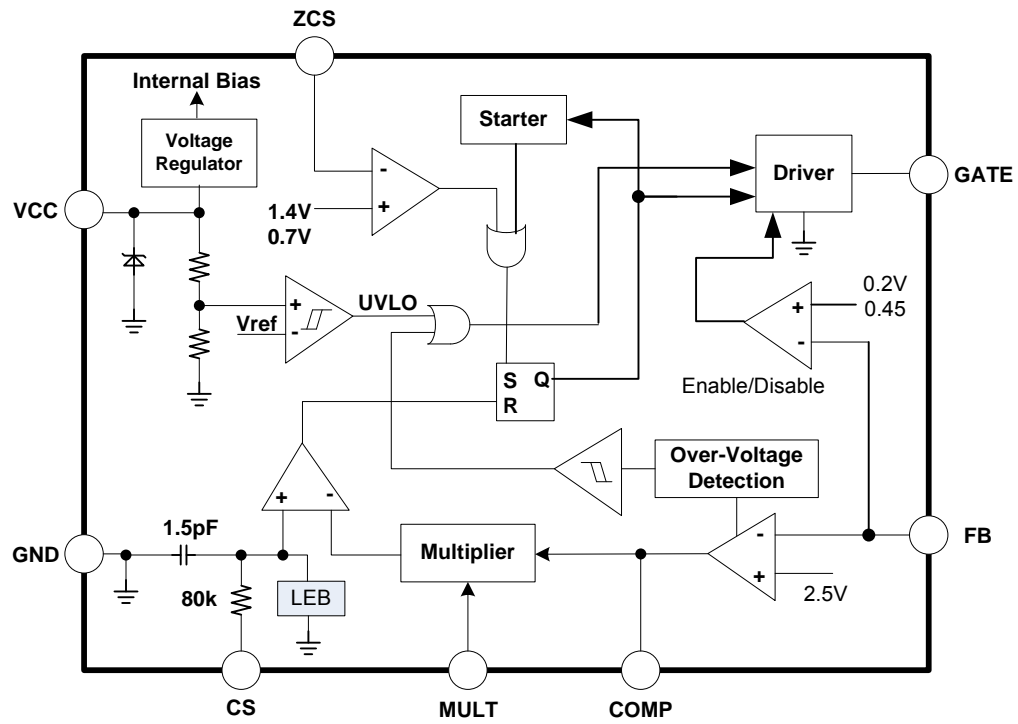

FIGURE 1. Functional Block Diagram

OPERATION

The MP44014-A is a boundary conduction mode PFC controller that is optimized for the PFC pre-regulator up to 300W and fully complies with the IEC1000-3-2 specification.

Output-Voltage Regulation

The output voltage is sensed at FB through a resistor divider from the output voltage to ground. The on-chip reference voltage and the high-performance error amplifier regulate the output voltage accurately.

Over-Voltage Protection (OVP)

The MP44014-A offers two stages of over-voltage protection: dynamic over-voltage protection and static over-voltage protection. With two-stage protection, the circuit operates reliably.

The MP44014-A achieves OVP by monitoring the current flow through COMP.

During steady-state operation, the current flow through the high-side feedback resistor (R9) and the low-side feedback resistor (R10) is:

$$I_{R9} = \frac{V_O - V_{FB}}{R9} = I_{R10} = \frac{V_{FB}}{R10}$$

If there is an abrupt rise on the output (ΔV_O), the compensation network connected between FB and COMP takes time to achieve a high-power factor (PF), due to the long RC time constant. The voltage on FB will still be kept at the reference value. The current through R10 remains equal to $V_{FB}/R10$, but the current through R9 will become:

$$I'_{R9} = \frac{V_O + \Delta V_O - V_{FB}}{R9}$$

This current has to flow into COMP. At the same time, this current is monitored inside the chip. If the current rises to 25µA, the output voltage of the multiplier will be forced to decrease, and the energy delivering to output will be reduced. If this current continues to rise (to about 27µA), the dynamic OVP could be triggered. Consequently, the gate driver is blocked to turn off the external power MOSFET, and the device enters an idle state. This state is maintained until the current falls below 10µA, the point at which the internal

starter will be re-enabled and allow the switching to re-start.

When the load is very light, the output voltage tends to stay steadily above the nominal value. In this condition, the error amplifier output will saturate low. When the error amplifier output is lower than 2.25V, the static OVP is triggered. Consequently, the gate driver is blocked to turn off the external power MOSFET, and the device enters an idle state. Normal operation resumes once the error amplifier output goes back into the regulated region (see Fig. 2).

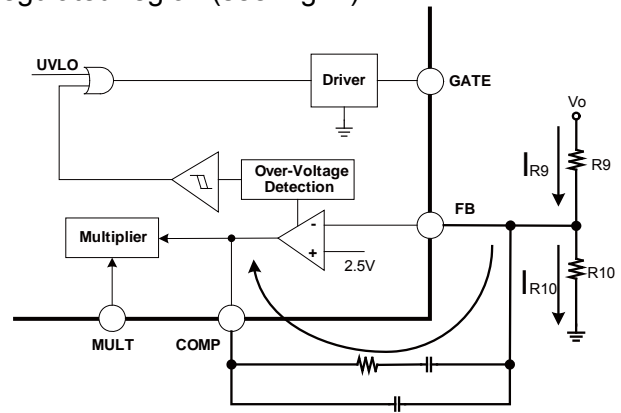

FIGURE 2. OVP Detector Block

Disable/Enable or OLP Function

The MP44014-A can be disabled by pulling FB lower than 200mV. This helps reduce quiescent current when the PFC pre-regulator needs to shut down. To enable the IC, the voltage on FB must exceed 0.45V. This function is used mainly as a remote on/off control input that is driven by a PWM controller for power management purposes. Also, FB acts as an open-loop protection for safety purposes. The IC shuts off PWM if the lower resistor of the output divider is shorted to ground or if the upper resistor is missing or fails to open.

Boundary Conduction Mode

When the current of the boost inductor reaches zero, the voltage on the inductor is reversed. Then ZCS generates the turn-on signal of the MOSFET by sensing the falling edge of the voltage on the auxiliary winding coupled with the inductor. If the voltage of ZCS rises above 1.4V, the comparator waits until the voltage falls

below 0.7V. Once the voltage falls below 0.7V, the MP44014-A turns on the MOSFET. The 7.8V high clamp protects ZCS. The internal 175µs timer generates a signal to turn on the MOSFET if the driver signal has been low for more than 175µs. This also allows the MOSFET to turn on during the start-up period since no signal is generated from ZCS.

Zero-Crossing Compensation

The MP44014-A offers a 30mV voltage offset for the multiplier output near the zero-crossing of the line voltage. This forces the circuit to process more energy at the bottom of the line voltage. With this function, the THD of the current is reduced.

To prevent redundant energy, this offset is reduced as the instantaneous line voltage increases. Therefore, the offset is negligible near the top of the line voltage.

Power Factor Correction

The MP44014-A senses the inductor current through CS and compares it to the sinusoidal-shaped signal (which is generated from the output of the multiplier). When the external power MOSFET turns on, the inductor current rises linearly. When the peak current hits

the sinusoidal-shaped signal, the external power MOSFET begins to turn off, and the diode turns on. Also, the inductor current begins to fall. When the inductor current reaches zero, the power MOSFET begins to turn on again, which causes the inductor current to start rising again. The power circuit works in boundary conduction mode, and the envelope of the inductor current is sinusoidal-shaped. The average input current is half of the peak current, so the average input current is sinusoidal-shaped as well (see Fig. 3). A high-power factor can be achieved through this control method.

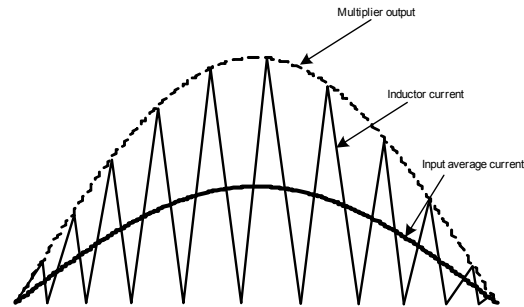

FIGURE 3. Inductor Current Waveform

The control flow chart of the MP44014-A is shown in Fig. 4.

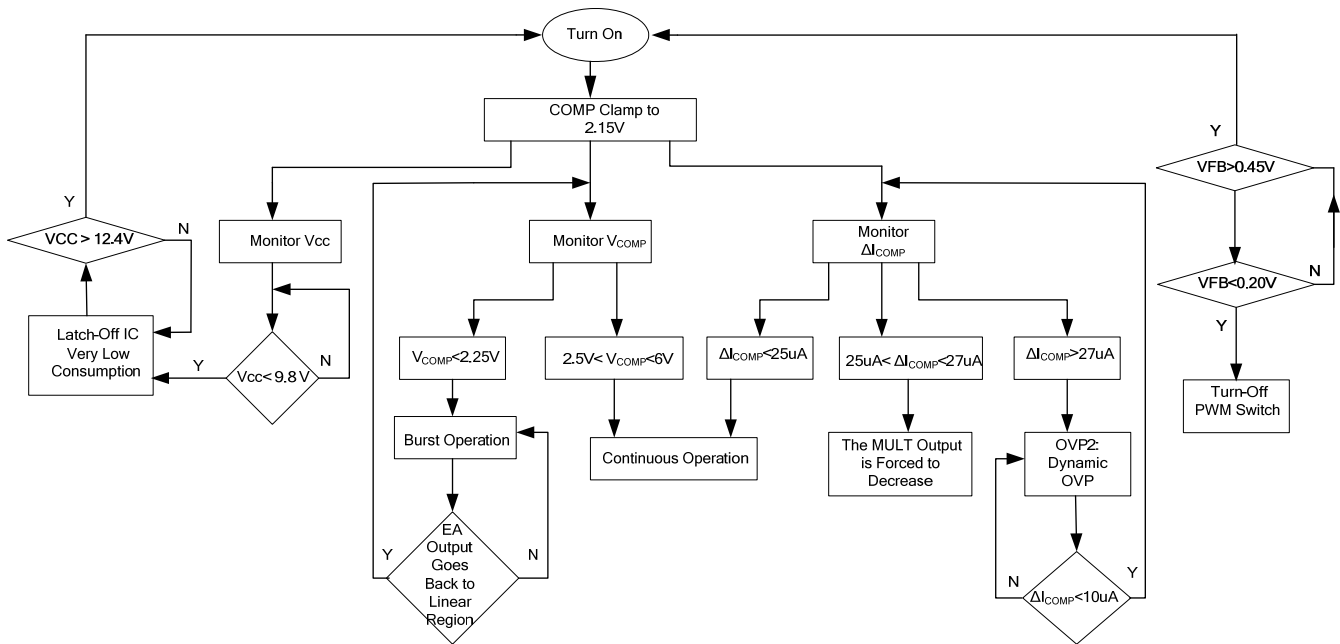
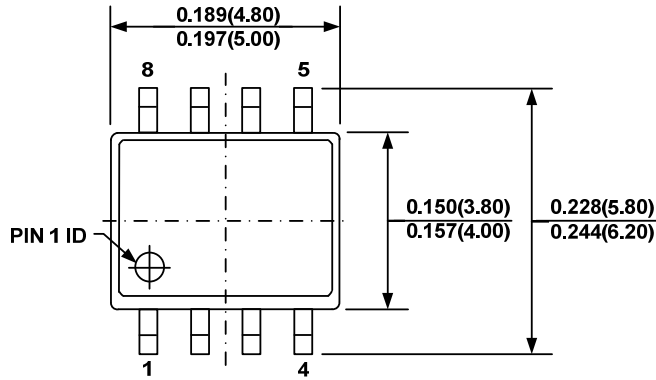

FIGURE 4. Control Flow Chart

PACKAGE INFORMATION

SOIC-8



TOP VIEW

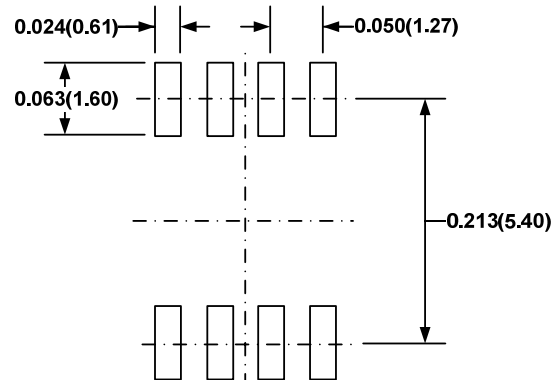

RECOMMENDED LAND PATTERN

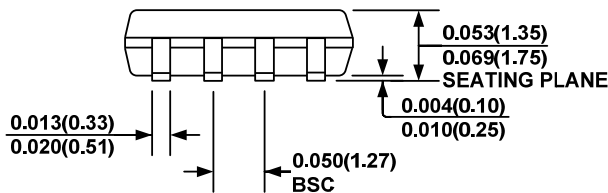

FRONT VIEW

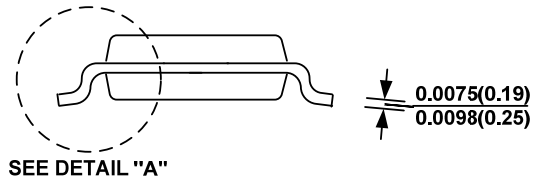

SIDE VIEW

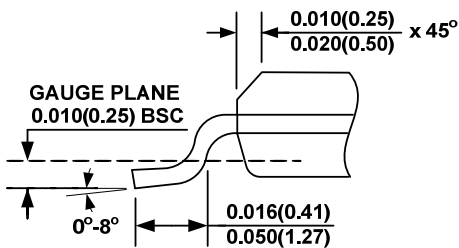

DETAIL "A"

NOTE:

- 1) CONTROL DIMENSION IS IN INCHES. DIMENSION IN BRACKET IS IN MILLIMETERS.
- 2) PACKAGE LENGTH DOES NOT INCLUDE MOLD FLASH, PROTRUSIONS OR GATE BURRS.
- 3) PACKAGE WIDTH DOES NOT INCLUDE INTERLEAD FLASH OR PROTRUSIONS.
- 4) LEAD COPLANARITY (BOTTOM OF LEADS AFTER FORMING) SHALL BE 0.004" INCHES MAX.
- 5) DRAWING CONFORMS TO JEDEC MS-012, VARIATION AA.
- 6) DRAWING IS NOT TO SCALE.

NOTICE: The information in this document is subject to change without notice. Users should warrant and guarantee that third party Intellectual Property rights are not infringed upon when integrating MPS products into any application. MPS will not assume any legal responsibility for any said applications.