



The Future of Analog IC Technology®

EV100L-N-00A Offline Inductor-Less Regulator EV Board

DESCRIPTION

The MP100L is a compact, inductor-less, good-efficiency, off-line regulator. It steps down the AC line voltage to an adjustable DC output. It is a simple solution to provide a bias voltage to ICs in off-line applications. Its integrated smart-control system uses AC line power only when necessary, thus minimizing device losses to achieve good efficiency. This device can help system designs meet new standby power specifications.

The MP100L provides various protections, such as Thermal Shutdown (TSD), VD Over Voltage Protection (OVP), VD Short to GND Protection, Over Load Protection (OLP), Short Circuit Protection (SCP).

The MP100L is available in SOIC8E package.

ELECTRICAL SPECIFICATION

Parameter	Symbol	Value	Units
Supply Voltage	V_{IN}	85~265	VAC
Output Voltage	V_{OUT}	12	V
Output Current	I_{OUT}	20	mA

FEATURES

- Universal AC Input (85VAC-to-305VAC)
- Inductor-Less
- Less than 100mW Standby Power
- Excellent EMI
- Low BOM Cost
- Smart Control to Maximum Efficiency
- Adjustable Output Voltage from 1.5V to 15V
- Good Line and Load Regulation
- Thermal Shutdown Protection
- Short-Circuit Protection
- Provide Power-Good Signal

APPLICATIONS

- Wall Switches and Dimmers
- Z-Wave Device and ZigBee Device for Home Automation
- Standby Power for General Off-line Applications

All MPS parts are lead-free and adhere to the RoHS directive. For MPS green status, please visit MPS website under Quality Assurance. "MPS" and "The Future of Analog IC Technology" are Registered Trademarks of Monolithic Power Systems, Inc.

EV100L-N-00A EVALUATION BOARD



(L x W x H) 21mm x 14mm x 20mm

Board Number	MPS IC Number
EV100L-N-00A	MP100GN

EVALUATION BOARD SCHEMATIC

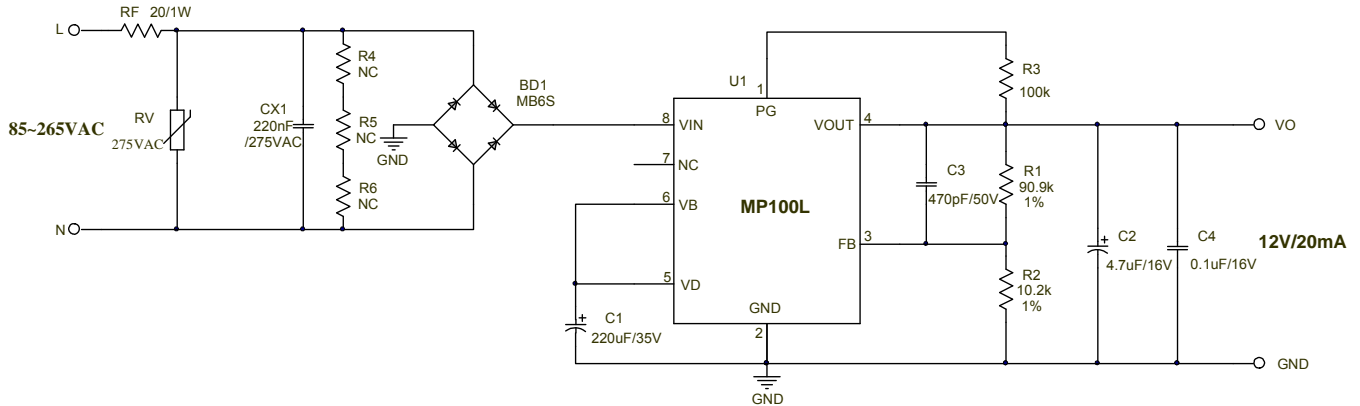

VOUT can be adjusted by choosing the value of R1 and R2, the relationship of them is:

$$V_{OUT} = 1.235V * (1 + R1/R2)$$

For example, to get 5V output voltage, we can choose, R4=10.2k, R5=30.9k.

The maximum output power of MP100L Vs input voltage is depicted by following chart for 12V, 5V and 3.3V output applications respectively.

The test condition is: in open frame, full bridge rectifier, ambient temperature is 25 °C, the temperature rise of MP100L is less than 60 °C on the test board.

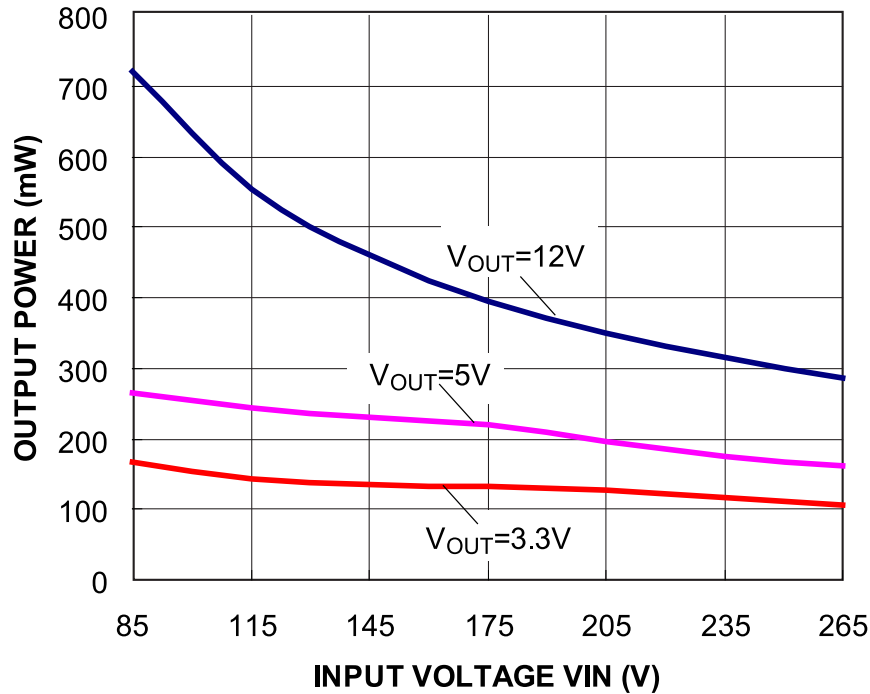

EV100L-N-00A BILL OF MATERIAL

Qty	Ref	Value	Description	Package	Manufacture	Manufacturer_PN
1	BD1	MB6S	Diode;600V;0.5A;	SOIC-4	TaiWan Semiconductor	MB6S
1	C1	220uF	Electrolytic Capacitor;35V;	DIP	Jianghai	CD110-35V220
1	C2	4.7uF	Electrolytic Capacitor;16V;	DIP	Nichicon	UMA1C4R7MCD2
1	C3	470pF	Ceramic Capacitor;50V;C0G;	0603	Murata	GRM1885C1H471JA01D
1	C4	100nF	Ceramic Capacitor;16V;X7R;	0603	Murata	GRM188R71C104KA01D
1	CX1	220nF	Film Capacitor;275V;10%	DIP	Kaili	PX24K3IC59L270D9R
1	R1	90.9kΩ	Film Resistor;1%;	0603	Yageo	RC0603FR-0790K9L
1	R2	10.2kΩ	Film Resistor;1%;	0603	Yageo	RC0603FR-0710K2L
1	R3	100kΩ	Film Resistor;1%;	0603	Yageo	RC0603FR-07100KL
1	RF	20Ω	Fuse Resistor;5%;1W	DIP	Great Electronics	1WSJT-52-20R
1	RV	275Vac	TVR10431KSY, 430V(1 mA);	DIP	TKS	TVR10431KSY
1	U1	MP100L	Offline Regulator	SOIC8E	MPS	MP100LGN R1

EVB TEST RESULTS

Performance waveforms are tested on the evaluation board.

$V_{OUT} = 12V$, $I_{OUT} = 20mA$, $T_A = 25^\circ C$, unless otherwise noted.

Efficiency vs. Load

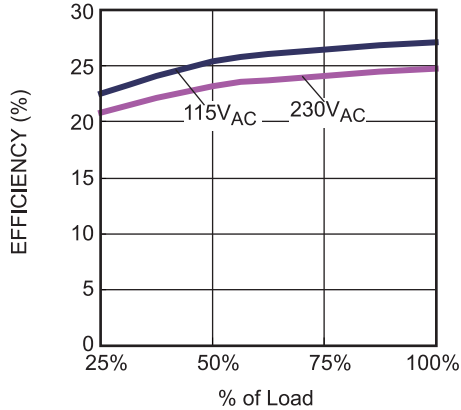

No Load Power vs. Input Voltage

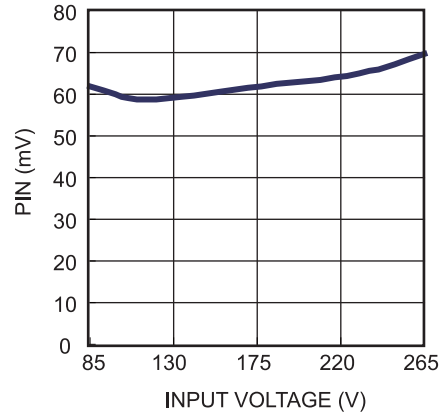

Input Power Start Up

$V_{IN} = 115V_{AC}$

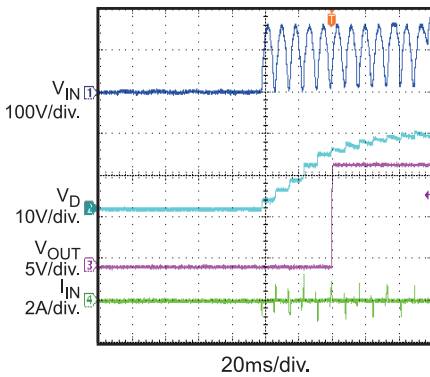

Input Power Start Up

$V_{IN} = 230V_{AC}$

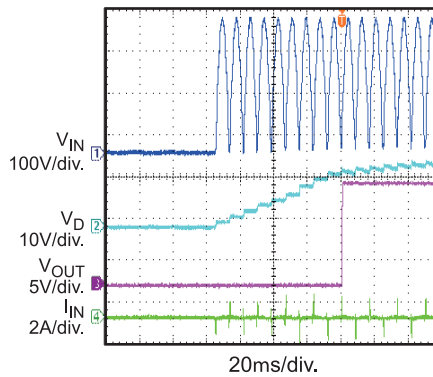

Steady State

$V_{IN} = 115V_{AC}$

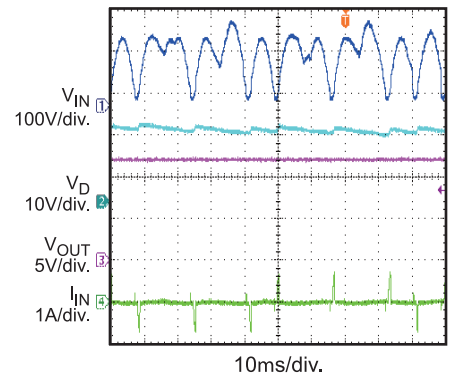

Steady State

$V_{IN} = 230V_{AC}$

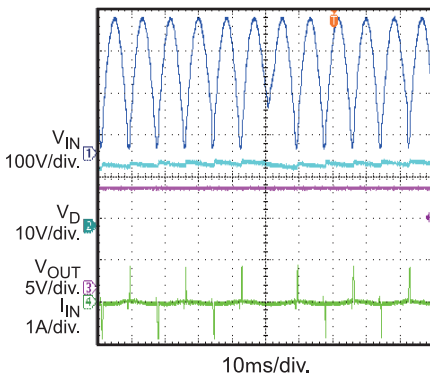

Input Power Shut Down

$V_{IN} = 115V_{AC}$

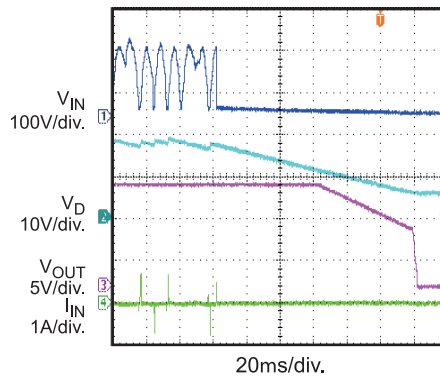

Input Power Shut Down

$V_{IN} = 230V_{AC}$

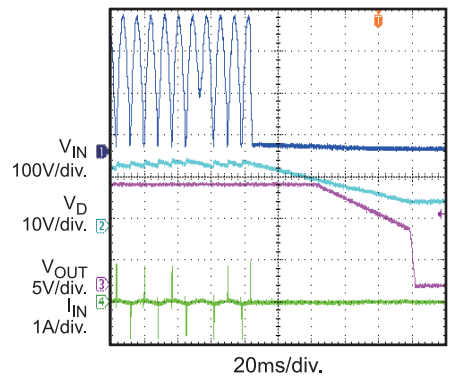

EVB TEST RESULTS *(continued)*

Performance waveforms are tested on the evaluation board.

$V_{OUT} = 12V$, $I_{OUT} = 20mA$, $T_A = 25^{\circ}C$, unless otherwise noted.

Output Ripple

$V_{IN} = 115V_{AC}$

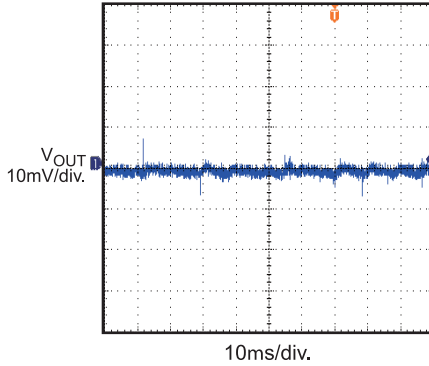

Output Ripple

$V_{IN} = 230V_{AC}$

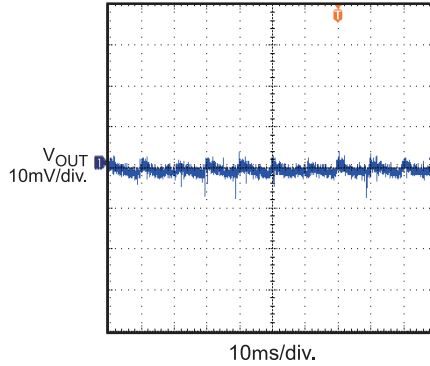

Load Transient

$V_{IN} = 115V_{AC}$, 0 to 20mA

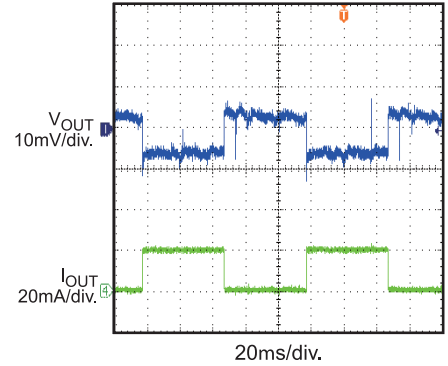

Load Transient

$V_{IN} = 230V_{AC}$, 0 to 20mA

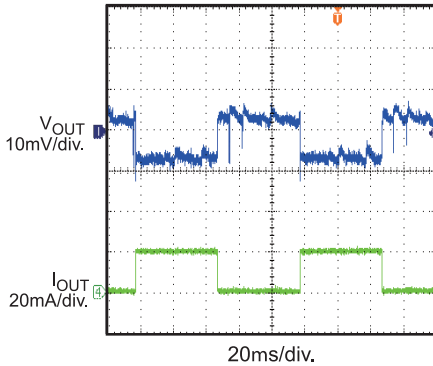

Over Load Protection Entry

$V_{IN} = 115V_{AC}$

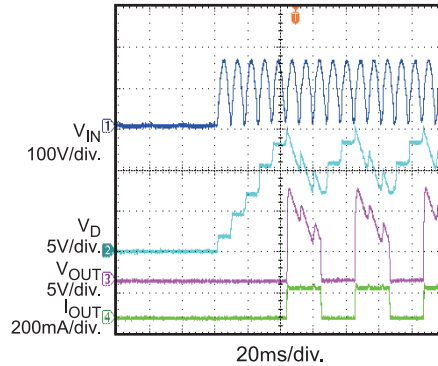

Over Load Protection Entry

$V_{IN} = 230V_{AC}$

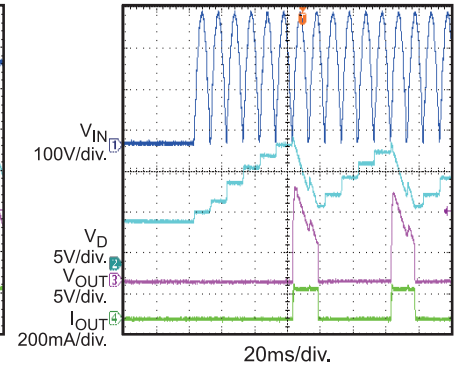

Over Load Protection Recovery

$V_{IN} = 115V_{AC}$

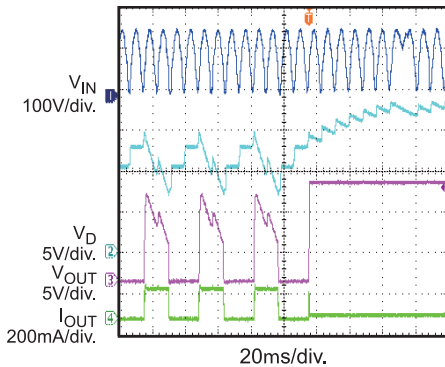

Over Load Protection Recovery

$V_{IN} = 230V_{AC}$

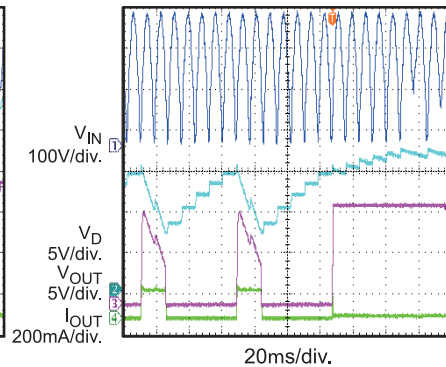

Short Circuit Protection Entry

$V_{IN} = 115V_{AC}$

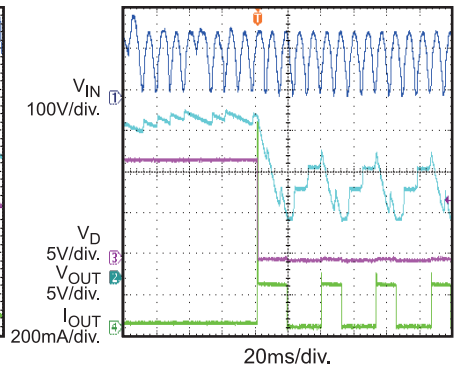

EVB TEST RESULTS *(continued)*

Performance waveforms are tested on the evaluation board.

$V_{OUT} = 12V$, $I_{OUT} = 20mA$, $T_A = 25^{\circ}C$, unless otherwise noted.

**Short Circuit
Protection Entry**

$V_{IN} = 230V_{AC}$

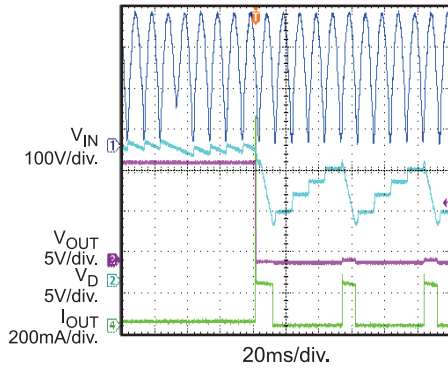

**Short Circuit
Protection Entry**

$V_{IN} = 115V_{AC}$

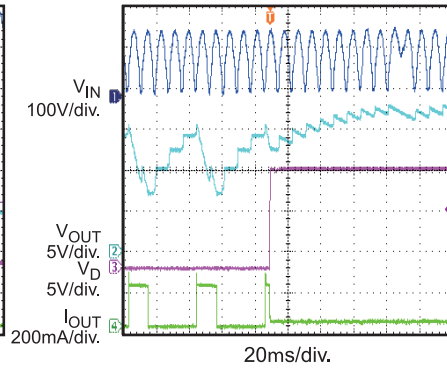

**Short Circuit
Protection Recovery**

$V_{IN} = 230V_{AC}$

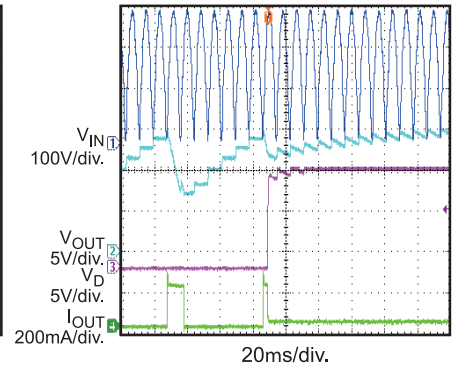

**VB Short to GND
Protection Entry**

$V_{IN} = 115V_{AC}$

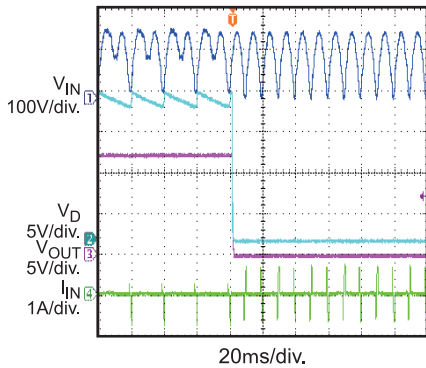

**VB Short to GND
Protection Entry**

$V_{IN} = 230V_{AC}$

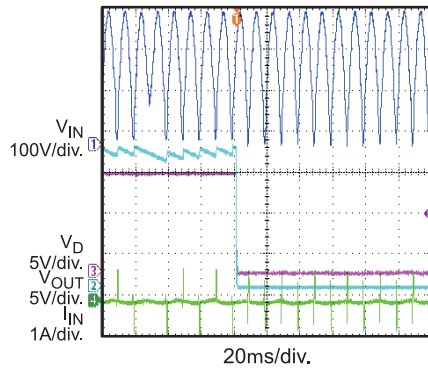

**VB Short to GND
Protection Recovery**

$V_{IN} = 115V_{AC}$

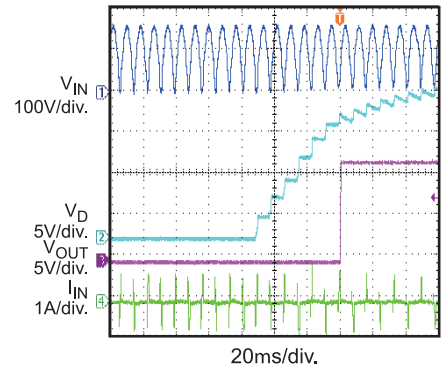

**VB Short to GND
Protection Recovery**

$V_{IN} = 230V_{AC}$

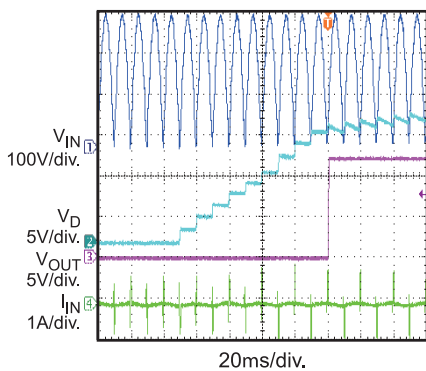

**Thermal Shutdown
Protection Entry**

$V_{IN} = 115V_{AC}$

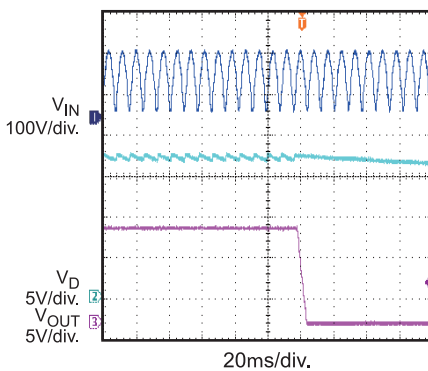

**Thermal Shutdown
Protection Entry**

$V_{IN} = 230V_{AC}$

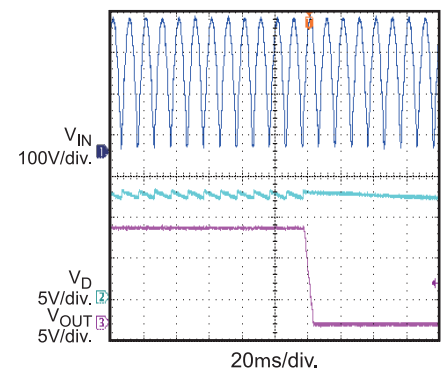

EVB TEST RESULTS *(continued)*

Performance waveforms are tested on the evaluation board.
 $V_{OUT} = 12V$, $I_{OUT} = 20mA$, $T_A = 25^\circ C$, unless otherwise noted.

Thermal Shutdown Protection Recovery
 $V_{IN} = 115V_{AC}$

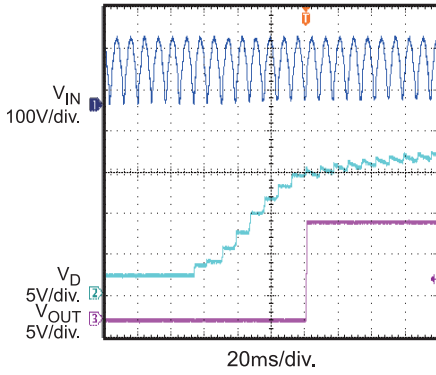

Thermal Shutdown Protection Recovery
 $V_{IN} = 230V_{AC}$

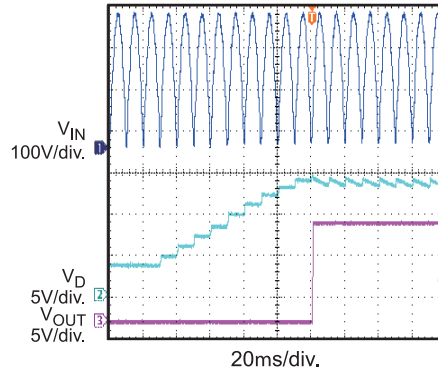

EMI Performance
 115 L Line

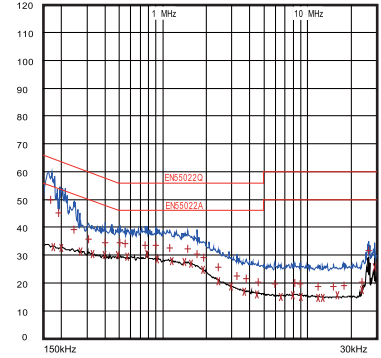

EMI Performance
 115 N Line

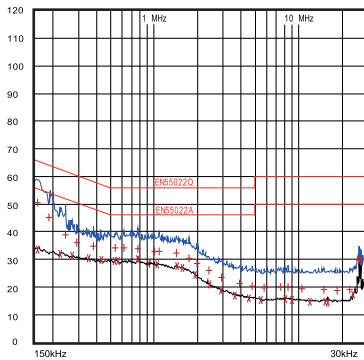

EMI Performance
 230 L Line

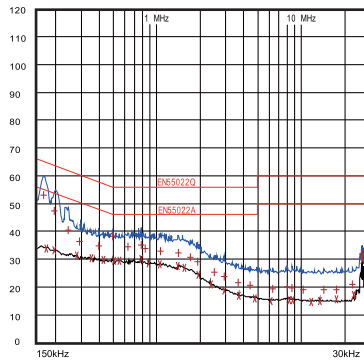

EMI Performance
 230 N Line

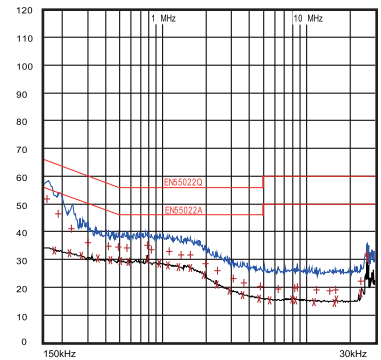

PRINTED CIRCUIT BOARD LAYOUT

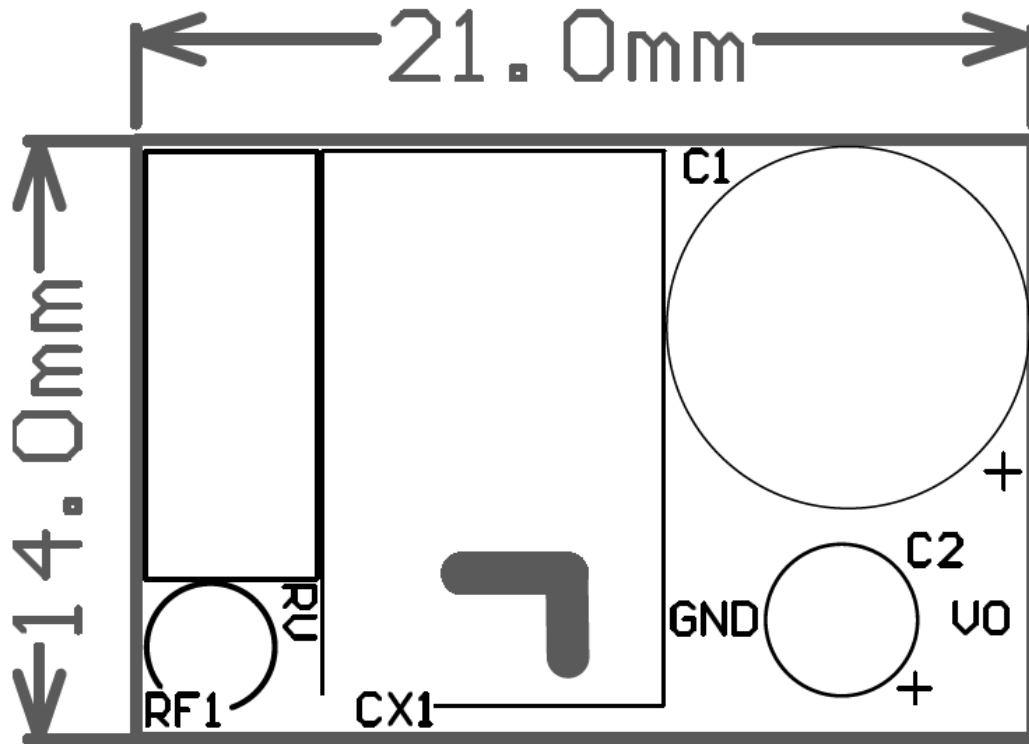

Figure 1 — Top Silk Layer

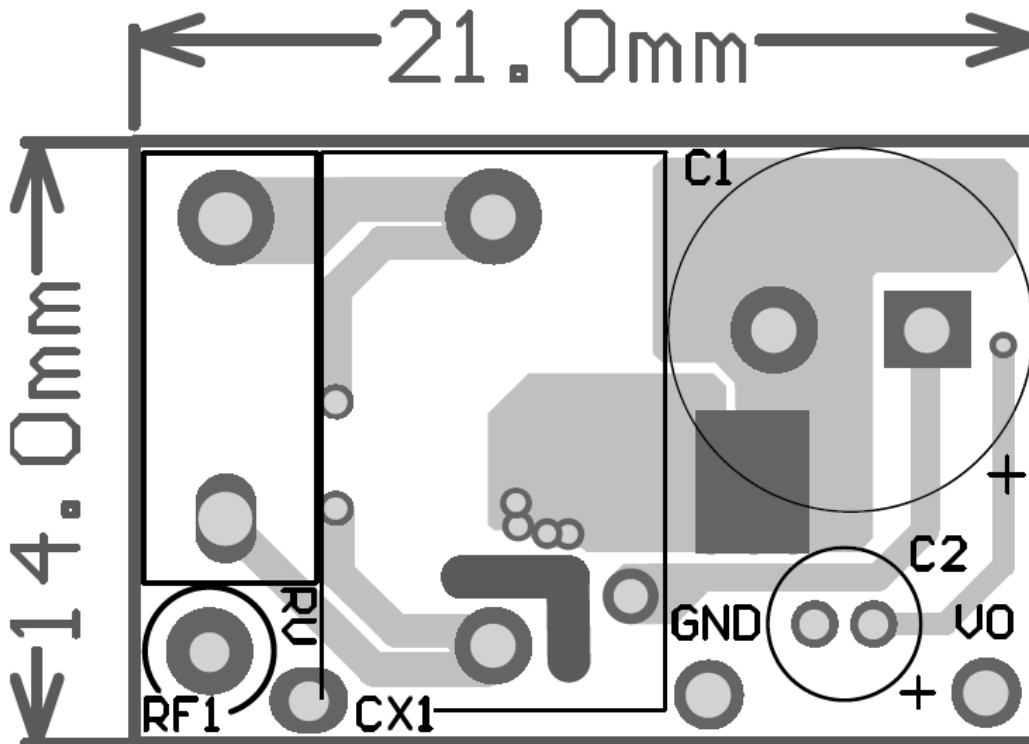

Figure 2 — Top Layer

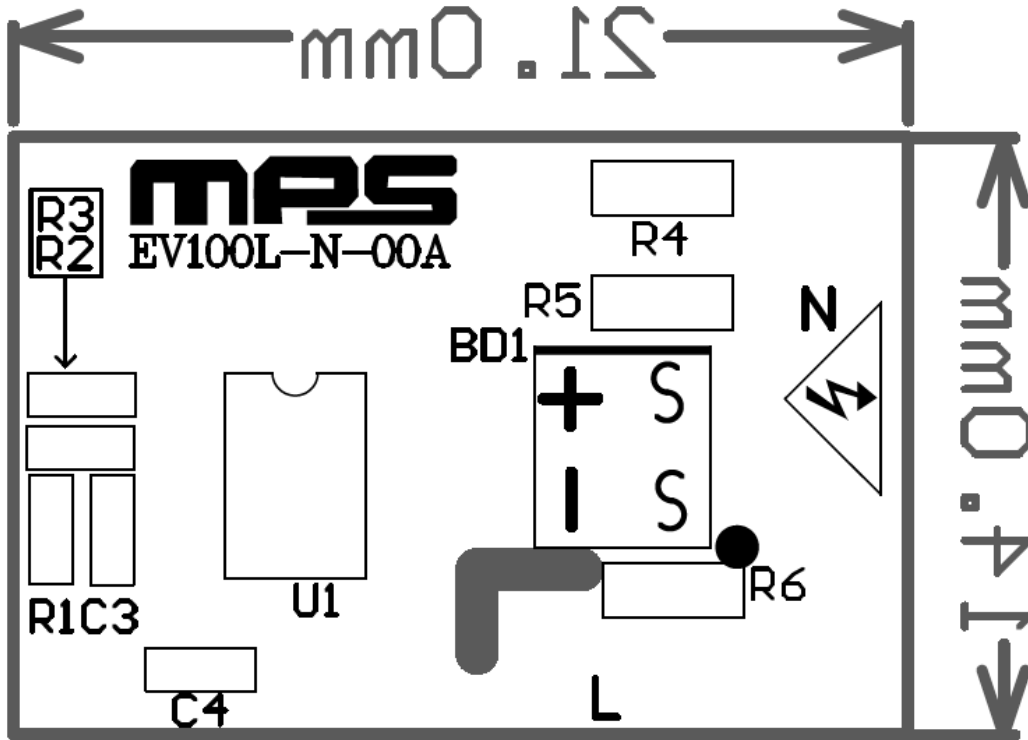

Figure 3 — Bottom Silk

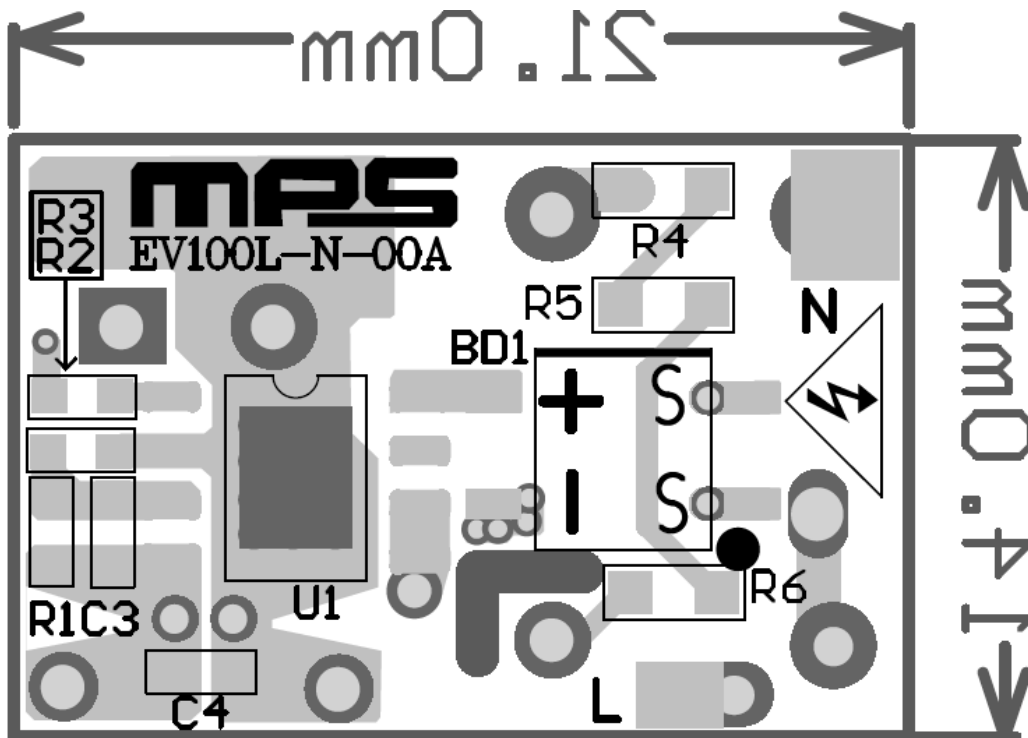

Figure 4 — Bottom Layer

QUICK START GUIDE

1. Preset Power Supply to $85V \leq V_{IN} \leq 265V$.
2. Turn Power Supply off.
3. Connect the Line and Neutral terminals of the power supply output to L and N ports.
4. Connect Load to VO and GND ports.
5. Turn Power Supply on after making connections.

NOTICE: The information in this document is subject to change without notice. Please contact MPS for current specifications. Users should warrant and guarantee that third party Intellectual Property rights are not infringed upon when integrating MPS products into any application. MPS will not assume any legal responsibility for any said applications.