

DESCRIPTION

The EV1476-TF-00A Evaluation Board is designed to demonstrate the capabilities of MPS' MP1476, a fully-integrated high-frequency, synchronous rectified, step-down, switch-mode converter with internal power MOSFETs. It offers a very compact solution to achieve a 2A continuous output current over a wide input range, with excellent load and line regulation. The MP1476 has synchronous-mode operation for higher efficiency over the output current-load range.

Constant On-Time control operation provides very fast transient response and easy loop design as well as very tight output regulation.

Full protection features include SCP, OCP, UVP and thermal shutdown.

The MP1476 requires a minimal number of readily-available, standard, external components and is available in a space-saving SOT563 package.

ELECTRICAL SPECIFICATION (1)

Parameter	Symbol	Value	Units
Input Voltage	V_{IN}	12	V
Output Voltage	V_{OUT}	3.3	V
Output Current	I_{OUT}	2	A

Notes:

1) For different Input/output voltage specs and different output capacitor/inductor may need change the application circuit parameters.

FEATURES

- Wide 4.2V-to-18V Operating Input Range
- 130mΩ/54mΩ Low- $R_{DS(ON)}$ Internal Power MOSFETs
- 180μA Low I_q
- High-Efficiency Synchronous-Mode Operation
- Power Save Mode at Light Load
- Fast Load Transient Response
- 800kHz Switching Frequency
- Internal Soft-Start
- Over-Current Protection and Hiccup
- Thermal Shutdown
- Output Adjustable from 0.8V
- Available in a SOT563 package

APPLICATIONS

- Security Camera
- Digital Set-Top Boxes
- Flat-Panel Television and Monitors
- General Purposes

All MPS parts are lead-free, halogen free, and adhere to the RoHS directive. For MPS green status, please visit MPS website under Quality Assurance.

"MPS" and "The Future of Analog IC Technology" are Registered Trademarks of Monolithic Power Systems, Inc.

EV1476-TF-00A EVALUATION BOARD



(L x W x H) 63.7mm x 48.4mm x 5.6mm

Board Number	MPS IC Number
EV1476-TF-00A	MP1476GTF

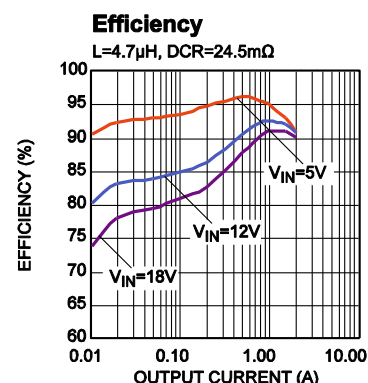

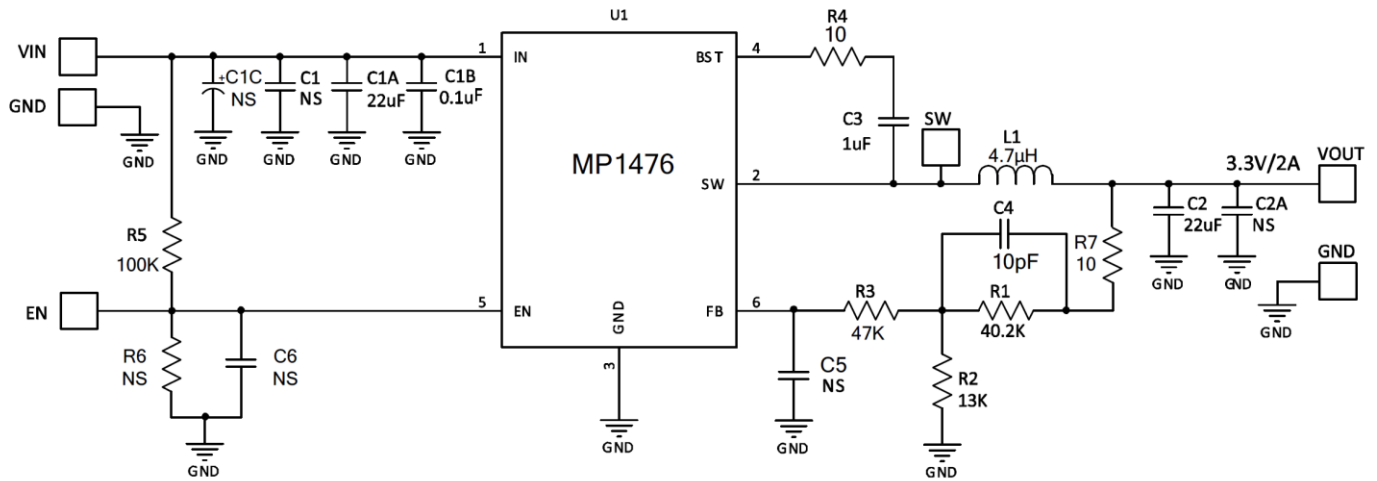
EVALUATION BOARD SCHEMATIC

EV1476-TF-00A BILL OF MATERIALS

Qty	Ref	Value	Description	Package	Manufacturer	Part Number
1	C1A	22 μ F	Ceramic Cap., 25V, X5R	0805	muRata	GRM21BR61E226ME44L
1	C1B	0.1 μ F	Ceramic Cap., 25V, X7R	0603	muRata	GRM188R71E104KA01D
1	C2	22 μ F	Ceramic Cap., 16V, X5R	0805	muRata	GRM21BR61C226ME44L
1	C3	1 μ F	Ceramic Cap., 16V, X7R	0603	muRata	GRM188R71C105KA12D
0	C1,C1C, C2A,C5,C6	NS				
1	C4	10pF	Ceramic Cap., 50V, C0G	0603	muRata	GRM1885C1H100JA01D
1	R1	40.2k	Thick Film Res., 1%	0603	Yageo	RC0603FR-0740K2L
1	R2	13k	Thick Film Res., 1%	0603	Yageo	RC0603FR-0713KL
1	R3	47k	Thick Film Res., 1%	0603	Yageo	RC0603FR-0747KL
1	R4,R7	10 Ω	Thick Film Res., 1%	0603	Yageo	RC0603JR-0710RL
1	R5	100k	Thick Film Res., 1%	0603	Yageo	RC0603FR-07100KL
0	R6	NS				
1	L1	4.7 μ H	Inductor, DCR=24.5m Ω ,Is=4.7A	SMD	Wurth	744316470
1	U1	MP1476GTF	Synchronous Step-Down Convert	SOT563	MPS	MP1476GTF

EVB TEST RESULTS

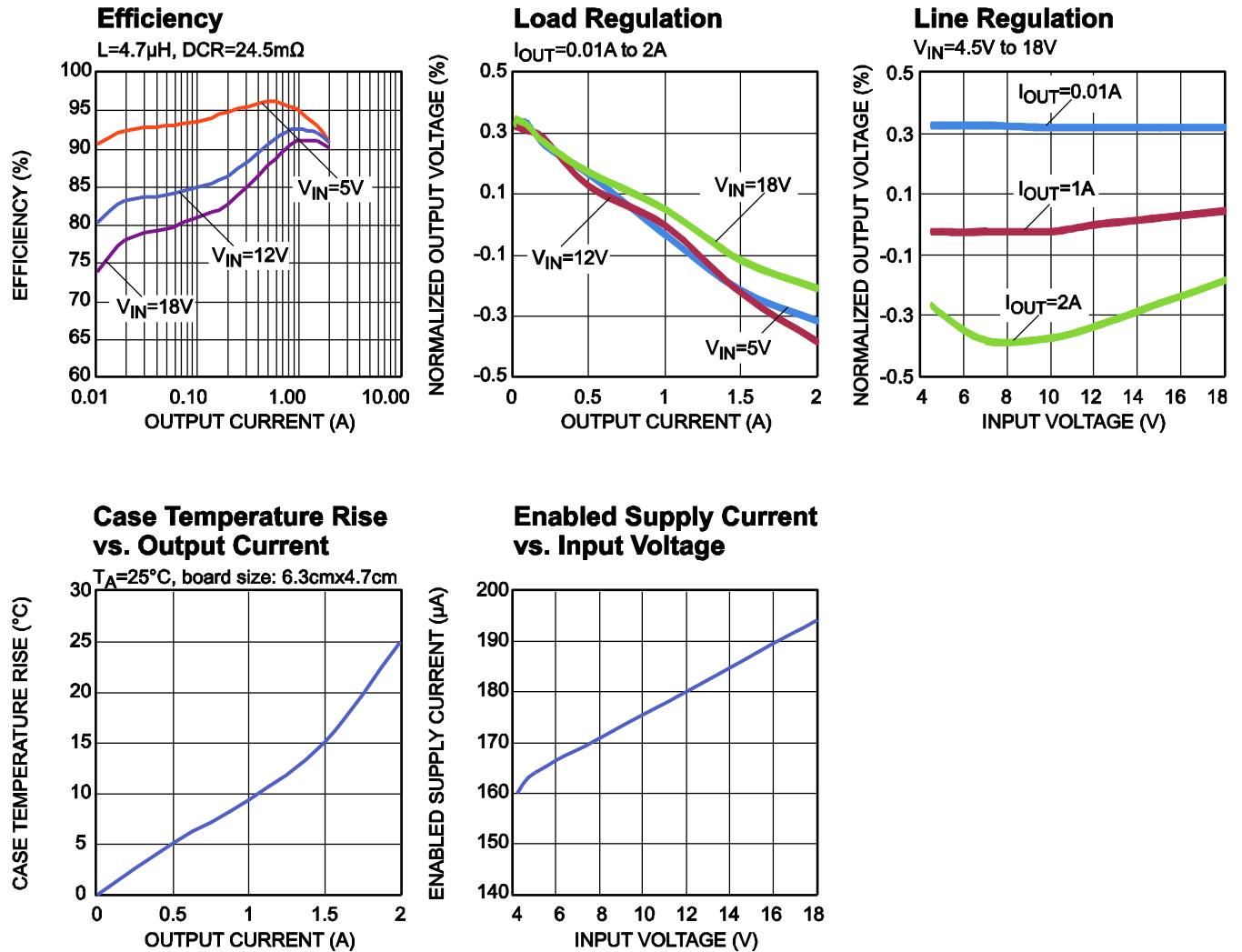
$V_{IN} = 12V$, $V_{OUT} = 3.3V$, $L = 4.7\mu H$, $T_A = +25^\circ C$, unless otherwise noted.

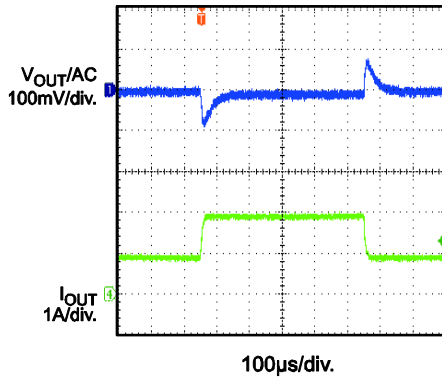
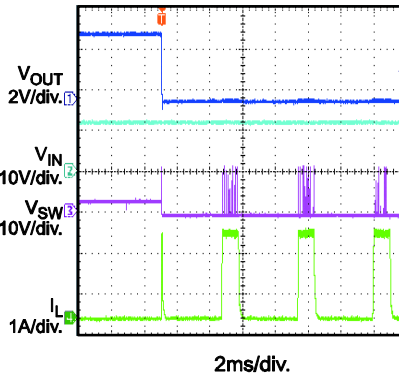
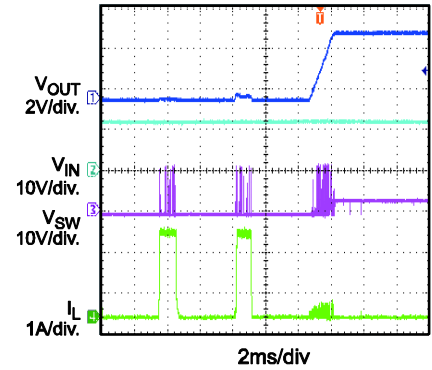
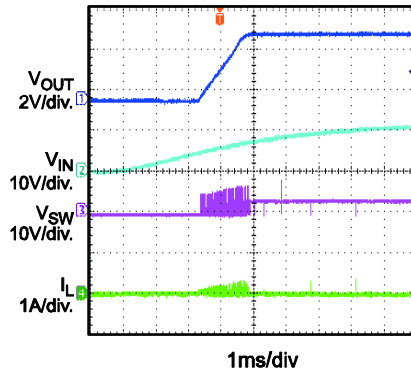
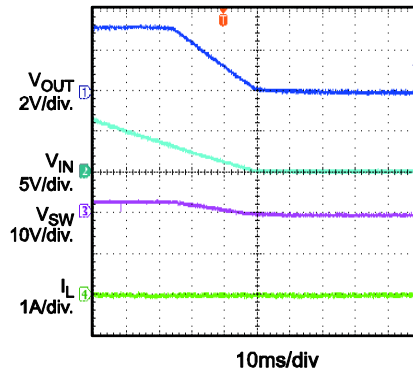
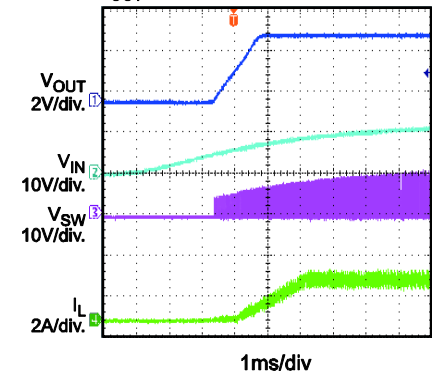
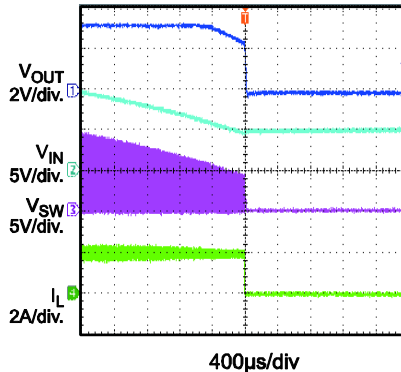
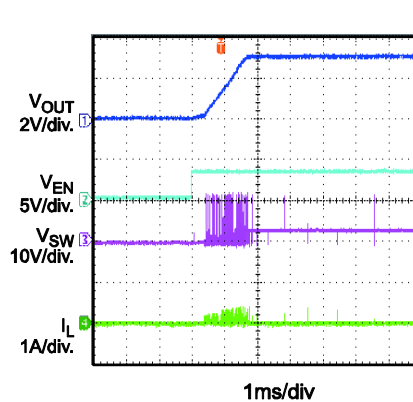
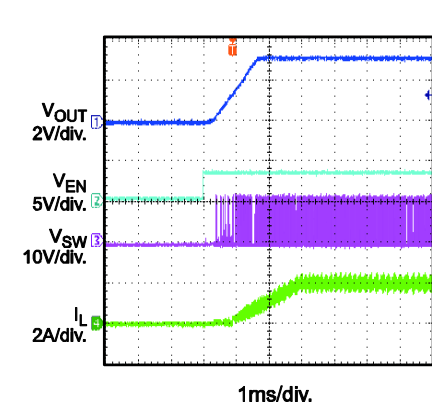

EVB TEST RESULTS (continued)
 $V_{IN} = 12V$, $V_{OUT} = 3.3V$, $L = 4.7\mu H$, $T_A = +25^\circ C$, unless otherwise noted.

Transient Response
 $I_{OUT} = 1A$ to $2A$, $2.5A/\mu s$

Short Circuit Entry
 $I_{OUT} = 0A$

Short Circuit Recovery
 $I_{OUT} = 0A$

Startup through Input Voltage
 $I_{OUT} = 0A$

Shutdown through Input Voltage
 $I_{OUT} = 0A$

Startup through Input Voltage
 $I_{OUT} = 2A$

Shutdown through Input Voltage
 $I_{OUT} = 2A$

Startup through Enable
 $I_{OUT} = 0A$

Startup through Enable
 $I_{OUT} = 2A$

PRINTED CIRCUIT BOARD LAYOUT

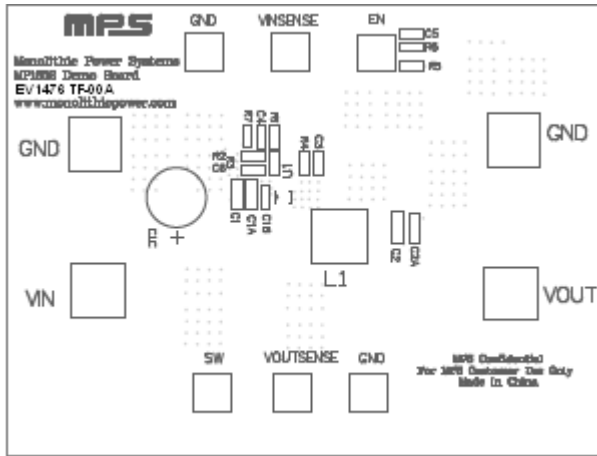

Figure 1: Top Silk Layer

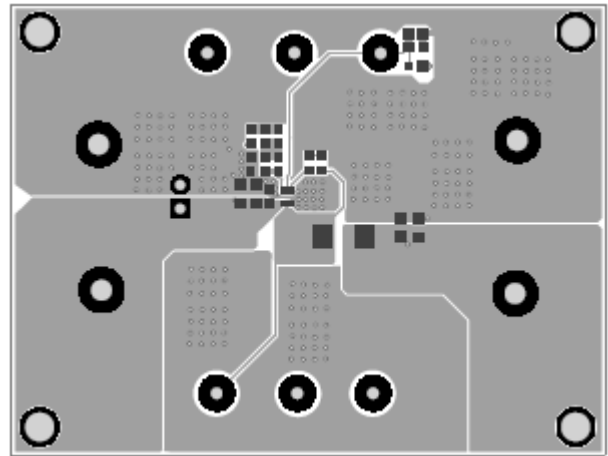

Figure 2: Top Layer

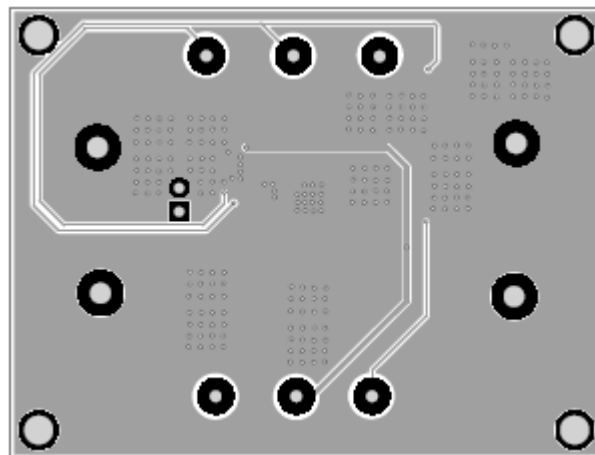

Figure 3: Bottom Layer

QUICK START GUIDE

1. Preset Power Supply to 12V.
2. Turn Power Supply off.
3. Connect Power Supply terminals to:
 - a. Positive (+): VIN
 - b. Negative (-): GND
4. Connect Load to:
 - a. Positive (+): VOUT
 - b. Negative (-): GND
5. Turn Power Supply on after making connections. The board will automatically start up.
6. To use the Enable function, apply a digital input to the EN pin. Drive EN higher than 1.3V to turn on the regulator, or less than 1V to turn it off.

NOTICE: The information in this document is subject to change without notice. Please contact MPS for current specifications. Users should warrant and guarantee that third party Intellectual Property rights are not infringed upon when integrating MPS products into any application. MPS will not assume any legal responsibility for any said applications.