

### DESCRIPTION

The EV1924-R-00A is an evaluation board for the MP1924, a high frequency Half-Bridge gate driver. Its high-side and low-side driver channels are independently controlled and matched with a time delay of less than 5ns.

The demo board is configured as a buck converter. INH and INL are independent signals of each other. Complementary PWMs with proper dead time should be implemented for INH and INL.

### ELECTRICAL SPECIFICATION

Parameter	Symbol	Value	Units
Driver Power Supply Voltage	V <sub>DD</sub>	9 - 16	V
Input Power Supply Voltage	V <sub>IN</sub>	0-100	V

### FEATURES

- 118V Bootstrap Voltage Range
- On-Chip Bootstrap Diode
- Quiescent Current of Less than 150uA
- Typical Propagation Delay of 20ns
- Gate Driver Matching of Less than 5ns
- UVLO for Both High-Side and Low-Side Gate Drivers
- TTL Compatible Input
- Available in a QFN-10 (4mmx4mm) and SOIC-8 Package

### APPLICATIONS

- Motor Drivers
- Telecom Half-Bridge Power Supplies
- Avionics DC/DC converters

All MPS parts are lead-free, halogen-free, and adhere to the RoHS directive. For MPS green status, please visit the MPS website under Quality Assurance. "MPS" and "The Future of Analog IC Technology" are registered trademarks of Monolithic Power Systems, Inc.

## EV1924-R-00A EVALUATION BOARD

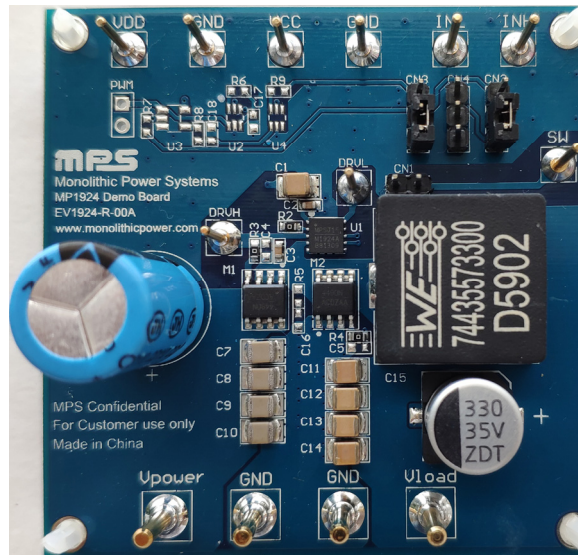

(L × W × H) 6.35cm x 6.35cm x 1cm

Board Number	MPS IC Number
EV1924-R-00A	MP1924HR

**EVALUATION BOARD SCHEMATIC**

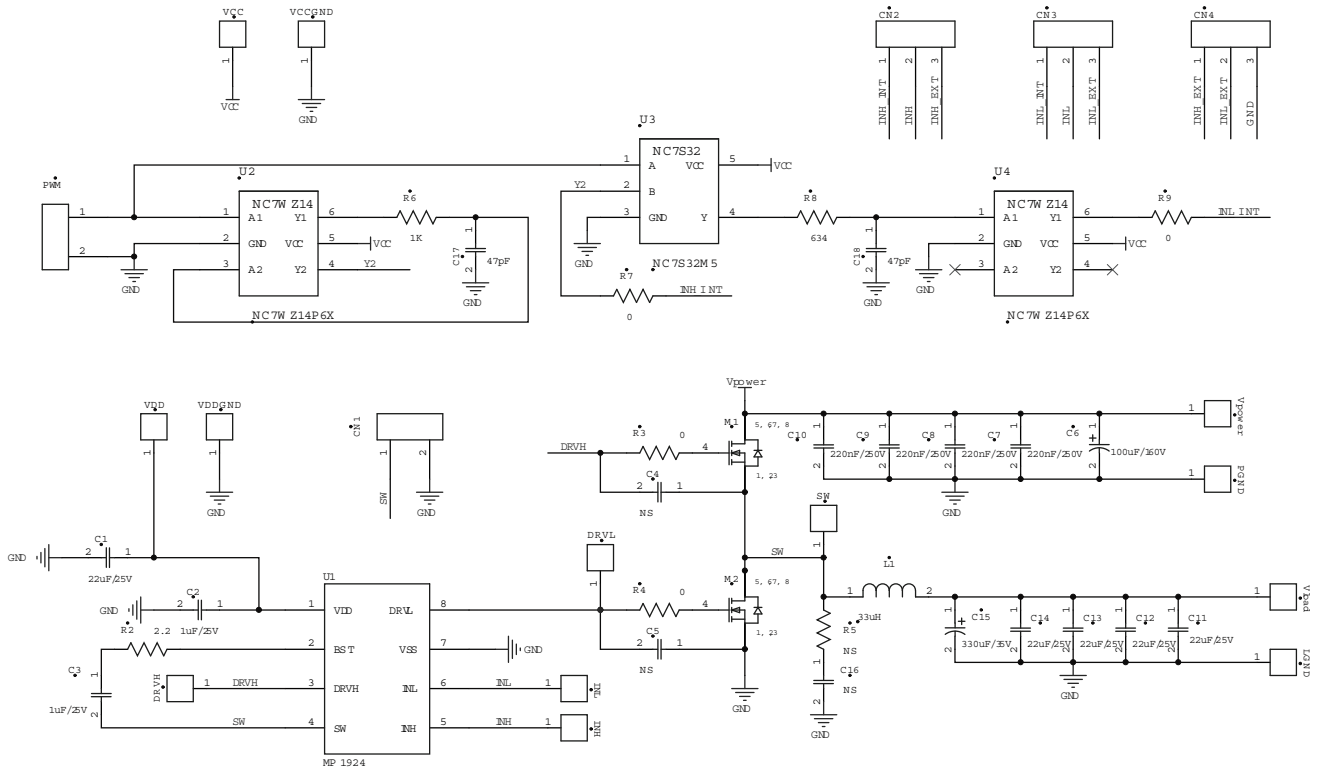

**EV1924-R-00A BILL OF MATERIALS**

Qty	RefDes	Value	Description	Package	Manufacturer	Manufacturer P/N
5	C1, C11, C12, C13, C14	22 $\mu$ F/ 25V	Ceramic Cap., 25V, X5R	1210	Murata	GRM32ER71E226KE15L
2	C2, C3	1 $\mu$ F/ 25V	Ceramic Cap., 25V, X5R	0603	TDK	C1608X5R1E105K
3	C4, C5, C16	NS				
1	C6	100 $\mu$ F/ 160V	Electrolytic Cap., 160V	DIP	江海	CD110-160V100
4	C7, C8, C9, C10	220nF/ 250V	Ceramic Cap., 250V, X7R	1210	Murata	GRM32DR72E224KW01L
1	C15	330 $\mu$ F/ 35V	Electrolytic Cap., 35V	SMD	江海	VZ1-35V330
1	L1	33 $\mu$ H	Inductor, 33 $\mu$ H, 8.5A;	SMD	Würth	74435573300
1	R5	NS				
3	R2, R3, R4	0	Film Resistor, 5%,	0603	Yageo	RC0603JR-070RL
2	M1, M2	AM4490N	N-channel MOS	PowerPAK SO-8	Analog Power	AM4490N
1	U1	MP1924	Integrated Gate Driver	QNF4x4	MPS	MP1924HR
4	Vpower, Vload, GNDx2		2mm 金针			
9	VDD, GND, VCC, GND, INL, INH, DRVH, DRVL, SW		1mm 金针			

**PRINTED CIRCUIT BOARD LAYOUT**

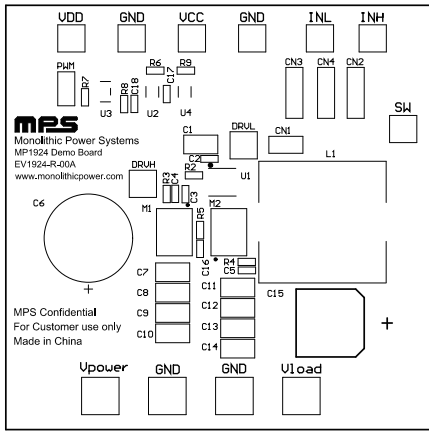

**Figure 1: Top Silkscreen Layer**

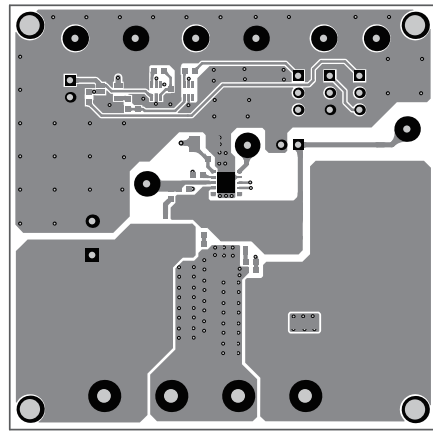

**Figure 2: Top Layer**

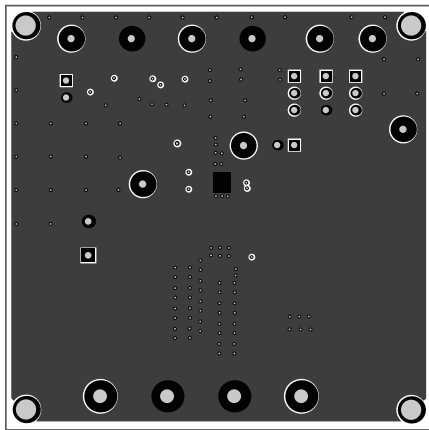

**Figure 3: Mid-Layer1**

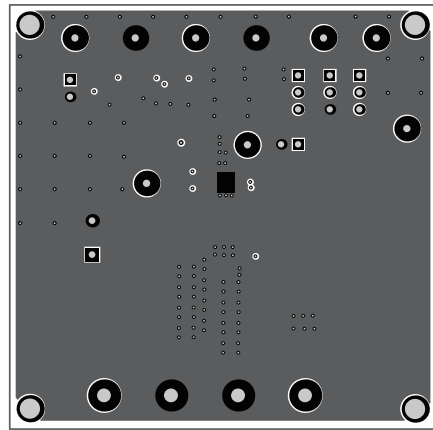

**Figure 4: Mid-Layer2**

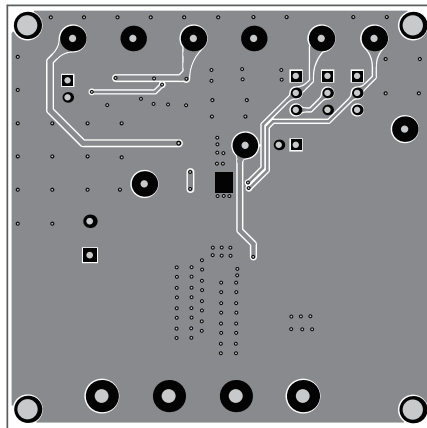

**Figure 5: Bottom Layer**

## QUICK START GUIDE

1. Preset driver power supply voltage range of 9V-16V.
2. Preset input power supply voltage range of 0V-100V.
3. Attach a couple of complementary PWMs with proper dead time to the CN4.
4. Attach driver power supply to the VDD and GND terminals respectively.
5. Attach input power supply to the VIN and GND terminals respectively.
6. Attach load to the LOAD and GND terminals respectively.
7. Turn on driver power supply.

Check INH, INL, DRVH and DRVL signals, make sure a sufficient dead time of DRVH and DRVL has been established before following steps:

8. Turn on input power supply.
9. Turn on the load, check output voltage and current.
10. To turn off the system, please follow these steps:
  - a. Turn off load.
  - b. Turn off VIN.
  - c. Turn off VDD.

**NOTICE:** The information in this document is subject to change without notice. Users should warrant and guarantee that third party Intellectual Property rights are not infringed upon when integrating MPS products into any application. MPS will not assume any legal responsibility for any said applications.