

DESCRIPTION

The MP2148 is a monolithic, step-down, switch-mode converter with built-in internal power MOSFETs. It achieves 1A continuous output current from a 2.3V-to-5.5V input voltage with excellent load and line regulation. The output voltage can be regulated to as low as 0.6V.

The Constant-On-Time control scheme provides fast transient response and eases loop stabilization. Fault protections include cycle-by-cycle current limiting and thermal shutdown.

The MP2148 is available in an ultra-small QFN-6 (1.0mmx1.5mm) package and requires a minimal number of readily available standard external components.

The MP2148 is ideal for a wide range of applications including high performance DSPs, wireless power, portable and mobile devices, and other low-power systems.

ELECTRICAL SPECIFICATION

Parameter	Symbol	Value	Units
Input Voltage	V _{IN}	2.3 – 5.5	V
Output Voltage	V _{OUT}	1.2	V
Output Current	I _{OUT}	1	A

Note: V_{IN}<3.3V may need more input capacitor.

FEATURES

- Low I_q: 11µA
- 2.2MHz Switching Frequency
- EN for Power Sequencing
- Power Good Only for Fixed Output Version
- Wide 2.3V-to-5.5V Operating Input Range
- Output Adjustable from 0.6V
- Up to 1A Output Current
- 120mΩ and 80mΩ Internal Power MOSFET Switches
- Output Discharge
- 100% Duty Cycle
- Short-Circuit Protection with Hiccup Mode
- Stable with Low ESR Output Ceramic Capacitors
- Available in a QFN-6(1.0mmx1.5mm) Package

APPLICATIONS

- Wireless/Networking Cards
- Portable and Mobile Devices
- Battery Powered Devices
- Low Voltage I/O System Power

All MPS parts are lead-free, halogen free, and adhere to the RoHS directive. For MPS green status, please visit MPS website under Quality Assurance.

"MPS" and "The Future of Analog IC Technology" are Registered Trademarks of Monolithic Power Systems, Inc.

EV2148-QD-00B EVALUATION BOARD



Board Number	MPS IC Number
EV2148-QD-00B	MP2148GQD

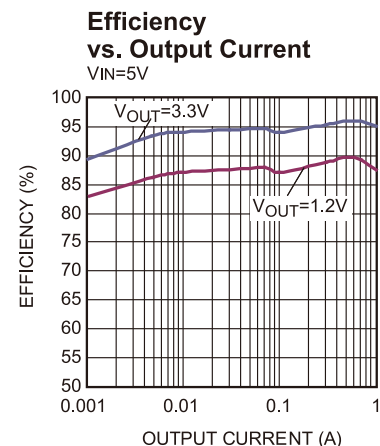

EVALUATION BOARD SCHEMATIC

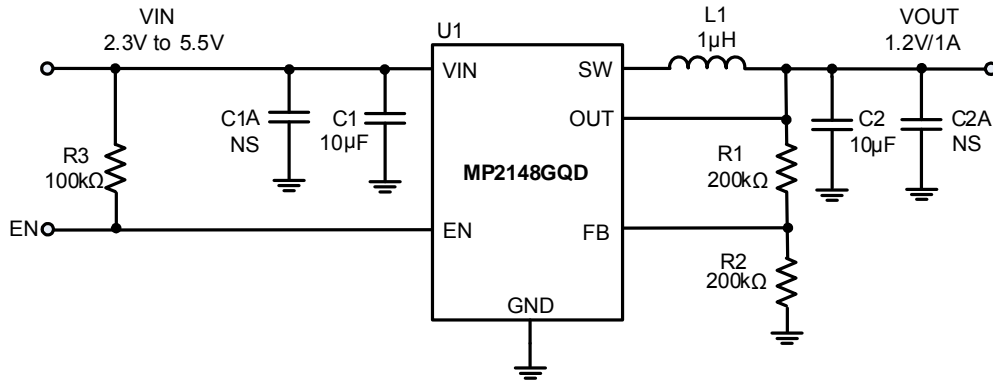

Figure 1—Typical Application Circuit for MP2148GQD

Note: $V_{IN} < 3.3V$ may need more input capacitor.

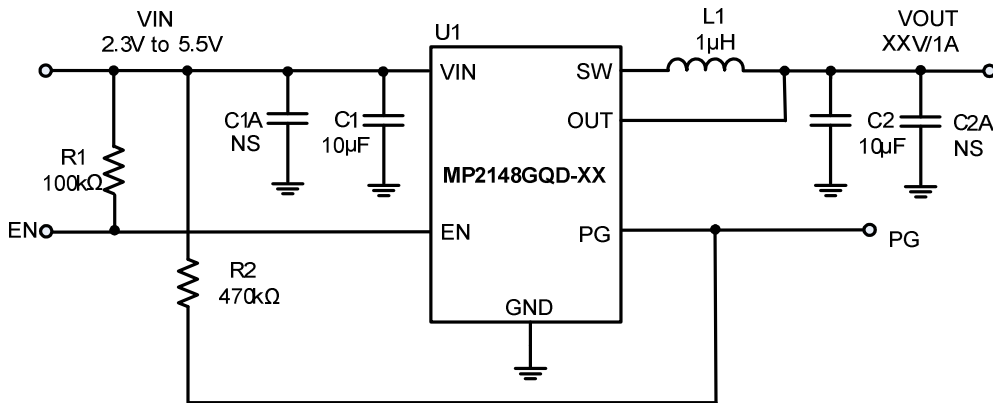

Figure 2—Typical Application Circuit for MP2148GQD-XX

Note: 1. $V_{IN} < 3.3V$ may need more input capacitor;
2. $V_{IN} > V_{OUT}$ for application.

EV2148-QD-00B BILL OF MATERIALS

Qty	RefDes	Value	Description	Package	Manufacturer	Manufacturer P/N
2	C1, C2	10 μ F	Ceramic Cap,10V,X5R	0805	muRata	GRM21BR61A106KE19L
1	R1	200k	Film Res.1%, For adjustable output reversion	0402	any	
		100k	Film Res.1% For fixed output reversion	0402	any	
1	R2	200k	Film Res.1% For adjustable output reversion	0402	any	
		470k	Film Res.1% For fixed output reversion	0402	any	
1	R3	100k	Film Res.1%	0402	any	
1	L1	1.0 μ H	Inductor, Rdc=45m Ω , Isat=3.8A	2520	CYNTEC CO. LTD.	PIFE25201B-1R0MS
1	U1		Step-down Switcher	QFN-6 1.0x1.5mm	MPS	MP2148GQD
0	C1A, C2A	NS				

EVB TEST RESULTS

Performance waveforms are tested on the evaluation board.

$V_{IN} = 5V$, $V_{OUT} = 1.2V$, $L = 1.0\mu H$, $T_A = +25^\circ C$, unless otherwise noted.

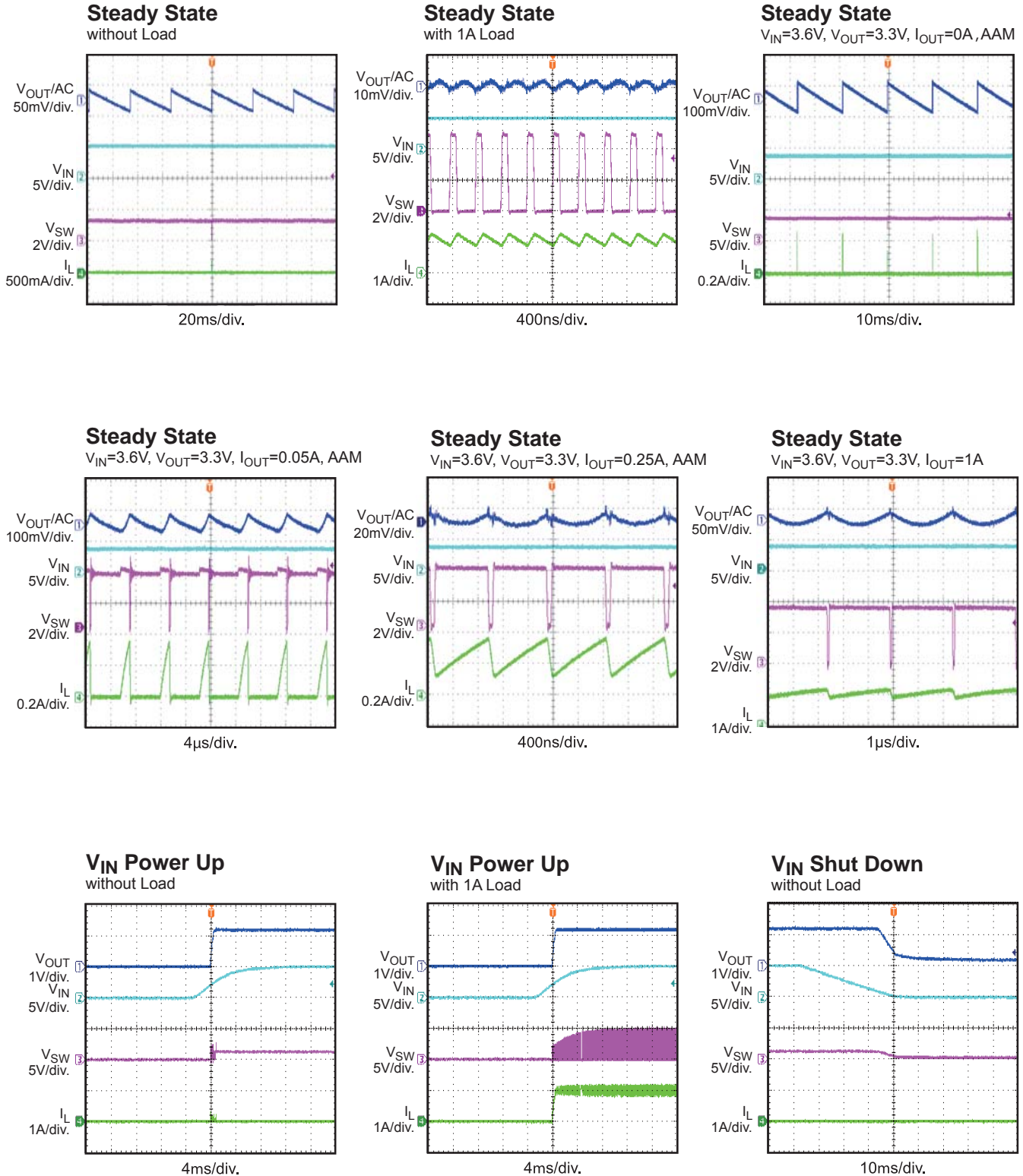

EVB TEST RESULTS (continued)

Performance waveforms are tested on the evaluation board.

$V_{IN} = 5V$, $V_{OUT} = 1.2V$, $L = 1.0\mu H$, $T_A = +25^\circ C$, unless otherwise noted.

V_{IN} Shut Down
with 1A Load

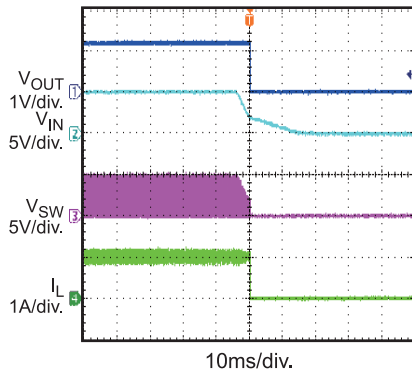

EN Start Up
without Load

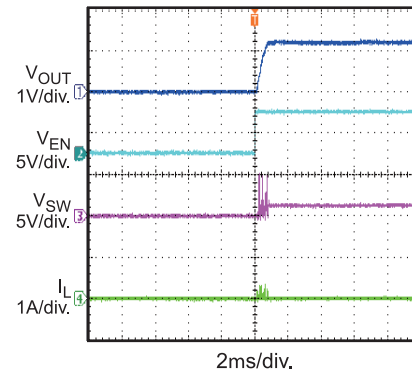

EN Start Up
with 1A Load

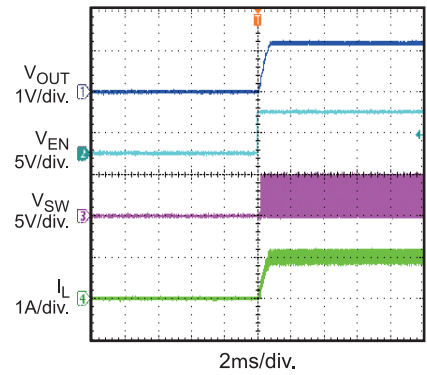

EN Shut Down
without Load

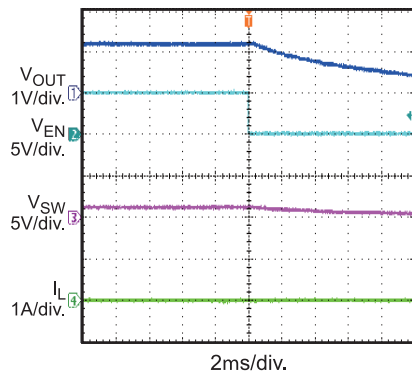

EN Shut Down
with 1A Load

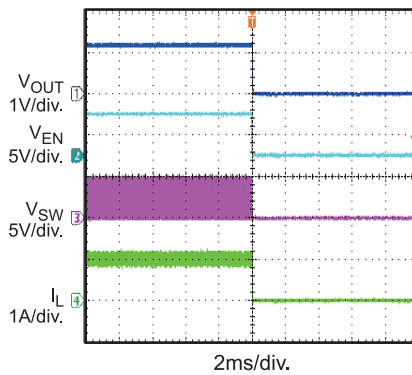

Load Transient Response
 $I_{OUT} = 0A$ to $1A$

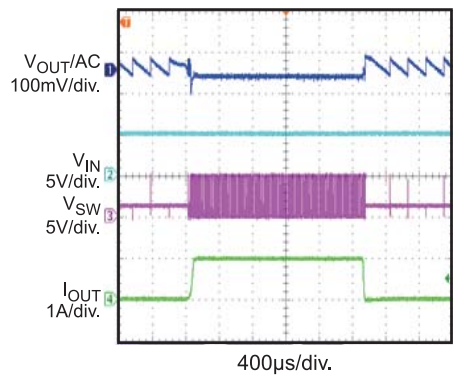

Load Transient Response
 $I_{OUT} = 0.5A$ to $1A$

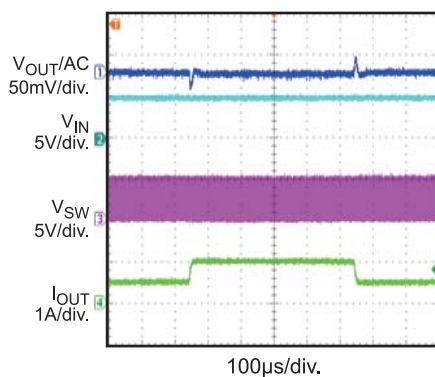

Short Circuit Entry

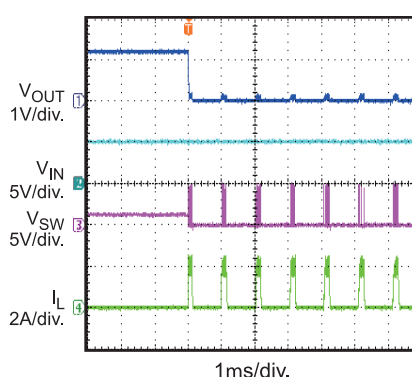

Short Circuit

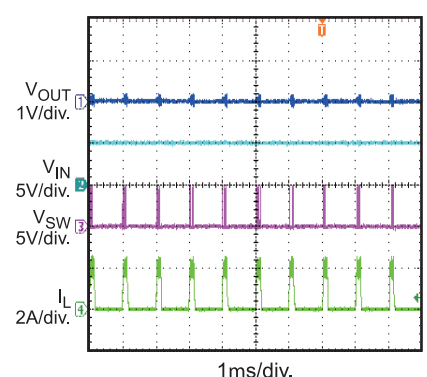

EVB TEST RESULTS *(continued)*

Performance waveforms are tested on the evaluation board.

V_{IN} = 5V, V_{OUT} = 1.2V, L = 1.0 μ H, T_A = +25°C, unless otherwise noted.

Short Circuit Recovery

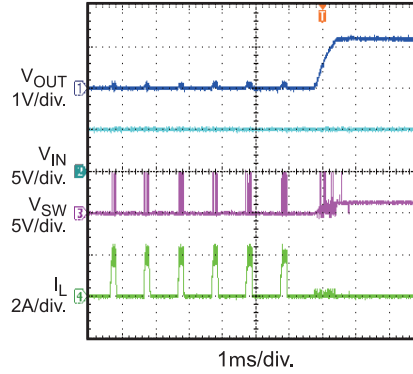

PRINTED CIRCUIT BOARD LAYOUT

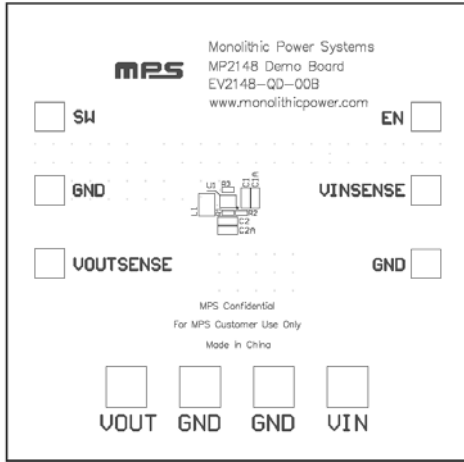

Figure 3—Top Silk Layer

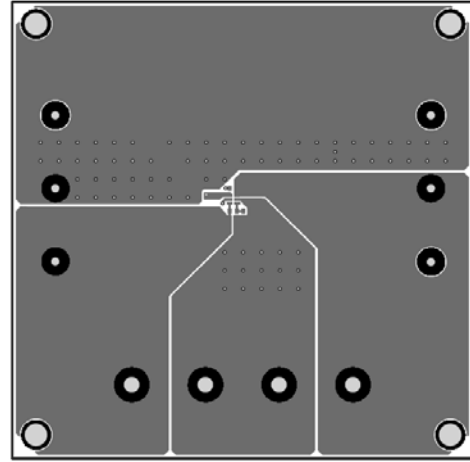

Figure 4—Top Layer

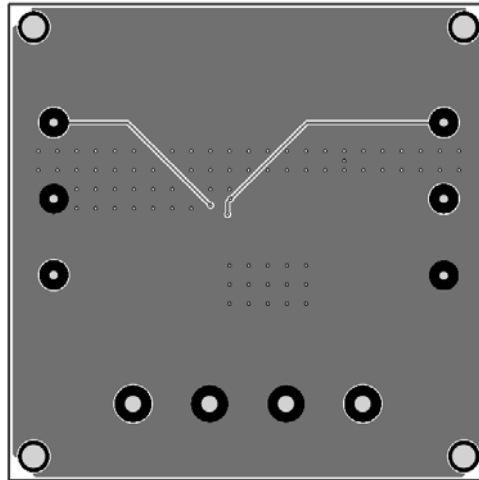

Figure 5—Bottom Layer

QUICK START GUIDE(MP2148GQD)

The output voltage of this board is set externally which can be regulated as low as 0.6V by operating from +2.3V to +5.5V input as the Figure 1. The default output voltage of this board is set to 1.2V.

1. Connect the positive and negative terminals of the load to the VOUT and GND pins, respectively.
2. Preset the power supply output between 2.3V and 5.5V, and then turn off the power supply.
3. Connect the positive and negative terminals of the power supply output to the VIN and GND pins, respectively.
4. Turn the power supply on. The board will automatically start up.
5. The Output Voltage can be changed by varying R2. Choose R1 to be around 120kΩ to 200kΩ. R2 is then given by:

$$R2 = \frac{R1}{\frac{V_{out}}{0.6} - 1}$$

Example: For Vout= 1.8V, R1=200kΩ, R2=100kΩ.

QUICK START GUIDE(MP2148GQD-XX)

MP2148GQD-12(-15,-18,-25,-33) board is fixed output voltage with PG function as the Figure 2:

1. Connect the positive and negative terminals of the load to the VOUT and GND pins, respectively.
2. Preset the power supply output between 2.3V and 5.5V, and then turn off the power supply.
3. Connect the positive and negative terminals of the power supply output to the VIN and GND pins, respectively.
4. Turn the power supply on. The board will automatically start up. Fixed output versions are shown in Table 1.

Table 1—Fixed output version information

Part Number	Fixed V _{OUT} (V)
MP2148GQD-12	1.2
MP2148GQD-15	1.5
MP2148GQD-18	1.8
MP2148GQD-25	2.5
MP2148GQD-33	3.3

NOTICE: The information in this document is subject to change without notice. Please contact MPS for current specifications. Users should warrant and guarantee that third party Intellectual Property rights are not infringed upon when integrating MPS products into any application. MPS will not assume any legal responsibility for any said applications.