

DESCRIPTION

The MP2164 is a monolithic step-down switch mode converter with built-in internal power MOSFETs. The DC-DC module has a small surface mount 2mm×2mm QFN12 package. It achieves 3A continuous output current from a 2.5V-to-5.5V input voltage with excellent load and line regulation. The output voltage can be regulated to as low as 0.6V.

The MP2164 is ideal for powering portable equipment that runs from a single cell Lithium-Ion (Li+) Battery.

The Constant-On-Time(COT) control scheme provides fast transient response high light-load efficiency and easy loop stabilization.

Fault condition protection includes output over voltage protection, cycle-by-cycle current limit and thermal shutdown.

ELECTRICAL SPECIFICATION

Parameter	Symbol	Value	Units
Input Voltage	V _{IN}	2.5 – 5.5	V
Output Voltage	V _{OUT}	1.2	V
Output Current	I _{OUT}	3	A

Note: V_{IN}<3.3V may need more input capacitor.

FEATURES

- Above 80% Light load efficiency
- Force PWM and Auto PFM operation
- Wide 2.5V-to-5.5V Operating Input Range
- Output Adjustable from 0.6V
- 100% Duty cycle in dropout
- Up to 3A Output Current
- 32mΩ and 20mΩ Internal Power MOSFET Switches
- 2.3MHz Frequency
- Short Circuits Protection with Hiccup Mode
- Thermal Shutdown
- Stable with Low ESR Output Ceramic Capacitors
- Available in a QFN-12(2mm×2mm) Package

APPLICATIONS

- Wireless/Networking Cards
- Smart phone
- Low Voltage I/O System Power

All MPS parts are lead-free, halogen free, and adhere to the RoHS directive. For MPS green status, please visit MPS website under Quality Assurance.

"MPS" and "The Future of Analog IC Technology" are Registered Trademarks of Monolithic Power Systems, Inc.

EV2164-G-00A EVALUATION BOARD



Efficiency vs. Output Current

V_{IN}=5V, DCR=14mΩ

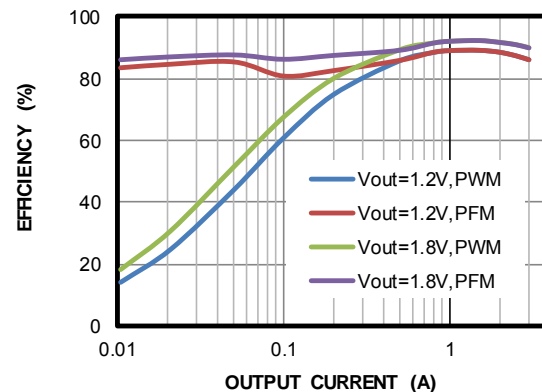

Board Number	MPS IC Number
EV2164-G-00A	MP2164GG

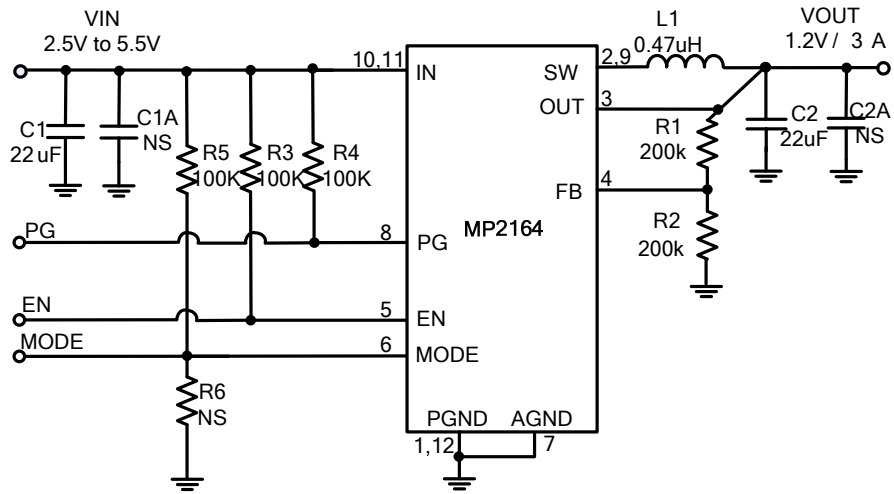
EVALUATION BOARD SCHEMATIC

Figure 1—Typical Application Circuit for MP2164GG

Note: $V_{IN} < 3.3V$ may need more input capacitor.

EV2164-G-00A BILL OF MATERIALS

Qty	RefDes	Value	Description	Package	Manufacturer	Manufacturer/PN
2	C1,C2	22 μ F	Ceramic Cap.,16V,X5R	0805	Murata	GRM21BR61C226ME44L
0	C1A, C2A	NS				
2	R1,R2	200k	Film Res,1%,0603,200K	0603	YAGEO	RC0603FR-07200KL
3	R3,R4, R5	100k	Film Res,1%,0603,100K	0603	YAGEO	RC0603FR-07100KL
0	R6	NS				
1	L1	0.47 μ H	Inductor,RDC=14mOhm, Isat=14.5A	4040	WE	74437324047
1	U1	MP2164	Synchronous Step-Down Converter	QFN-12	MPS	MP2164GG

EVB TEST RESULTS

Performance waveforms are tested on the evaluation board.

$V_{IN} = 5V$, $V_{OUT} = 1.2V$, $L = 0.47\mu H$, $C_{OUT} = 22\mu F$, $T_A = +25^\circ C$, unless otherwise noted.

Steady State

$I_{OUT} = 0A$, PWM

CH1: V_{OUT}/AC
20mV/div.

CH2: V_{IN}
5V/div.

CH3: V_{SW}
5V/div.

CH4: I_L
2A/div.

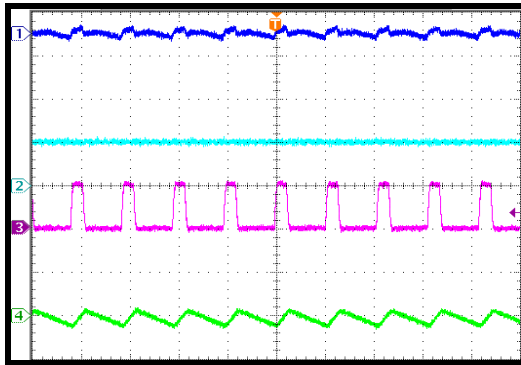

400ns/div.

Steady State

$I_{OUT} = 3A$, PWM

CH1: V_{OUT}/AC
20mV/div.

CH2: V_{IN}
5V/div.

CH3: V_{SW}
5V/div.

CH4: I_L
2A/div.

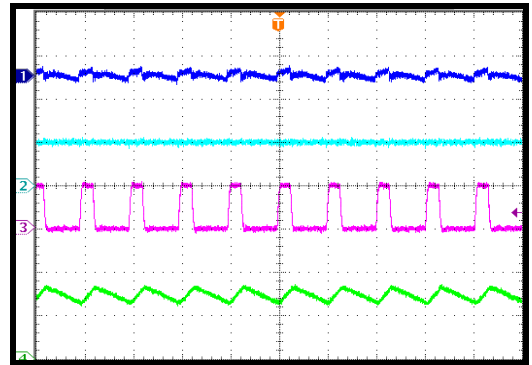

400ns/div.

Steady State

$I_{OUT} = 0A$, PFM

CH1: V_{OUT}/AC
50mV/div.

CH2: V_{IN}
5V/div.

CH3: V_{SW}
5V/div.

CH4: I_L
1A/div.

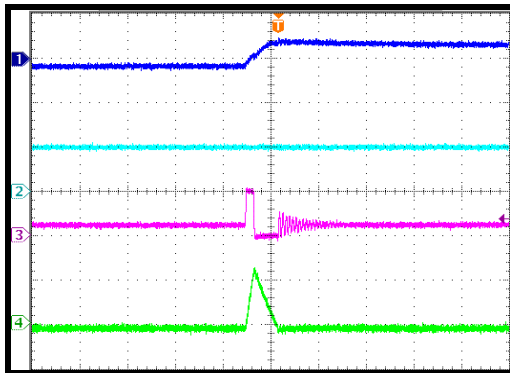

1µs/div.

VIN Power-Up

$I_{OUT} = 0A$, PWM

CH1: V_{OUT}
1V/div.

CH2: V_{IN}
5V/div.

CH3: V_{SW}
5V/div.

CH4: I_L
2A/div.

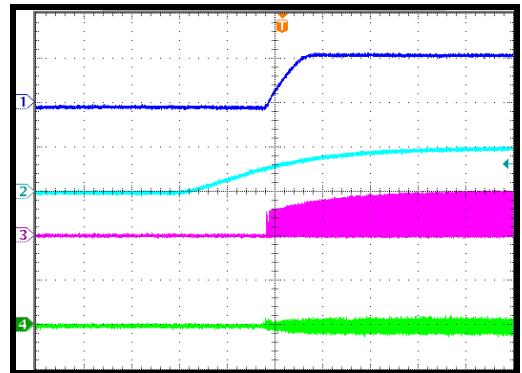

2ms/div.

VIN Power-Up

$I_{OUT} = 3A$, PWM

CH1: V_{OUT}
1V/div.

CH2: V_{IN}
5V/div.

CH3: V_{SW}
5V/div.

CH4: I_L
2A/div.

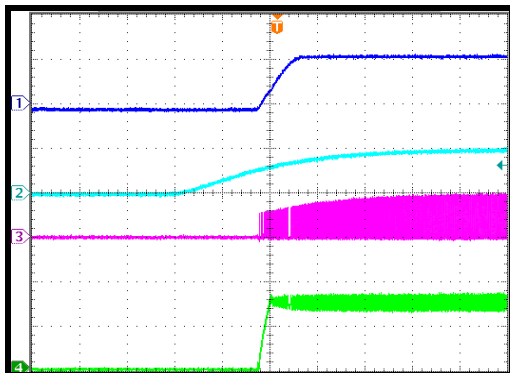

2ms/div.

VIN Power-Up

$I_{OUT} = 0A$, PFM

CH1: V_{OUT}
1V/div.

CH2: V_{IN}
5V/div.

CH3: V_{SW}
5V/div.

CH4: I_L
1A/div.

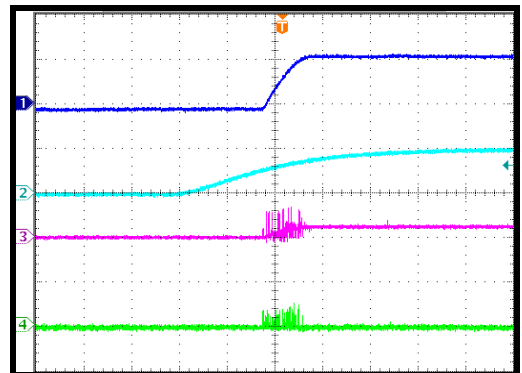

2ms/div.

EVB TEST RESULTS (continued)

Performance waveforms are tested on the evaluation board.

$V_{IN} = 5V$, $V_{OUT} = 1.2V$, $L = 0.47\mu H$, $C_{OUT} = 22\mu F$, $T_A = +25^\circ C$, unless otherwise noted.

VIN Shutdown

$I_{OUT} = 0A$, PWM

CH1: V_{OUT}
1V/div.
CH2: V_{IN}
5V/div.
CH3: V_{SW}
5V/div.
CH4: I_L
2A/div.

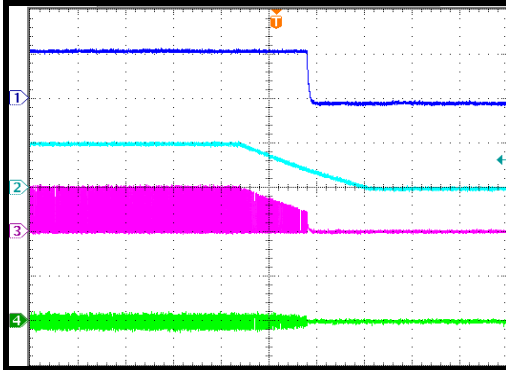

40ms/div.

VIN Shutdown

$I_{OUT} = 3A$, PWM

CH1: V_{OUT}
1V/div.
CH2: V_{IN}
5V/div.
CH3: V_{SW}
5V/div.
CH4: I_L
2A/div.

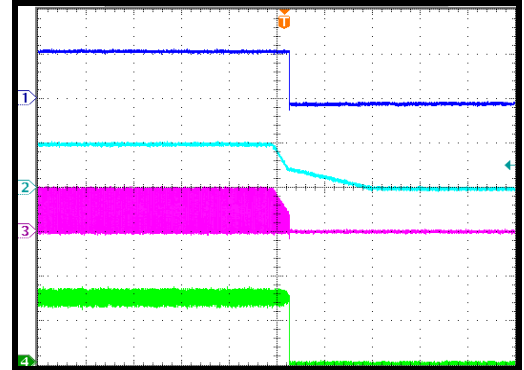

10ms/div.

VIN Shutdown

$I_{OUT} = 0A$, PFM

CH1: V_{OUT}
1V/div.
CH2: V_{IN}
5V/div.
CH3: V_{SW}
5V/div.
CH4: I_L
2A/div.

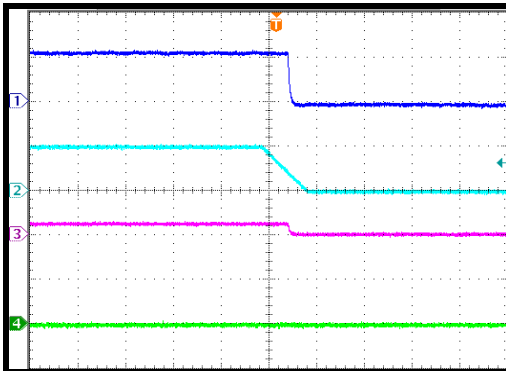

40ms/div.

PG On

$I_{OUT} = 0A$, PWM

CH1: V_{OUT}
1V/div.
CH2: V_{PG}
5V/div.
CH3: V_{SW}
5V/div.
CH4: I_L
2A/div.

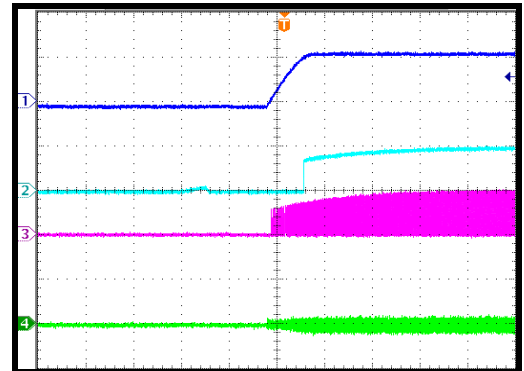

2ms/div.

PG On

$I_{OUT} = 3A$, PWM

CH1: V_{OUT}
1V/div.
CH2: V_{PG}
5V/div.
CH3: V_{SW}
5V/div.
CH4: I_L
2A/div.

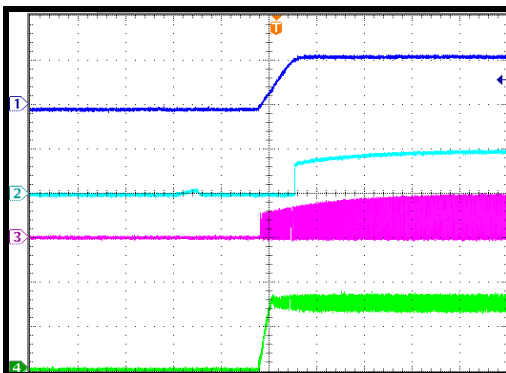

2ms/div.

PG On

$I_{OUT} = 0A$, PFM

CH1: V_{OUT}
1V/div.
CH2: V_{PG}
5V/div.
CH3: V_{SW}
5V/div.
CH4: I_L
1A/div.

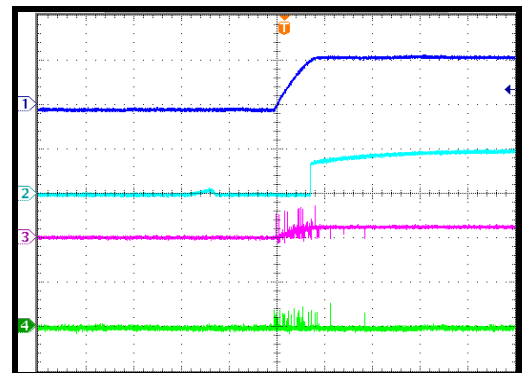

2ms/div.

EVB TEST RESULTS (continued)

Performance waveforms are tested on the evaluation board.

$V_{IN} = 5V$, $V_{OUT} = 1.2V$, $L = 0.47\mu H$, $C_{OUT} = 22\mu F$, $T_A = +25^\circ C$, unless otherwise noted.

PG Off
 $I_{OUT} = 0A$, PWM

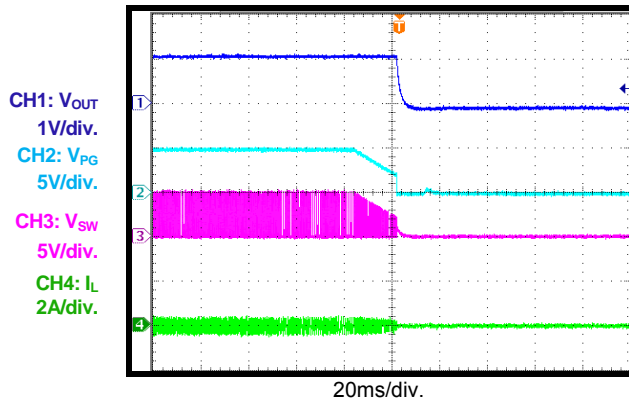

PG Off
 $I_{OUT} = 3A$, PWM

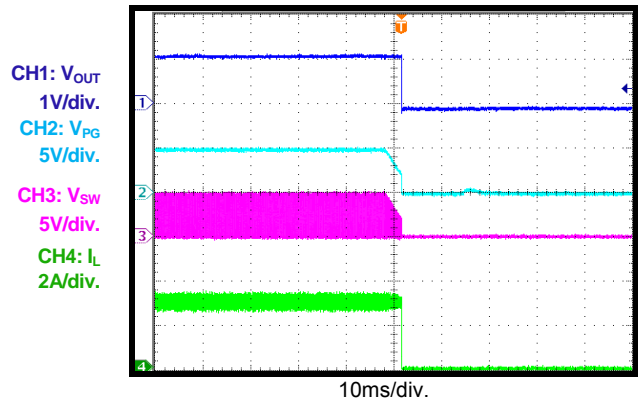

PG Off
 $I_{OUT} = 0A$, PFM

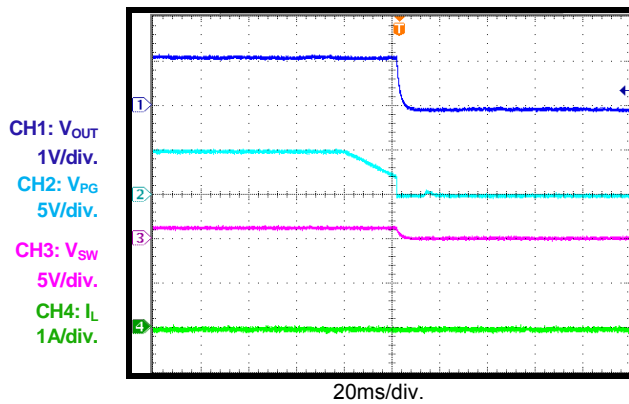

EN On
 $I_{OUT} = 0A$, PWM

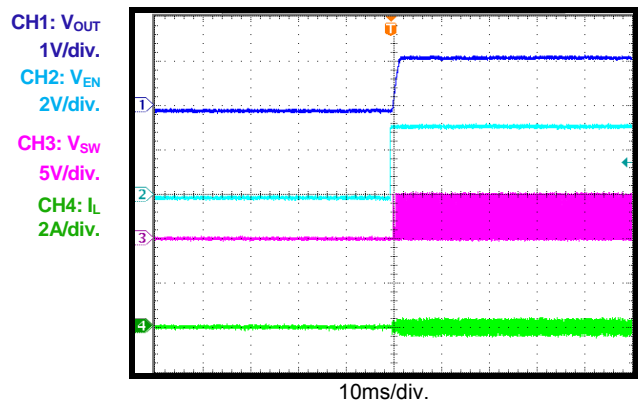

EN On
 $I_{OUT} = 3A$, PWM

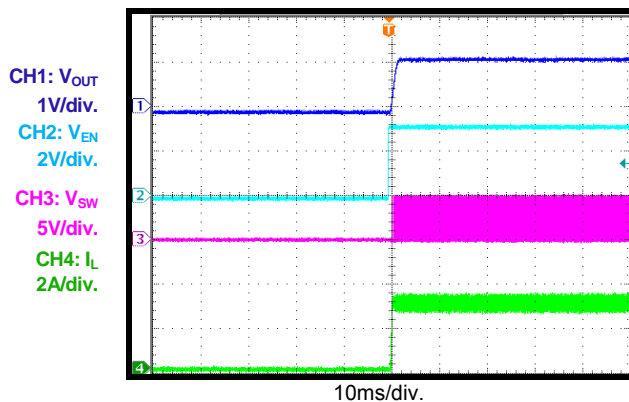

EN On
 $I_{OUT} = 0A$, PFM

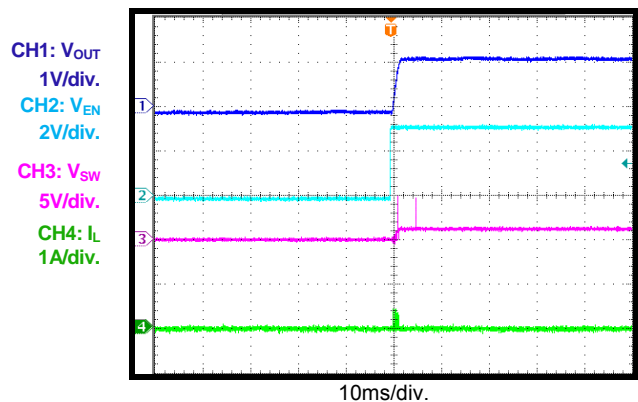

EVB TEST RESULTS (continued)

Performance waveforms are tested on the evaluation board.

$V_{IN} = 5V$, $V_{OUT} = 1.2V$, $L = 0.47\mu H$, $C_{OUT} = 22\mu F$, $T_A = +25^\circ C$, unless otherwise noted.

EN Off
 $I_{OUT} = 0A$, PWM

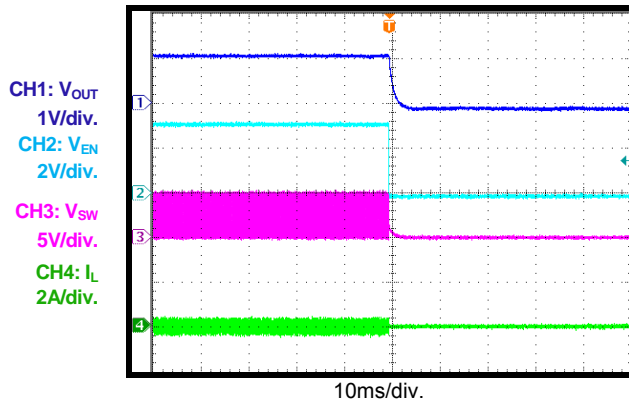

EN Off
 $I_{OUT} = 3A$, PWM

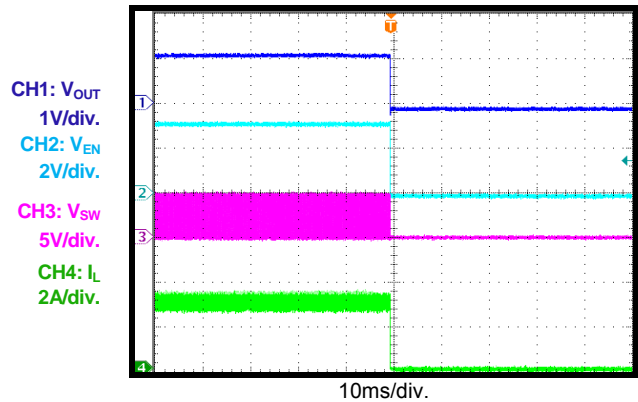

EN Off
 $I_{OUT} = 0A$, PFM

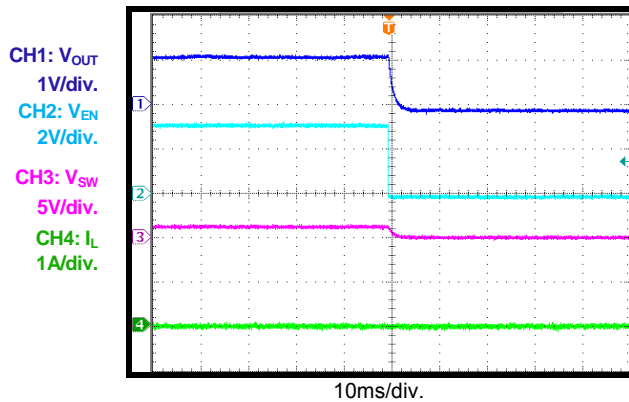

Load Transient
 $I_{OUT} = 0A$ to $3A$, $2.5A/\mu s$, PWM

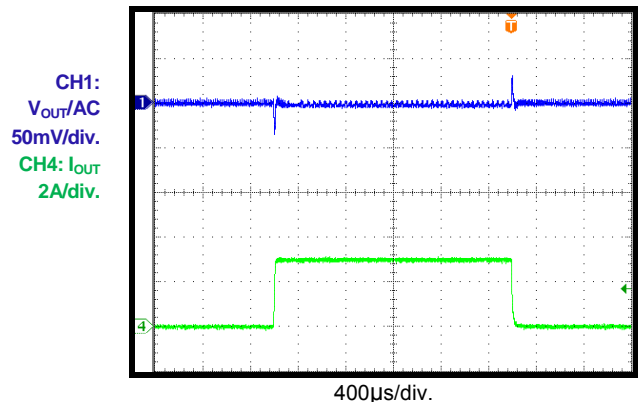

Load Transient
 $I_{OUT} = 1.5A$ to $3A$, $2.5A/\mu s$, PWM

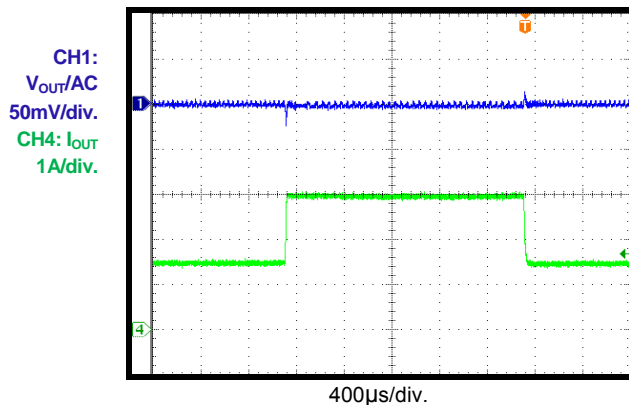

Load Transient
 $I_{OUT} = 0A$ to $3A$, $2.5A/\mu s$, PFM

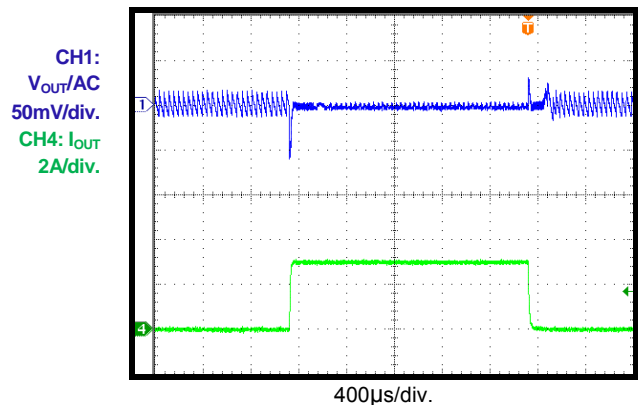

EVB TEST RESULTS (continued)

Performance waveforms are tested on the evaluation board.

$V_{IN} = 5V$, $V_{OUT} = 1.2V$, $L = 0.47\mu H$, $C_{OUT} = 22\mu F$, $T_A = +25^\circ C$, unless otherwise noted.

Short-Circuits Entry

PWM

CH1: V_{OUT}
1V/div.
CH2: V_{PG}
5V/div.
CH3: V_{SW}
5V/div.
CH4: I_L
5A/div.

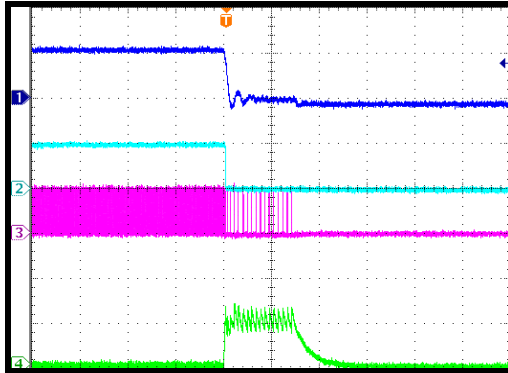

40µs/div.

Short-Circuits Steady State

CH1: V_{OUT}
1V/div.
CH2: V_{PG}
5V/div.
CH3: V_{SW}
5V/div.
CH4: I_L
5A/div.

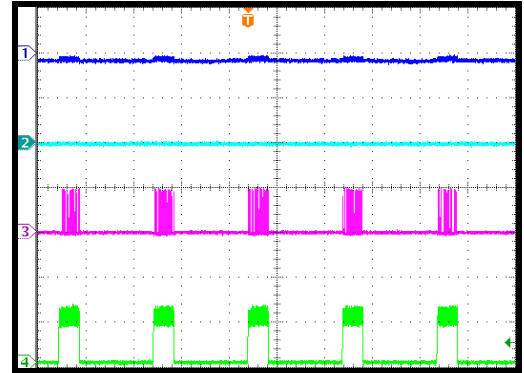

10ms/div.

Short-Circuits Recovery

PWM

CH1: V_{OUT}
1V/div.
CH2: V_{PG}
5V/div.
CH3: V_{SW}
5V/div.
CH4: I_L
5A/div.

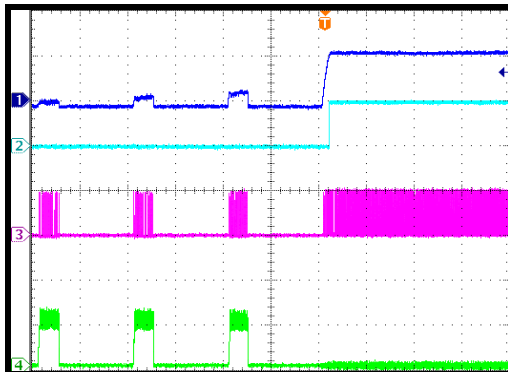

10ms/div.

Short-Circuits Entry

PFM

CH1: V_{OUT}
1V/div.
CH2: V_{PG}
5V/div.
CH3: V_{SW}
5V/div.
CH4: I_L
5A/div.

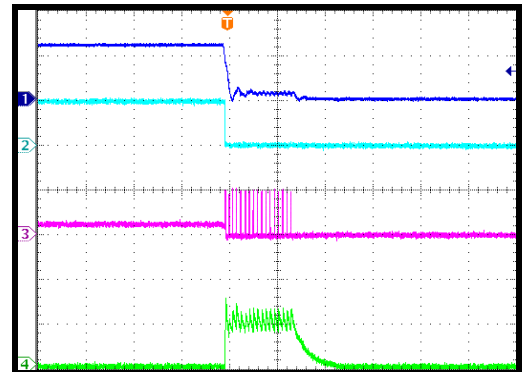

40µs/div.

Short-Circuits Recovery

PFM

CH1: V_{OUT}
1V/div.
CH2: V_{PG}
5V/div.
CH3: V_{SW}
5V/div.
CH4: I_L
5A/div.

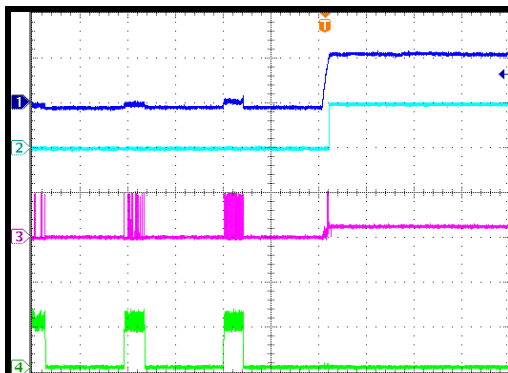

10ms/div.

CIRCUIT BOARD LAYOUT

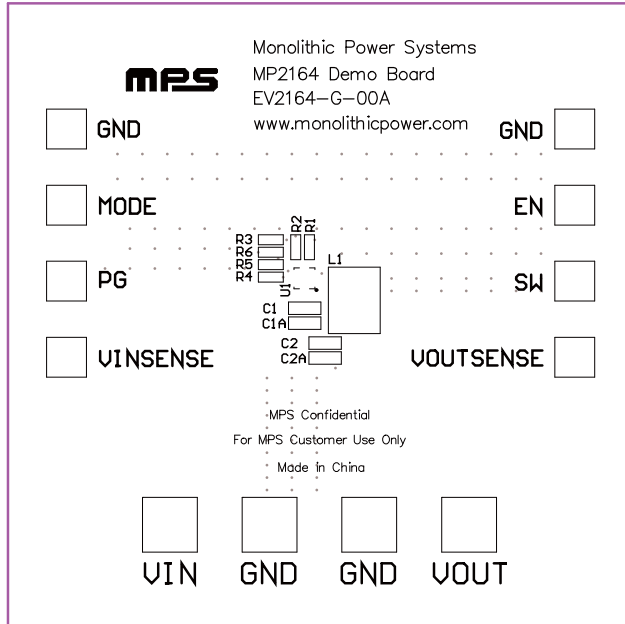

Figure 3—Top Silk Layer

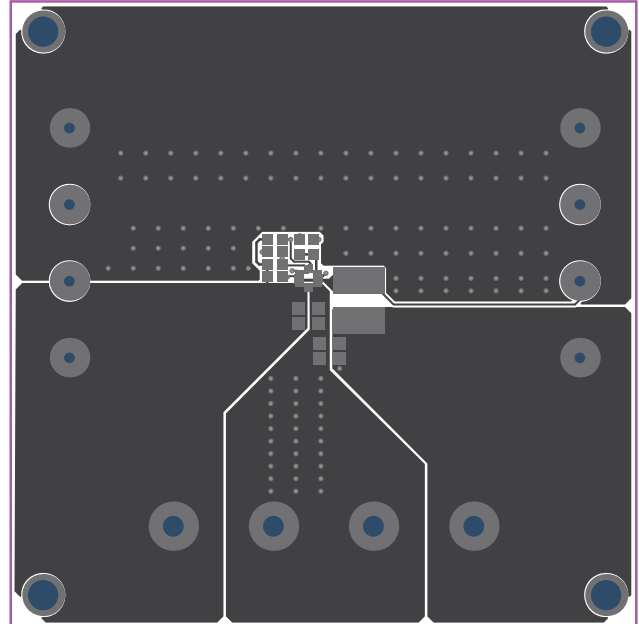

Figure 4—Top Layer

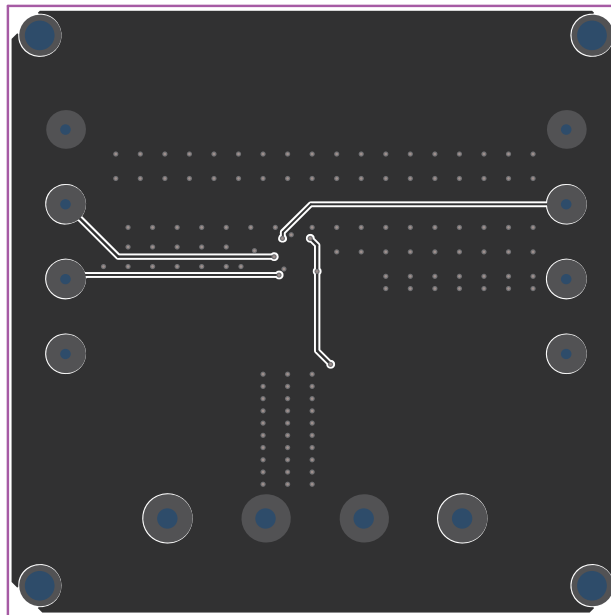

Figure 5—Bottom Layer

QUICK START GUIDE (MP2164GG)

The output voltage of this board is set externally which can be regulated as low as 0.6V by operating from +2.5V to +5.5V input. The default output voltage of this board is set to 1.2V.

1. Connect the positive and negative terminals of the load to the VOUT and GND pins, respectively.
2. Preset the power supply output between 2.5V and 5.5V, and then turn off the power supply.
3. Connect the positive and negative terminals of the power supply output to the VIN and GND pins, respectively.
4. Turn the power supply on. The board will automatically start up.
5. The Output Voltage can be changed by varying R2. Choose R1 to 200k typically. R2 is then given by:

$$R2 = \frac{R1}{\frac{V_{out}}{0.6} - 1}$$

Example: For Vout= 1.8V, R1=200kΩ, R2=100kΩ.

NOTICE: The information in this document is subject to change without notice. Please contact MPS for current specifications. Users should warrant and guarantee that third party Intellectual Property rights are not infringed upon when integrating MPS products into any application. MPS will not assume any legal responsibility for any said applications.