

### DESCRIPTION

The MP2182 is a monolithic, step-down, switch-mode converter with built-in internal power MOSFETs. It achieves 1A continuous output current from a 2.5V-to-5.5V input voltage with excellent load and line regulation. The output voltage can be regulated to as low as 0.6V.

The Constant-On-Time control scheme provides fast transient response and eases loop stabilization. Fault protections include cycle-by-cycle current limiting and thermal shutdown.

The MP2182 is available in an ultra-small SOT583 package and requires a minimal number of readily available standard external components.

The MP2182 is ideal for a wide range of applications including high performance DSPs, wireless power, portable and mobile devices, and other low-power systems.

### ELECTRICAL SPECIFICATION

Parameter	Symbol	Value	Units
Input Voltage	$V_{IN}$	2.5 – 5.5	V
Output Voltage	$V_{OUT}$	1.2	V
Output Current	$I_{OUT}$	2A	A

Note:  $V_{IN} < 3.3V$  may need more input capacitor.

### FEATURES

- Low  $I_q$ : 21 $\mu$ A
- 1.2MHz Switching Frequency
- EN for Power Sequencing
- 1% FB Accuracy
- Wide 2.5V-to-5.5V Operating Input Range
- Output Adjustable from 0.6V
- Up to 2A Output Current
- 80m $\Omega$  and 40m $\Omega$  Internal Power MOSFET Switches
- 100% Duty On
- Output Discharge
- $V_o$  OVP
- External Soft Start Control
- Short-Circuit Protection with Hiccup Mode
- Power Good
- Available in a SOT583 Package

### APPLICATIONS

- Wireless/Networking Cards
- Portable Instruments
- Battery Powered Devices
- Low Voltage I/O System Power
- Multi Function Printer

All MPS parts are lead-free, halogen free, and adhere to the RoHS directive. For MPS green status, please visit MPS website under Quality Assurance.

“MPS” and “The Future of Analog IC Technology” are Registered Trademarks of Monolithic Power Systems, Inc.

### EV2182-TL-00A EVALUATION BOARD

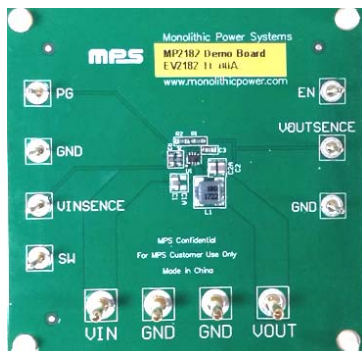

Board Number	MPS IC Number
EV2182-TL-00A	MP2182GTL

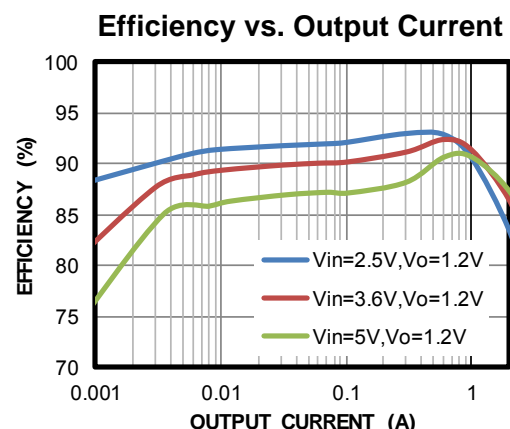

## EVALUATION BOARD SCHEMATIC

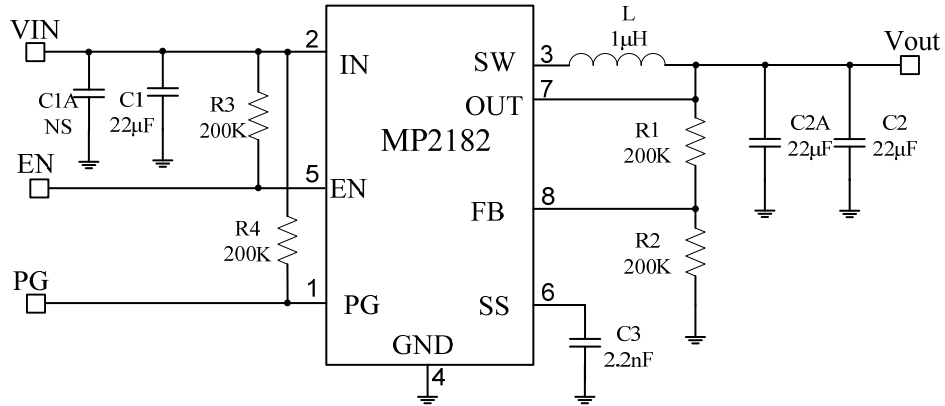

**Figure 1—Typical Application Circuit for MP2182GTL**

Note:  $V_{IN} < 3.3V$  may need more input capacitor.

## EV2182-TL-00A BILL OF MATERIALS

TABLE 1. MP2182GTL BILL OF MATERIALS

Qty	RefDes	Value	Description	Package	Manufacturer	Manufacturer/PN
0	C2A2A	NS				
3	C1,C2, C2A	22µF	Ceramic Cap.,16V,X5R	0805	Murata	GRM21BR61C226ME44L
1	C3	2.2nF	Ceramic Cap.,50V,X7R	0603	Murata	GRM188R71H222KA01D
4	R1,R2, R3,R4	200K	Film Res,1%,0603,200K	0603	YAGEO	RC0603FR-07200KL
1	L	1µH	Inductor,RDC=27mOhm, Isat=9.0A	4020	WE	74437324010
1	U1	MP2182	Synchronous Step-Down switcher	SOT583	MPS	MP2182GTL

## EVB TEST RESULTS

Performance waveforms are tested on the evaluation board.

$V_{IN} = 5V$ ,  $V_{OUT} = 1.2V$ ,  $L = 1.0\mu H$ ,  $C_{OUT} = 2 \times 22\mu F$ ,  $T_A = +25^\circ C$ , unless otherwise noted.

### Steady State

$I_{OUT} = 0.2A$

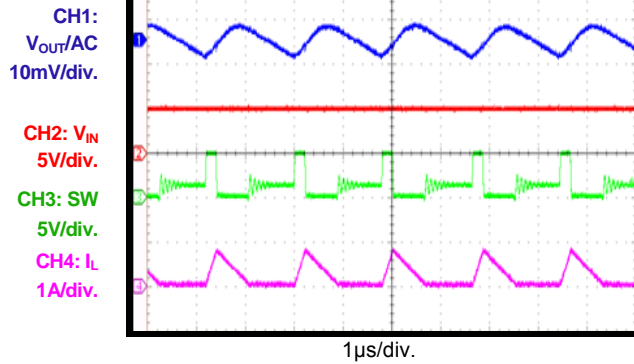

### Steady State

$I_{OUT} = 1A$

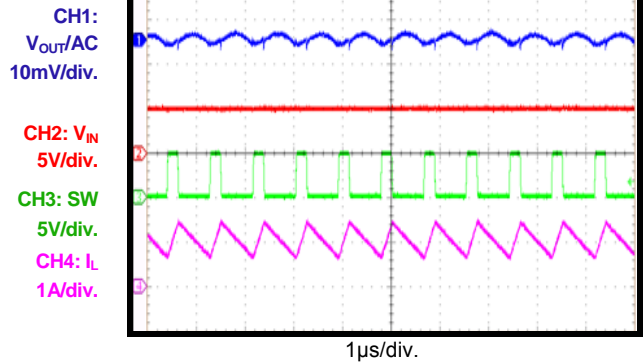

### Steady State

$I_{OUT} = 1A$

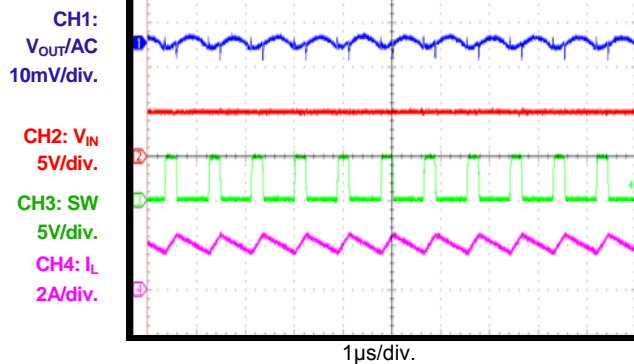

### VIN Power ON

$I_{OUT} = 0A$

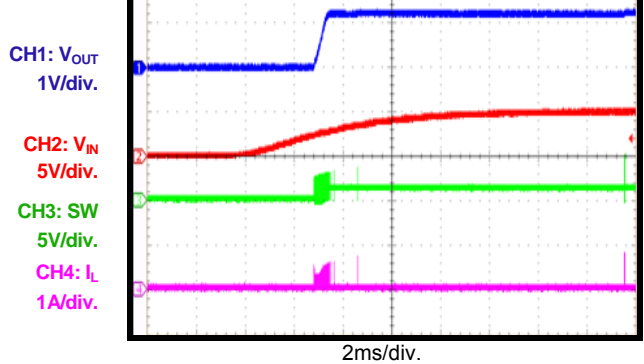

### VIN Power ON

$I_{OUT} = 2A$

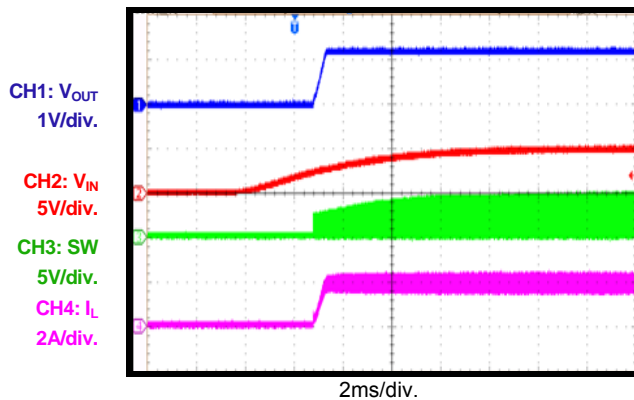

### VIN Power OFF

$I_{OUT} = 0A$

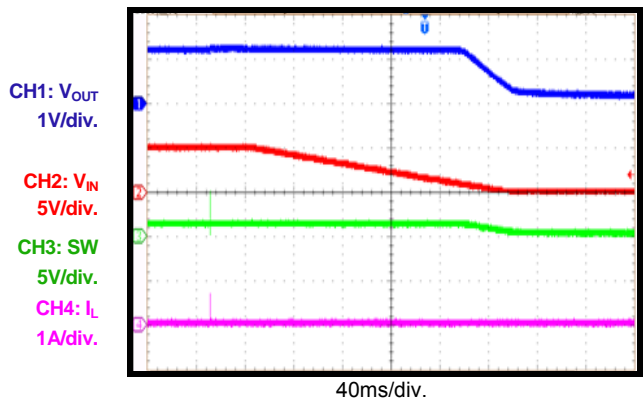

## EVB TEST RESULTS (continued)

Performance waveforms are tested on the evaluation board.

$V_{IN} = 5V$ ,  $V_{OUT} = 1.2V$ ,  $L = 1.0\mu H$ ,  $C_{OUT} = 2 \times 22\mu F$ ,  $T_A = +25^\circ C$ , unless otherwise noted.

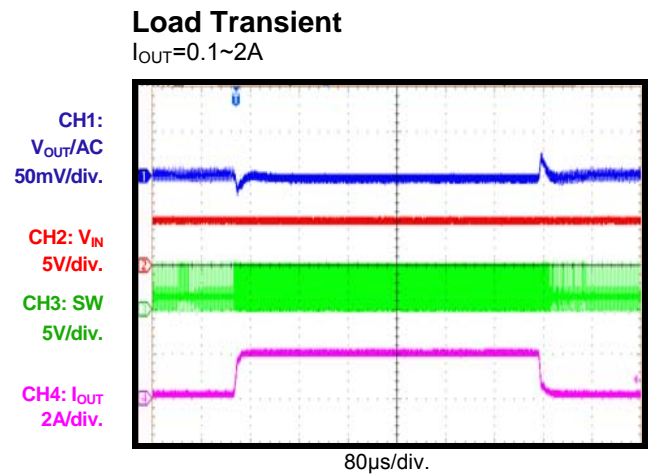
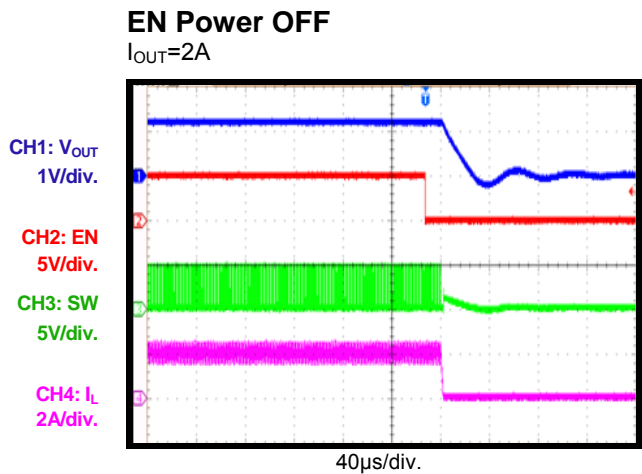
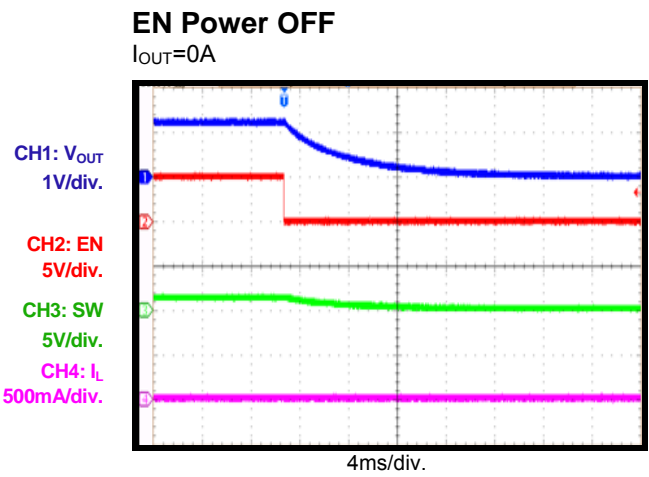
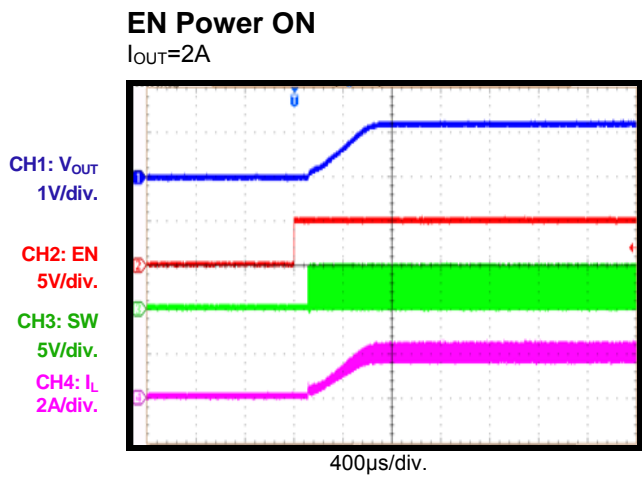
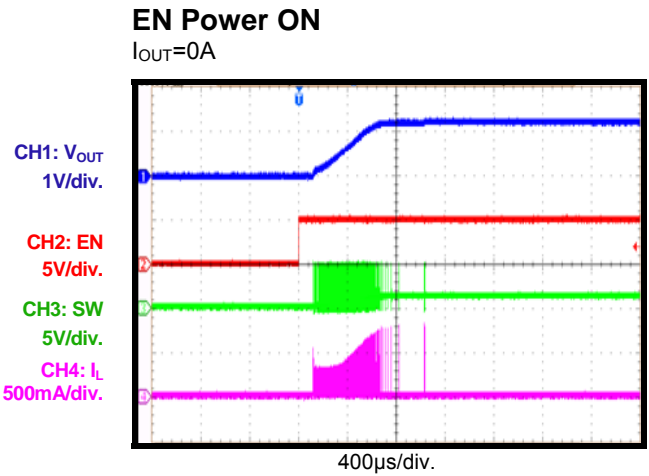
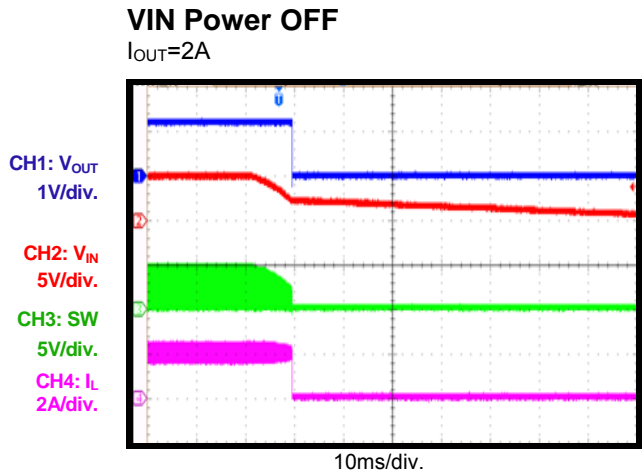

## EVB TEST RESULTS (continued)

Performance waveforms are tested on the evaluation board.

$V_{IN} = 5V$ ,  $V_{OUT} = 1.2V$ ,  $L = 1.0\mu H$ ,  $C_{OUT} = 2 \times 22\mu F$ ,  $T_A = +25^\circ C$ , unless otherwise noted.

### Load Transient

$I_{OUT} = 1 \sim 2A$

CH1:  $V_{OUT}/AC$   
20mV/div.

CH2:  $V_{IN}$   
5V/div.

CH3: SW  
5V/div.

CH4:  $I_{OUT}$   
2A/div.

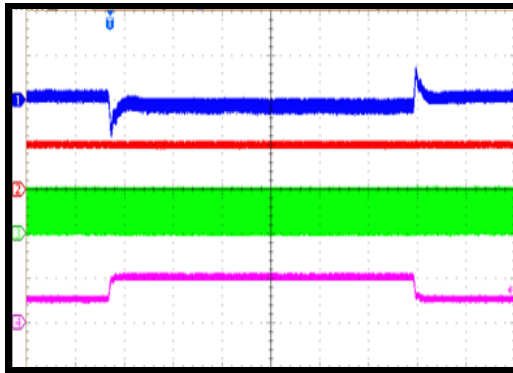

### Short Entry

CH1:  $V_{OUT}$   
1V/div.

CH2:  $V_{IN}$   
5V/div.

CH3: SW  
5V/div.

CH4:  $I_L$   
5A/div.

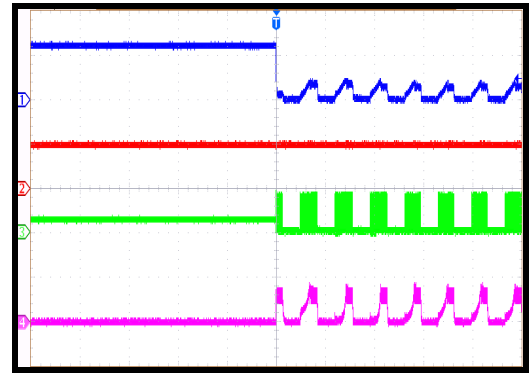

### Short State

CH1:  $V_{OUT}$   
1V/div.

CH2:  $V_{IN}$   
5V/div.

CH3: SW  
5V/div.

CH4:  $I_L$   
5A/div.

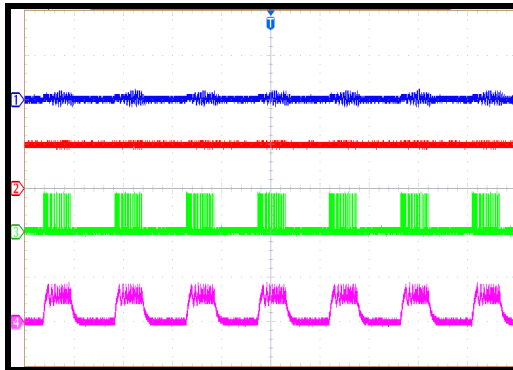

### Short Recovery

CH1:  $V_{OUT}$   
1V/div.

CH2:  $V_{IN}$   
5V/div.

CH3: SW  
5V/div.

CH4:  $I_L$   
5A/div.

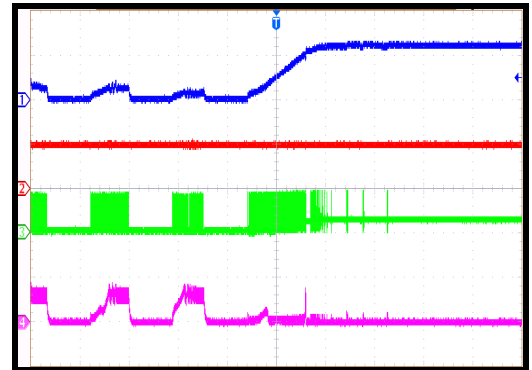

### CIRCUIT BOARD LAYOUT

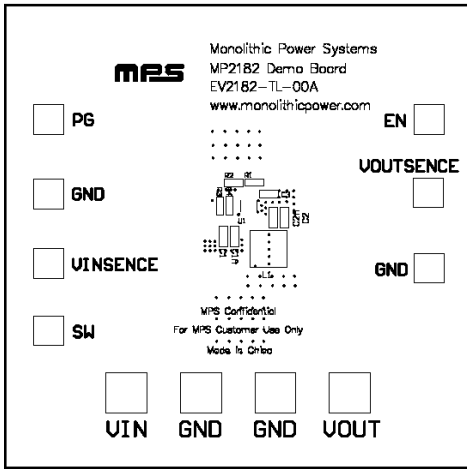

Figure 3—Top Silk Layer

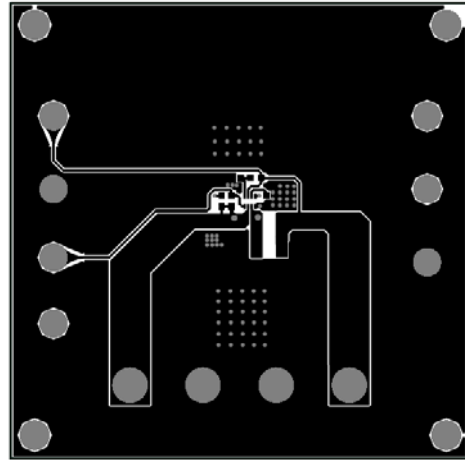

Figure 4—Top Layer

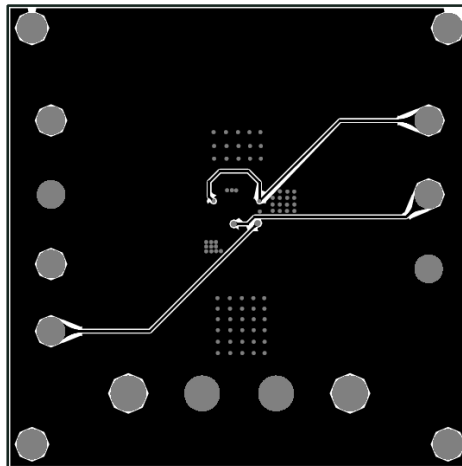

Figure 5—Bottom Layer

## QUICK START GUIDE (MP2182GTL )

The output voltage of this board is set externally which can be regulated as low as 0.6V by operating from +2.5V to +5.5V input. The default output voltage of this board is set to 1.2V.

1. Connect the positive and negative terminals of the load to the VOUT and GND pins, respectively.
2. Preset the power supply output between 2.5V and 5.5V, and then turn off the power supply.
3. Connect the positive and negative terminals of the power supply output to the VIN and GND pins, respectively.
4. Turn the power supply on. The board will automatically start up.
5. The Output Voltage can be changed by varying R2. Choose R1 to 200k typically. R2 is then given by:

$$R2 = \frac{R1}{\frac{V_{out}}{0.6} - 1}$$

Example: For Vout= 1.8V, R1=200kΩ, R2=100kΩ.

**NOTICE:** The information in this document is subject to change without notice. Please contact MPS for current specifications. Users should warrant and guarantee that third party Intellectual Property rights are not infringed upon when integrating MPS products into any application. MPS will not assume any legal responsibility for any said applications.