



The Future of Analog IC Technology®

EV2225-J-00A

High-Efficiency, 5A, 18V, 500kHz Sync. Step-Down Switch Evaluation Board

DESCRIPTION

The EV2225-J-00A demonstrates MPS's MP2225, a high-frequency, synchronous, rectified, step-down converter with built-in high-side and low-side power MOSFETs. The MP2225 offers a very compact solution to achieve a 5A continuous output current with excellent load and line regulation over a wide input supply range. The MP2225 has synchronous mode operation for higher efficiency over the output current load range.

Current-mode operation provides fast transient response and eases loop stabilization.

Full protection features includes over-current protection and thermal shutdown.

The MP2225 is available in a space-saving 8-pin TSOT23 package.

ELECTRICAL SPECIFICATION

Parameter	Symbol	Value	Units
Input Voltage	V_{IN}	4.5 – 18	V
Output Voltage	V_{OUT}	3.3	V
Output Current	I_{OUT}	5	A

FEATURES

- Wide 4.5V-to-18V Operating Input Range
- Adjustable Output Voltage From 0.6V
- 5A Continuous Output Current
- 47mΩ/18mΩ Low $R_{DS(ON)}$ Internal Power MOSFETs
- High Efficiency Up to 97%
- Fixed 500kHz Switching Frequency
- Synchronizes from a 200kHz-to-2MHz External Clock
- 2.4ms Internal Soft-Start Time
- 1% Reference Accuracy In Room Temperature
- Power-Save Mode
- OCP Protection and Hiccup
- Available in 8-pin TSOT23

APPLICATIONS

- Flat-Panel Television and Monitors
- Notebook System and I/O Power
- Digital Set-Top Boxes
- Distributed Power Systems

All MPS parts are lead-free and adhere to the RoHS directive. For MPS green status, please visit MPS website under Quality Assurance. "MPS" and "The Future of Analog IC Technology", are Registered Trademarks of Monolithic Power Systems, Inc.

EV2225-J-00A EVALUATION BOARD



Board Number	MPS IC Number
EV2225-J-00A	MP2225DJ

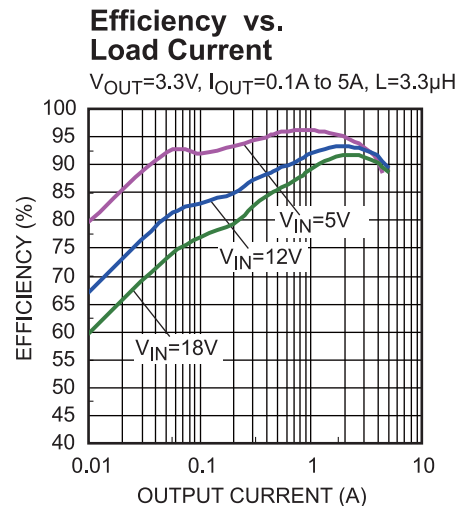

EVALUATION BOARD SCHEMATIC

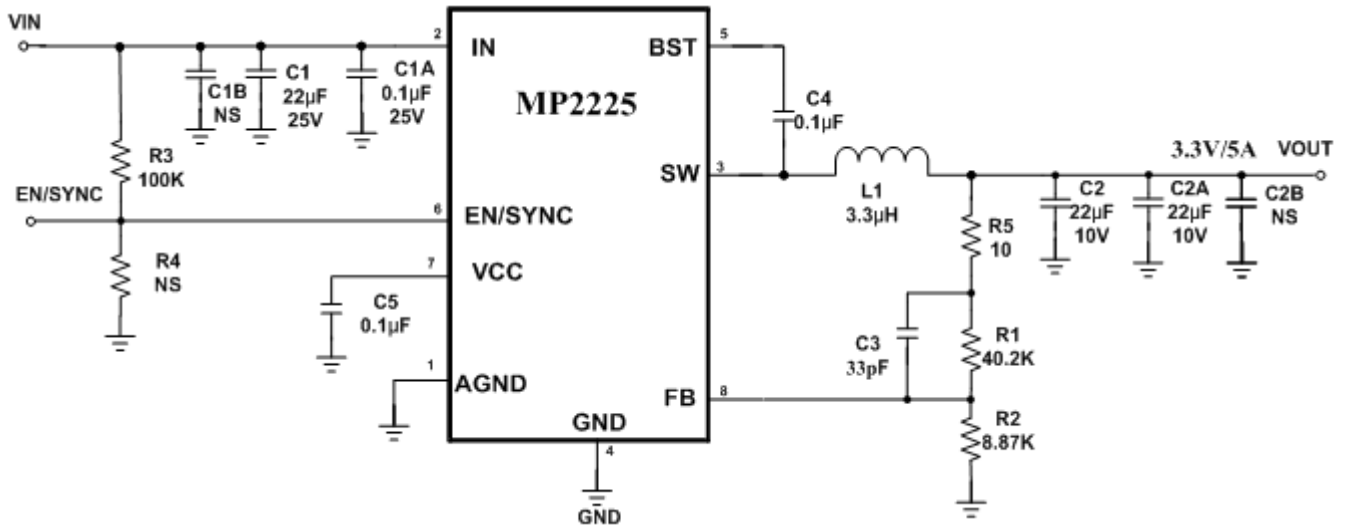

EV2225-J-00A BILL OF MATERIALS

Qty	RefDes	Value	Description	Package	Manufacturer	Manufacturer P/N
1	C1A	0.1uF	Ceramic Cap., 25V, X7R	0603	muRata	GRM188R71E104KA01D
1	C1	22uF	Ceramic Cap., 25V, X5R	1206	muRata	GRM31CR61E226KE15L
2	C1B, C2B	NS				
2	C2, C2A	22uF	Ceramic Cap., 10V, X7R	1206	muRata	GRM21BR60J226ME39L
1	C3	33pF	Ceramic Cap., 50V, C0G	0603	muRata	GRM1885C1H330JA01D
2	C4, C5	0.1uF	Ceramic Cap., 16V, X7R	0603	muRata	GRM188R71C104KA01D
1	R1	40.2K	Thick Film Res., 1%	0603	Yageo	RL0603FR-0740K2L
1	R2	8.87K	Thick Film Res., 1%	0603	Yageo	RL0603FR-078K87L
1	R3	100K	Thick Film Res., 1%	0603	Yageo	RL0603FR-07100KL
1	R4	NS				
1	R5	10Ω	Thick Film Res., 1%	0603	Yageo	RL0603FR-0710RL
1	L1	3.3uH	Inductor, DCR=9mΩ, Is=8A	SMD	Würth	744 314 330
1	U1	MP2225-J	Synchronous Step-Down Convert	TSOT23-8	MPS	MP2225-J

PRINTED CIRCUIT BOARD LAYOUT

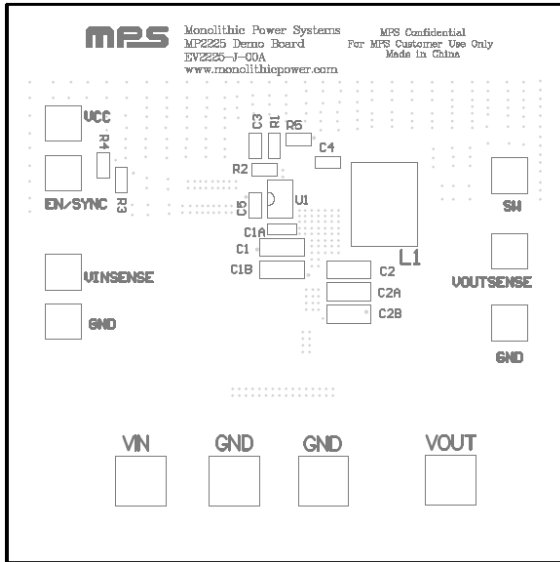

Figure 1—Top Silk Layer

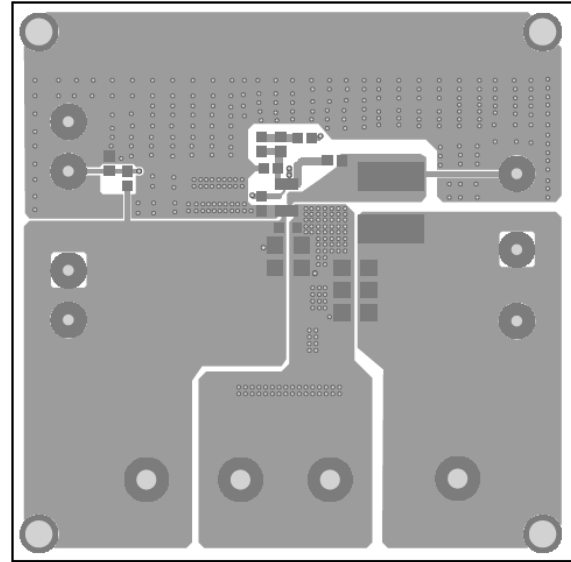

Figure 2—Top Layer

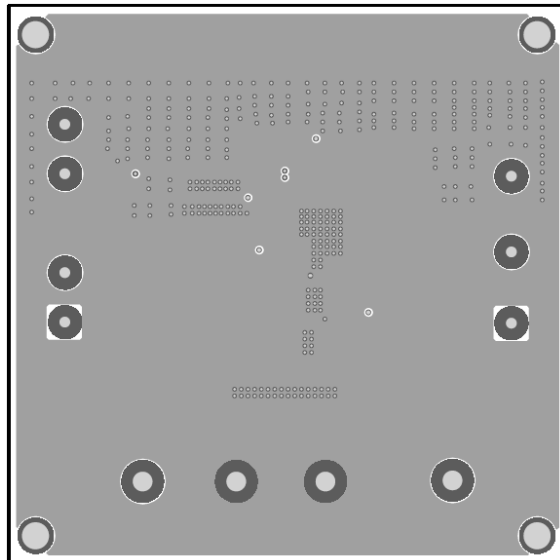

Figure 3—Inner Layer 1

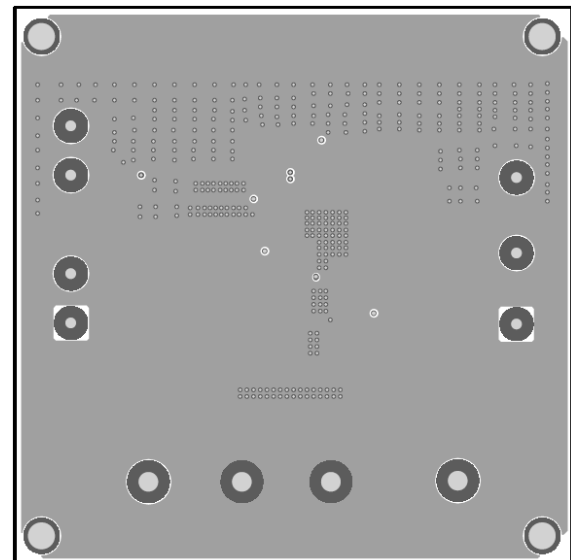

Figure 4—Inner Layer 2

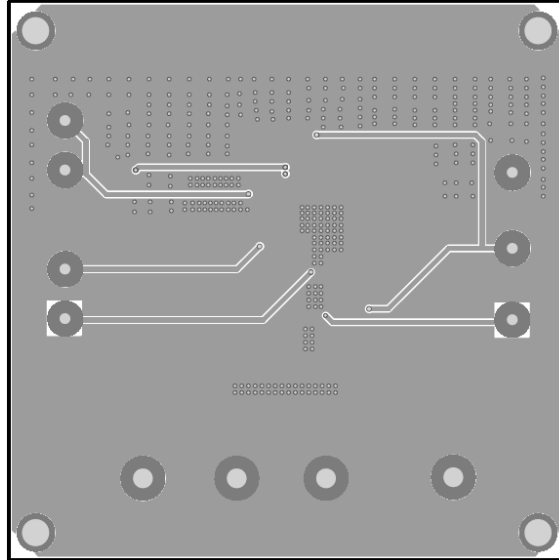

Figure 5—Bottom Layer

QUICK START GUIDE

1. Connect the positive and negative terminals of the load to the VOUT and GND pins, respectively.
2. Preset the power supply output between 4.5V and 18V, and then turn off the power supply.
3. Connect the positive and negative terminals of the power supply output to the VIN and GND pins, respectively.
4. Turn the power supply on. The board will automatically start up.

NOTICE: The information in this document is subject to change without notice. Please contact MPS for current specifications. Users should warrant and guarantee that third party Intellectual Property rights are not infringed upon when integrating MPS products into any application. MPS will not assume any legal responsibility for any said applications.