



EV2238-D-00A

High-Efficiency, 8A, 18V. Step-Down Converter Evaluation Board

DESCRIPTION

The EV2238-D-00A Evaluation Board is designed to demonstrate the capabilities of MPS' MP2238, a fully-integrated high-frequency, synchronous rectified, step-down, switch-mode converter with internal power MOSFETs. It offers a very compact solution to achieve an 8A continuous output current over a wide input range, with excellent load and line regulation.

Constant On-Time control operation provides very fast transient response and easy loop design as well as very tight output regulation.

Full protection features include SCP, OCP, and thermal shutdown.

The MP2238 requires a minimal number of readily-available, standard, external components and is available in a space-saving 12-pin QFN 2mmx3mm package.

ELECTRICAL SPECIFICATION (1)

Parameter	Symbol	Value	Units
Input Voltage	V_{IN}	12	V
Output Voltage	V_{OUT}	1	V
Output Current	I_{OUT}	8	A

Notes:

1) For different Input/output voltage specs and different output capacitor/inductor may need change the application circuit parameters.

FEATURES

- Wide 4.2V-to-18V Operating Input Range
- 22mΩ/10mΩ Low- $R_{DS(ON)}$ Internal Power MOSFETs
- 8A Continuous Output Current
- 600mV Reference Voltage
- 600kHz Switching Frequency
- Internal Soft-Start
- Over-Current Protection and Hiccup
- Thermal Shutdown
- Ton Extension
- Available in a 12-pin QFN 2mx3mm package

APPLICATIONS

- Digital TV Power Supply
- Digital Set-Top Boxes
- Flat-Panel Television and Monitors
- Distributed Power Systems

All MPS parts are lead-free, halogen free, and adhere to the RoHS directive. For MPS green status, please visit MPS website under Quality Assurance. "MPS" and "The Future of Analog IC Technology" are Registered Trademarks of Monolithic Power Systems, Inc.

EV2238-D-00A EVALUATION BOARD

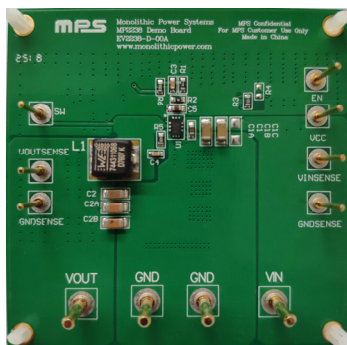

(L x W) 63.5mm x 63.5mm

Board Number	MPS IC Number
EV2238-D-00A	MP2238GD

Efficiency

$V_{OUT}=1V$, $L=0.68\mu H$, $DCR=3.1m\Omega$

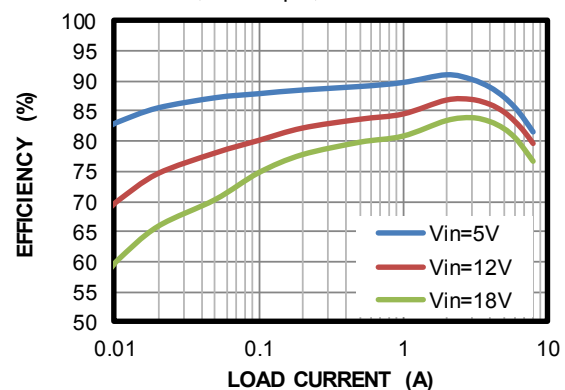

EVALUATION BOARD SCHEMATIC

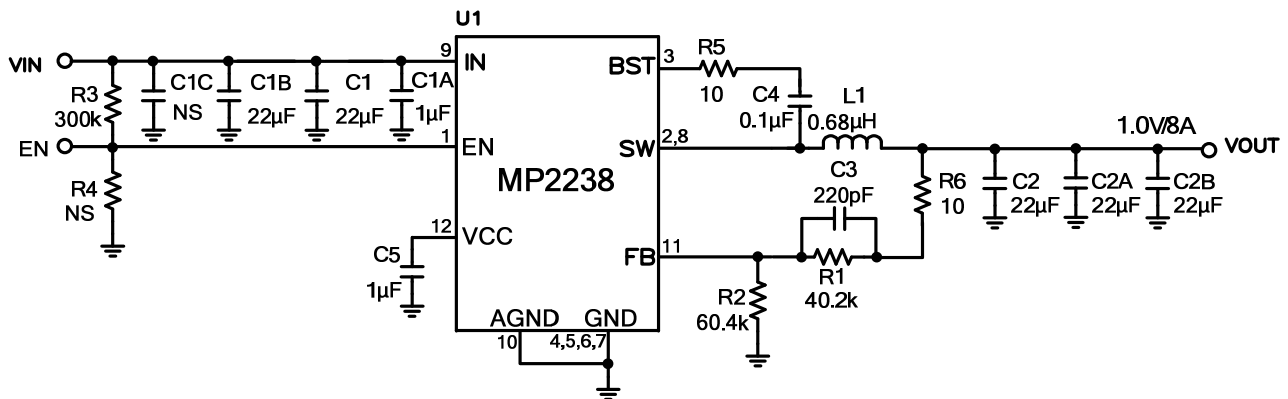

EV2238-D-00A BILL OF MATERIALS

Qty	Ref	Value	Description	Package	Manufacturer	Part Number
2	C1, C1B	22µF	Ceramic Cap.,.25V,X5R	1206	Murata	GRM31CR61E226KE15L
2	C1A, C5	1µF	Ceramic Cap.,.25V,X7R	0603	Murata	GRM188R71E105KA12D
0	C1C	NS				
3	C2, C2A, C2B	22µF	Ceramic Cap.,10V,X7R	1206	Murata	GRM31CR71A226ME15L
1	C3	220pF	Ceramic Cap.,50V,X7R	0603	Murata	GRM188R71H221KA01D
1	C4	100nF	Ceramic Cap.,16V,X7R	0603	Murata	GRM188R71C104KA01D
1	R1	40.2k	Film Res,1%,0603	0603	YAGEO	RC0603FR-0740K2L
1	R2	60.4k	Film Res,1%,0603	0603	YAGEO	RC0603FR-0760K4L
1	R3	300k	Film Res,1%,0603	0603	YAGEO	RC0603FR-07300KL
0	R4	NS				
2	R5, R6	10R	Film Res,1%,0603,10R	0603	YAGEO	RC0603FR-0710RL
1	L1	0.68µH	Inductor, R _{DC} =3.1mΩ, I _{sat} =20A	SMD	Würth	744311068
1	U1	MP2238GD	Step-down converter	QFN	MPS	MP2238GD

EVB TEST RESULTS

$V_{IN} = 12V$, $V_{OUT} = 1V$, $L = 0.68\mu H$, $T_A = +25^\circ C$, unless otherwise noted.

Input / Output Ripple

$I_{OUT} = 0A$

CH1: V_{out}/AC
20mV/div.
CH2: V_{in}/AC
50mV/div.
CH3: V_{sw}
10V/div.
CH4: I_L
2A/div.

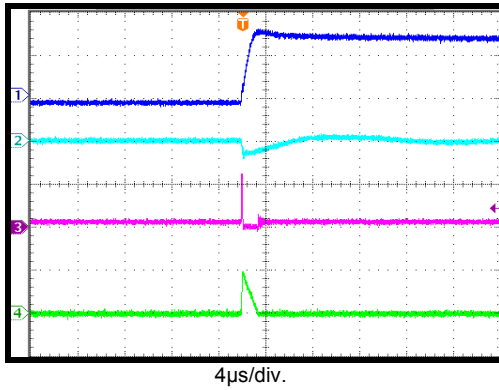

Input / Output Ripple

$I_{OUT} = 8A$

CH1: V_{out}/AC
20mV/div.
CH2: V_{in}/AC
100mV/div.
CH3: V_{sw}
10V/div.
CH4: I_L
5A/div.

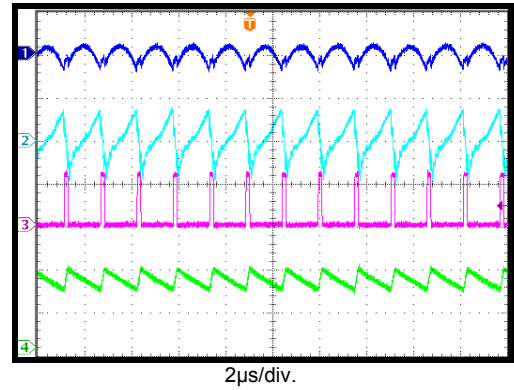

Start up through Input Voltage

$I_{OUT} = 0A$

CH1: V_{out}
1V/div.
CH2: V_{in}
10V/div.
CH3: V_{sw}
5V/div.
CH4: I_L
2A/div.

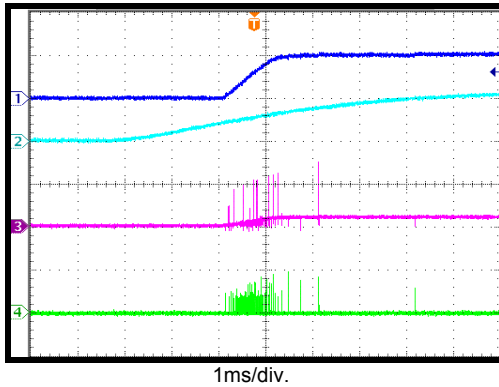

Start up through Input Voltage

$I_{OUT} = 8A$

CH1: V_{out}
1V/div.
CH2: V_{in}
10V/div.
CH3: V_{sw}
5V/div.
CH4: I_L
5A/div.

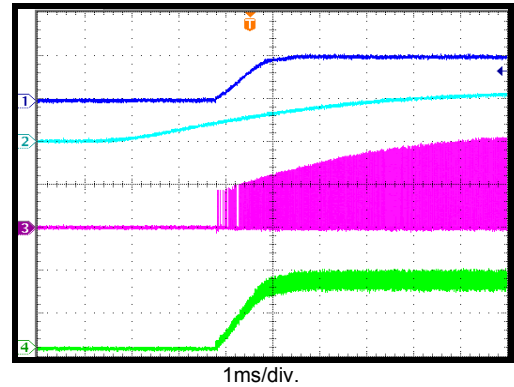

Shutdown through Input Voltage

$I_{OUT} = 0A$

CH1: V_{out}
1V/div.
CH2: V_{in}
10V/div.
CH3: V_{sw}
5V/div.
CH4: I_L
2A/div.

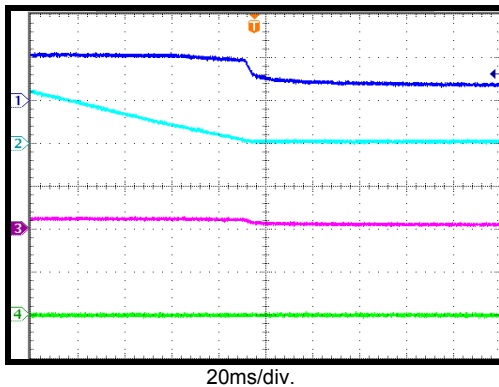

Shutdown through Input Voltage

$I_{OUT} = 8A$

CH1: V_{out}
1V/div.
CH2: V_{in}
10V/div.
CH3: V_{sw}
5V/div.
CH4: I_L
5A/div.

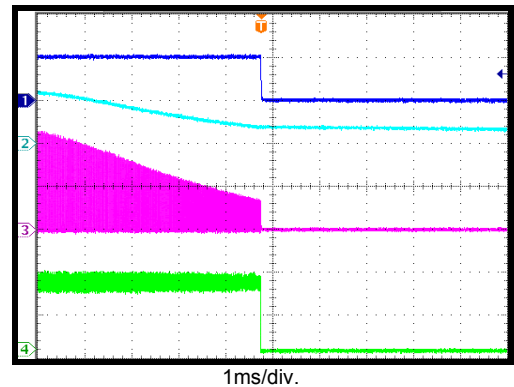

EVB TEST RESULTS (continued)
 $V_{IN} = 12V$, $V_{OUT} = 1V$, $L = 0.68 \mu H$, $T_A = 25^\circ C$, unless otherwise noted.

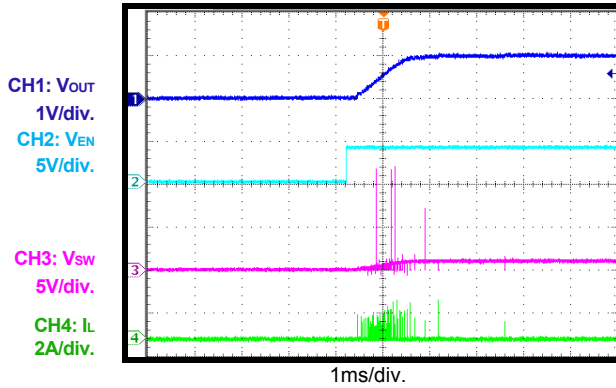
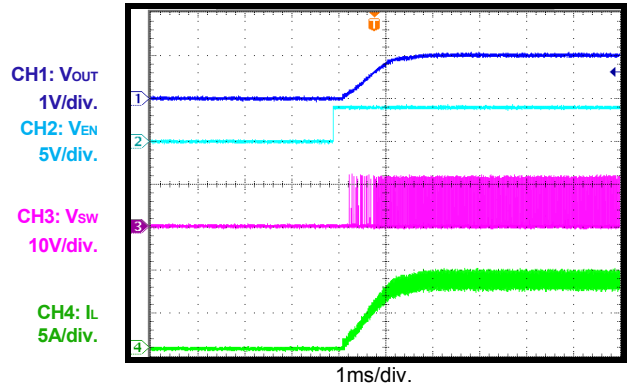
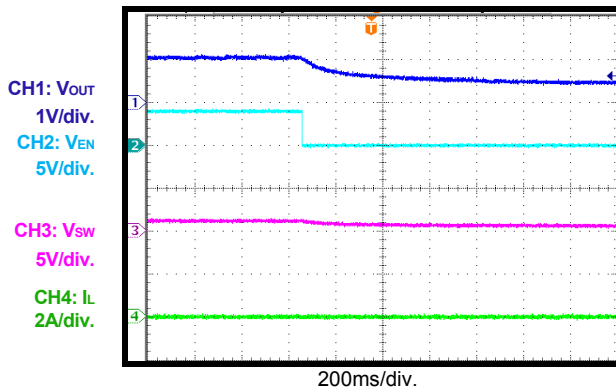
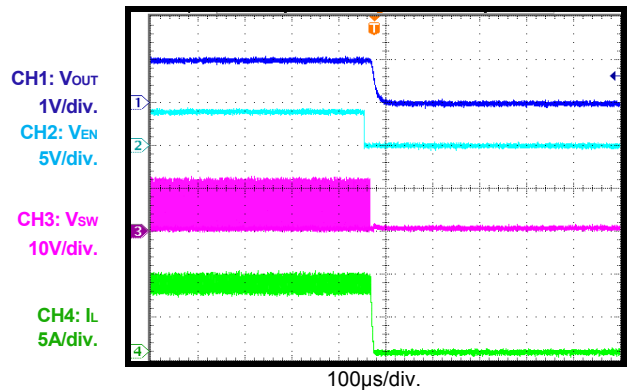
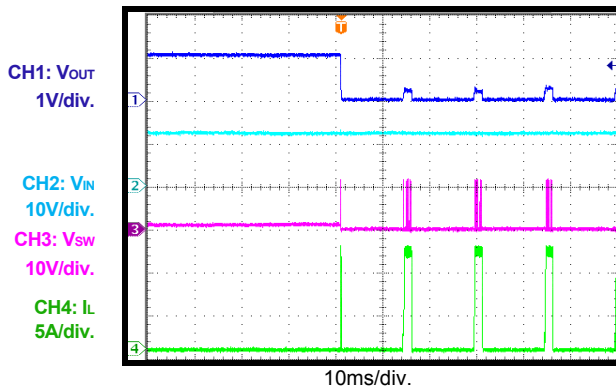
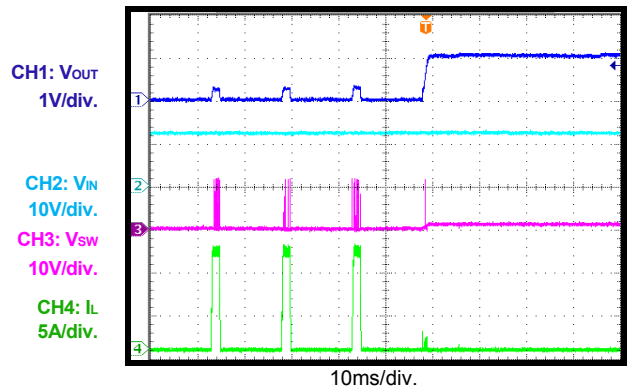
Start up through Enable
 $I_{OUT} = 0A$

Start up through Enable
 $I_{OUT} = 8A$

Shutdown through Enable
 $I_{OUT} = 0A$

Shutdown through Enable
 $I_{OUT} = 8A$

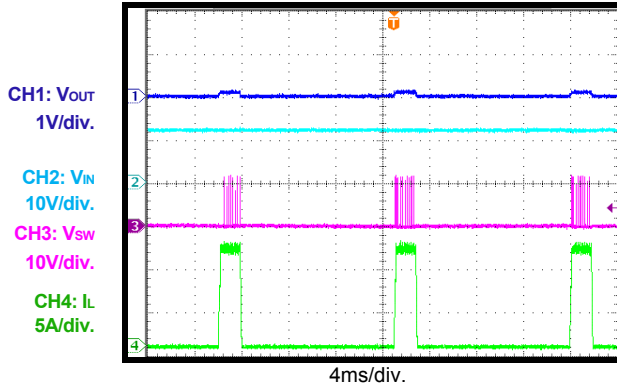
Short Circuit Entry

Short Circuit Recovery

EVB TEST RESULTS (continued)

$V_{IN} = 12V$, $V_{OUT} = 1V$, $L=0.68 \mu H$, $T_A = 25^\circ C$, unless otherwise noted.

Short Circuit Steady



Transient Response

$I_{OUT}=4A$ to $8A$

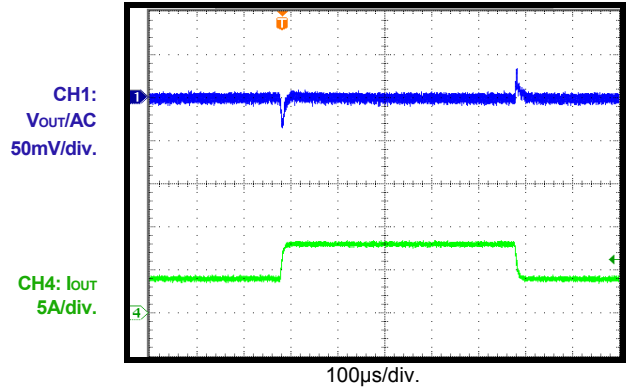

PRINTED CIRCUIT BOARD LAYOUT

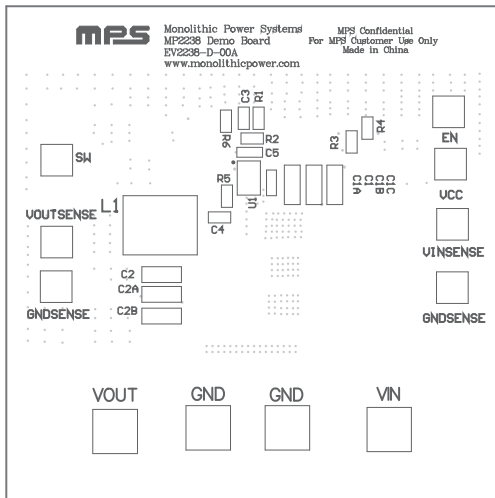

Figure 1—Top Silk Layer

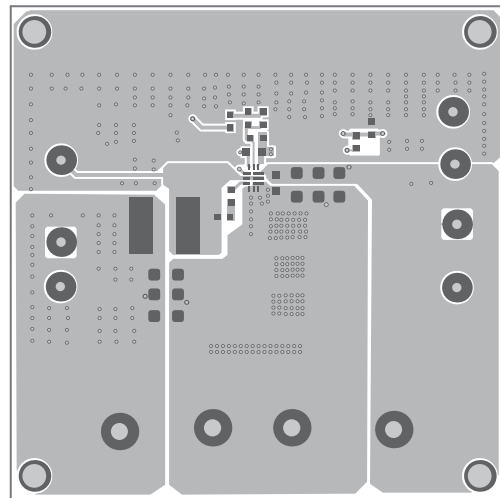

Figure 2—Top Layer

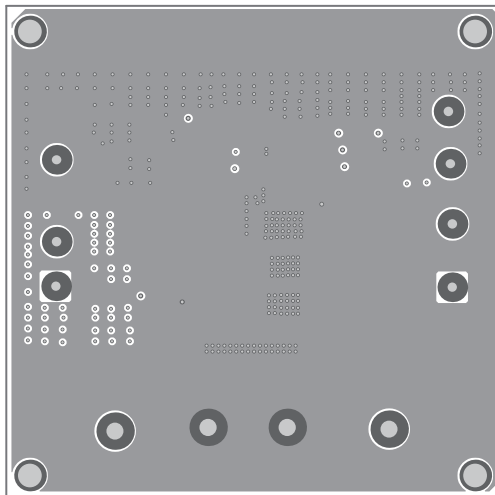

Figure 3—IN1 Layer

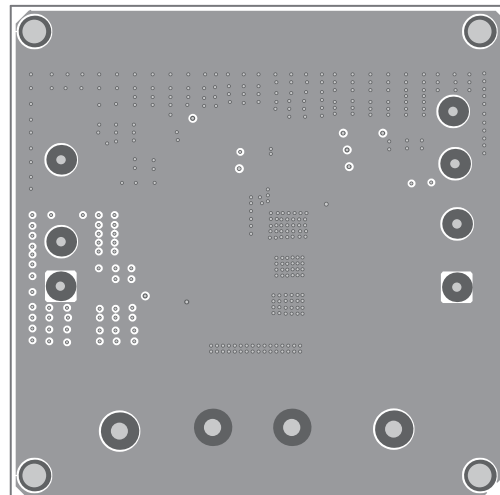

Figure 4—IN2 Layer

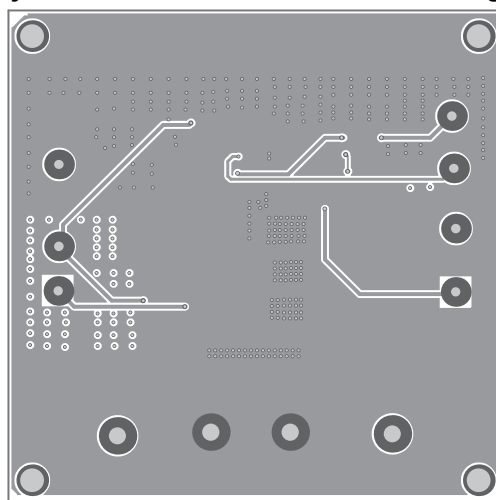

Figure 5—Bottom Layer

QUICK START GUIDE

1. Preset Power Supply to 12V.
2. Turn Power Supply off.
3. Connect Power Supply terminals to:
 - a. Positive (+): VIN
 - b. Negative (-): GND
4. Connect Load to:
 - a. Positive (+): VOUT
 - b. Negative (-): GND
5. Turn Power Supply on after making connections. The board will automatically start up.
6. To use the Enable function, apply a digital input to the EN pin. Drive EN higher than 1.3V to turn on the regulator, or less than 0.9V to turn it off.

NOTICE: The information in this document is subject to change without notice. Please contact MPS for current specifications. Users should warrant and guarantee that third party Intellectual Property rights are not infringed upon when integrating MPS products into any application. MPS will not assume any legal responsibility for any said applications.