

DESCRIPTION

The EV2315S-J-00A demonstrates MPS's MP2315S, a high-frequency, synchronous, rectified, step-down converter with built-in high-side and low-side power MOSFETs. The MP2315S offers a very compact solution to achieve a 3A continuous output current with excellent load and line regulation over a wide input supply range. The MP2315S has synchronous mode operation for higher efficiency over the output current load range.

Current-mode operation provides fast transient response and eases loop stabilization.

Full protection features includes over-current protection and thermal shutdown.

The MP2315S is available in a space-saving 8-pin TSOT23 package.

ELECTRICAL SPECIFICATION

Parameter	Symbol	Value	Units
Input Voltage	V_{IN}	4.5 – 24	V
Output Voltage	V_{OUT}	5	V
Output Current	I_{OUT}	3	A

FEATURES

- Wide 4.5V to 24V Operating Input Range
- 110mΩ/55mΩ Low $R_{DS(ON)}$ Internal Power MOSFET
- Low Quiescent Current
- High-Efficiency Synchronous Mode Operation
- Fixed 500kHz Switching Frequency
- AAM Power-Save Mode
- Internal Soft-Start
- Output Over Voltage Protection
- OCP Protection and Hiccup
- Thermal Shutdown
- Output Adjustable from 0.8V
- Available in an 8-pin TSOT-23 Package

APPLICATIONS

- Notebook System and I/O Power
- Digital Set-Top Boxes
- Flat-Panel Television and Monitors

All MPS parts are lead-free and adhere to the RoHS directive. For MPS green status, please visit MPS website under Products, Quality Assurance page. "MPS" and "The Future of Analog IC Technology" are registered trademarks of Monolithic Power Systems, Inc.

EV2315S-J-00A EVALUATION BOARD



Board Number	MPS IC Number
EV2315S-J-00A	MP2315SGJ

Efficiency vs. Output Current

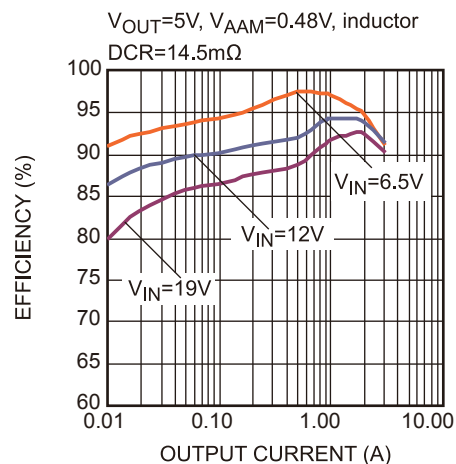

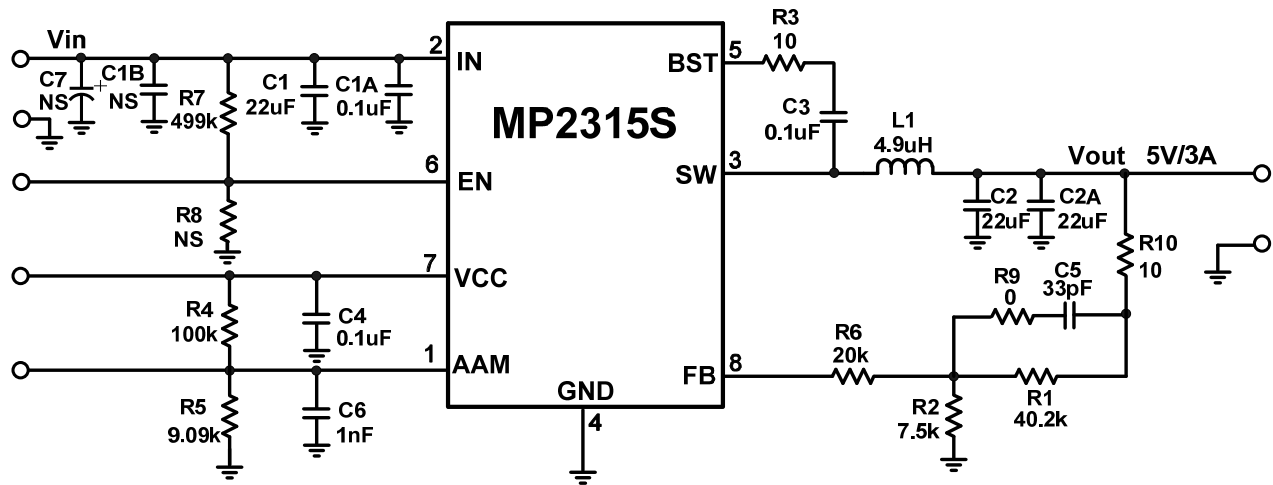
EVALUATION BOARD SCHEMATIC

EV2315S-J-00A BILL OF MATERIALS

Qty	Ref	Value	Description	Package	Manufacturer	Manufacturer P/N
1	C1	22 μ F	Ceramic Cap., 25V, X5R	1206	muRata	GRM31CR61E226KE15L
1	C1A	0.1 μ F	Ceramic Cap., 25V, X5R	0805	muRata	GRM21BR71E104KA01L
0	C1B, C7	NS				
2	C2, C2A	22 μ F	Ceramic Cap., 16V, X5R	1206	muRata	GRM31CR61C226ME15L
2	C3, C4	0.1 μ F	Ceramic Cap., 16V, X5R	0603	muRata	GRM188R71C104KA01D
1	C5	33pF	Ceramic Cap., 50V, C0G	0603	muRata	GRM1885C1H330JA01D
1	C6	1nF	Ceramic Cap., 50V, X7R	0603	muRata	GRM188R71H102KA01D
1	R1	40.2k	Thick Film Res., 1%	0603	Yageo	RL0603FR-0740K2L
1	R2	7.5k	Thick Film Res., 1%	0603	Yageo	RL0603FR-077K5L
2	R3, R10	10 Ω	Thick Film Res., 1%	0603	Yageo	RL0603FR-0710RL
1	R4	100k	Thick Film Res., 1%	0603	Yageo	RL0603FR-07100KL
1	R5	9.09k	Thick Film Res., 1%	0603	Yageo	RL0603FR-079K09L
1	R6	20k	Thick Film Res., 1%	0603	Yageo	RL0603FR-0720KL
1	R7	499k	Thick Film Res., 1%	0603	Yageo	RL0603FR-07499KL
0	R8	NS				
1	R9	0	Thick Film Res., 1%	0603	Yageo	RC0603FR-070RL
1	L1	4.9 μ H	DCR=14.5m Ω , Isat=6.5A	7.0x6.9x5.0	Würth	744314490
1	U1	MP2315S	Synchronous Step-Down Convert	TSOT23-8	MPS	MP2315SGJ

EVB TEST RESULTS

Performance waveforms are tested on the evaluation board.

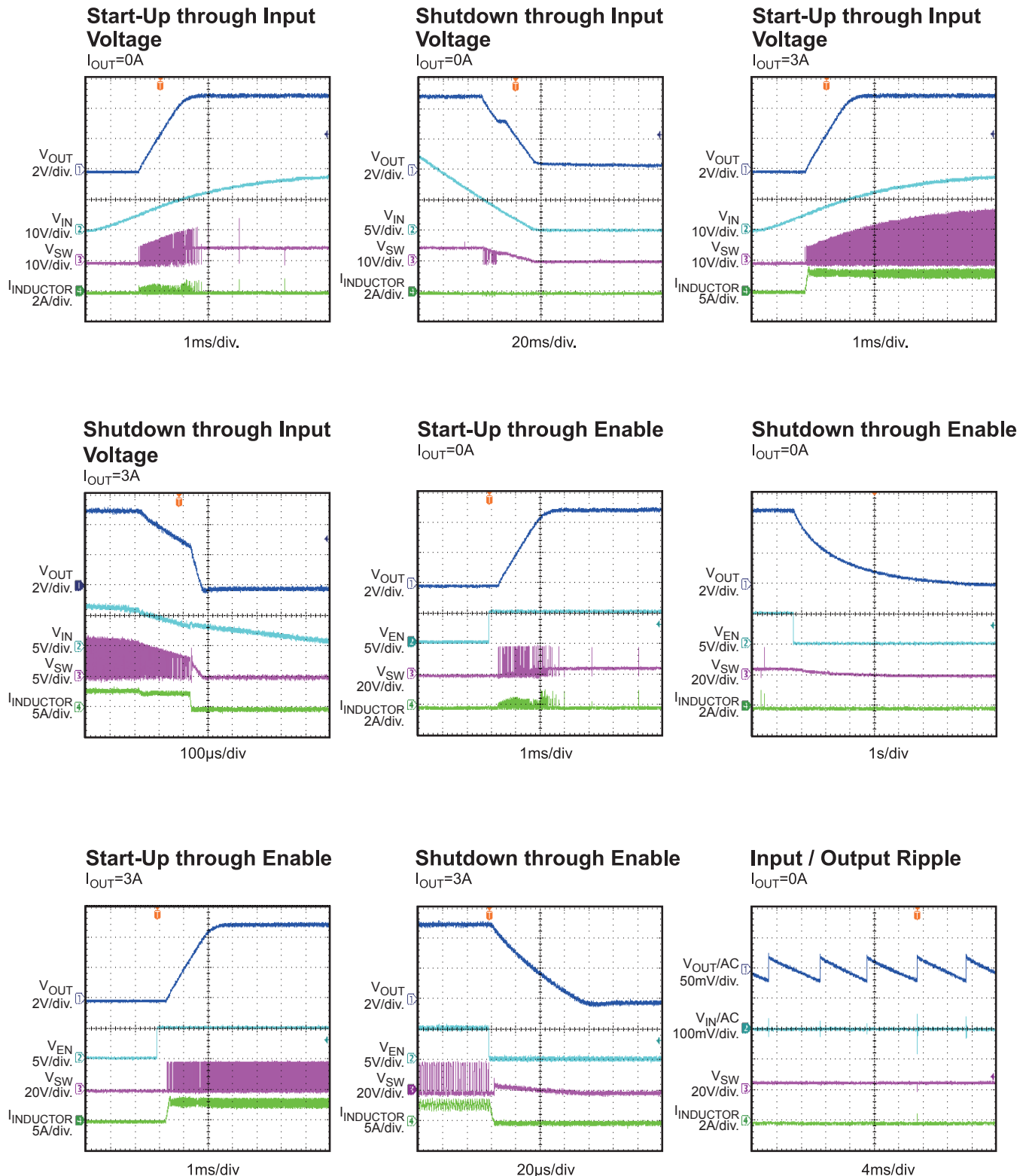
$V_{IN} = 12V$, $V_{OUT} = 5V$, $L = 4.9\mu H$, $T_A = 25^\circ C$, unless otherwise noted.



EVB TEST RESULTS *(continued)*

Performance waveforms are tested on the evaluation board.

$V_{IN} = 12V$, $V_{OUT} = 5V$, $L = 4.9\mu H$, $T_A = 25^\circ C$, unless otherwise noted.

Input / Output Ripple

$I_{OUT} = 3A$

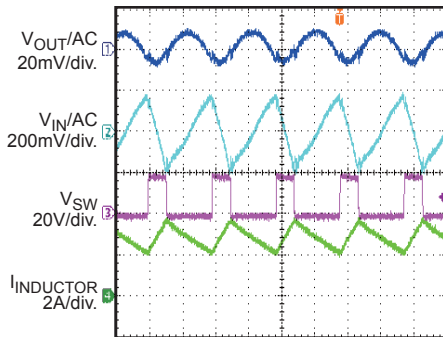

1μs/div.

Transient Response

$I_{OUT} = 1.5A-3A, 2.5A/\mu s$

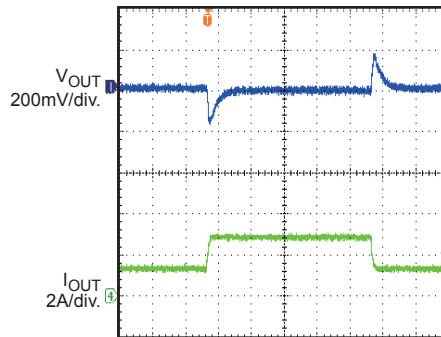

100μs/div.

Short Circuit Entry

$I_{OUT} = 0A$

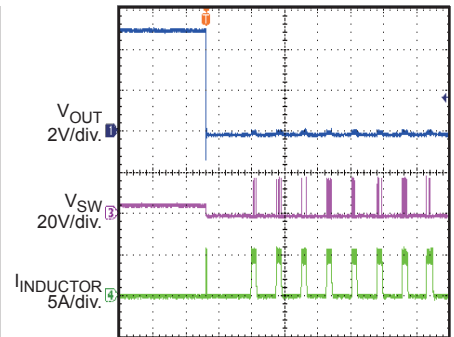

10ms/div.

Short Circuit Recovery

$I_{OUT} = 0A$

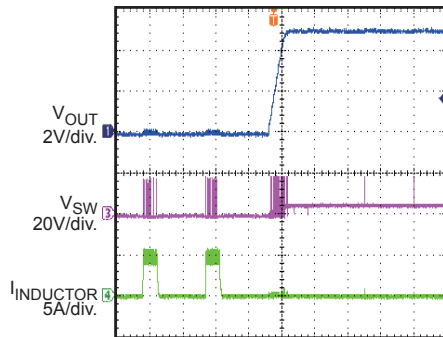

4ms/div

Bode Plot

$I_{OUT} = 3A$

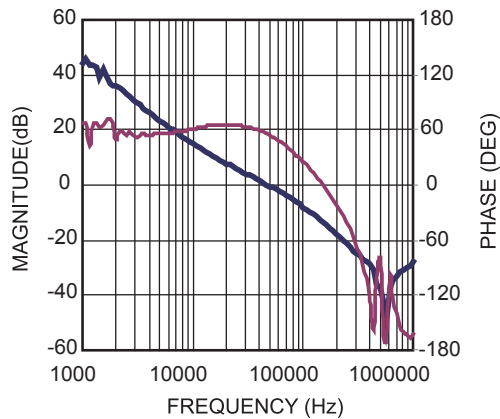

PRINTED CIRCUIT BOARD LAYOUT

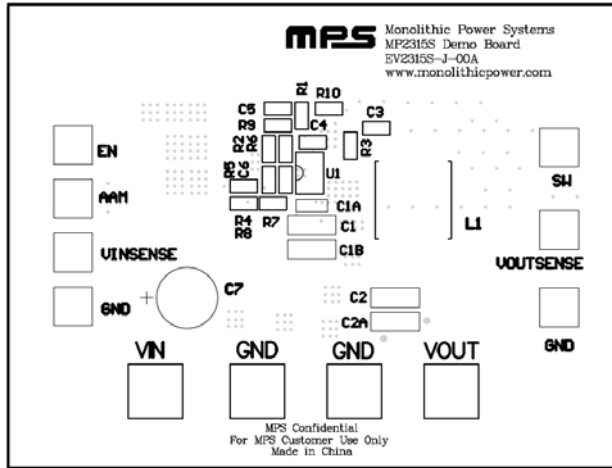

Figure 1—Top Silk Layer

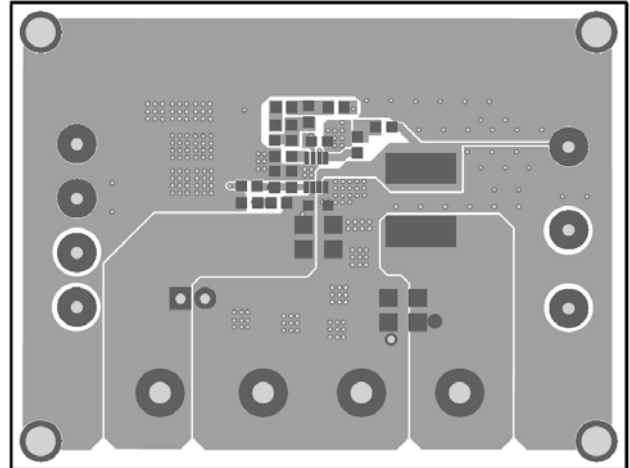

Figure 2—Top Layer

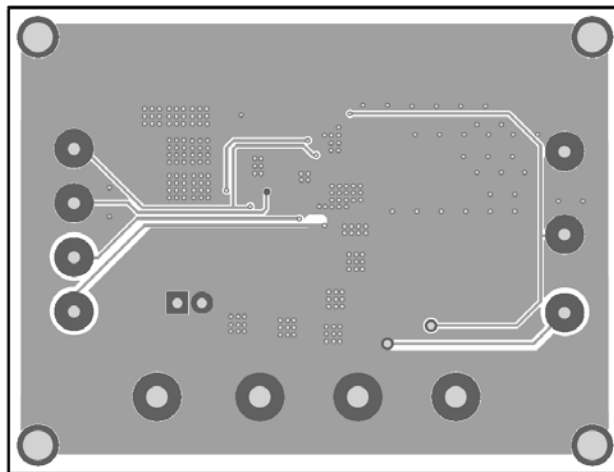

Figure 3—Bottom Layer

QUICK START GUIDE

1. Connect the positive and negative terminals of the load to the VOUT and GND pins, respectively.
2. Preset the power supply output between 4.5V and 24V, and then turn off the power supply.
3. Connect the positive and negative terminals of the power supply output to the VIN and GND pins, respectively.
4. Turn the power supply on. The board will automatically start up.
5. To use the Enable function, apply a digital input to the EN/SYNC pin. Drive EN higher than 1.4V to turn on the regulator, or less than 1.25V to turn it off.

NOTICE: The information in this document is subject to change without notice. Please contact MPS for current specifications. Users should warrant and guarantee that third party Intellectual Property rights are not infringed upon when integrating MPS products into any application. MPS will not assume any legal responsibility for any said applications.