

DESCRIPTION

The MP2344 is a high frequency synchronous rectified step-down switch mode converter with built in internal power MOSFETs. It offers a very compact solution to achieve 2A continuous output current over a wide input supply range with excellent load and line regulation.

The Evaluation Board can deliver a 2A continuous output current with excellent load and line regulation over a wide input supply range.

Full protection features include over-current protection and thermal shut down.

The MP2344 requires a minimum number of readily-available standard external components and is available in a space saving 6-pin TSOT23 package.

ELECTRICAL SPECIFICATION

Parameter	Symbol	Value	Units
Input Voltage	V _{IN}	7.5 – 26	V
Output Voltage	V _{OUT}	5	V
Output Current	I _{OUT}	2	A

FEATURES

- Wide 7.5V to 26V Operating Input Range
- 2A Load Current
- 95mΩ/45mΩ Low R_{ds(on)} Internal Power MOSFETs
- Power Save Mode for Light Load Condition
- 600kHz Fixed Switching Frequency at CCM
- Switching Node Ringing Reduction
- Internal Soft Start
- OCP Protection and Hiccup
- Thermal Shutdown
- Output Adjustable from 3.3V
- Available in a 6-pin TSOT23 package

APPLICATIONS

- Standby Power Supply
- White Goods
- Flat Panel Television and Monitors

All MPS parts are lead-free, halogen free, and adhere to the RoHS directive. For MPS green status, please visit MPS website under Quality Assurance. "MPS" and "The Future of Analog IC Technology" are Registered Trademarks of Monolithic Power Systems, Inc.

EV2344-J-00A EVALUATION BOARD



Board Number	MPS IC Number
EV2344-J-00A	MP2344GJ

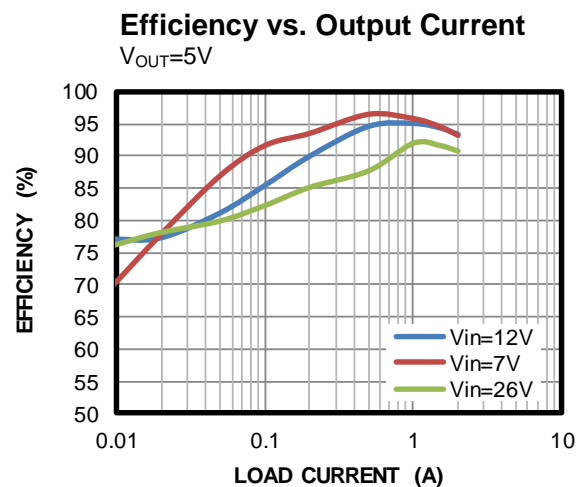

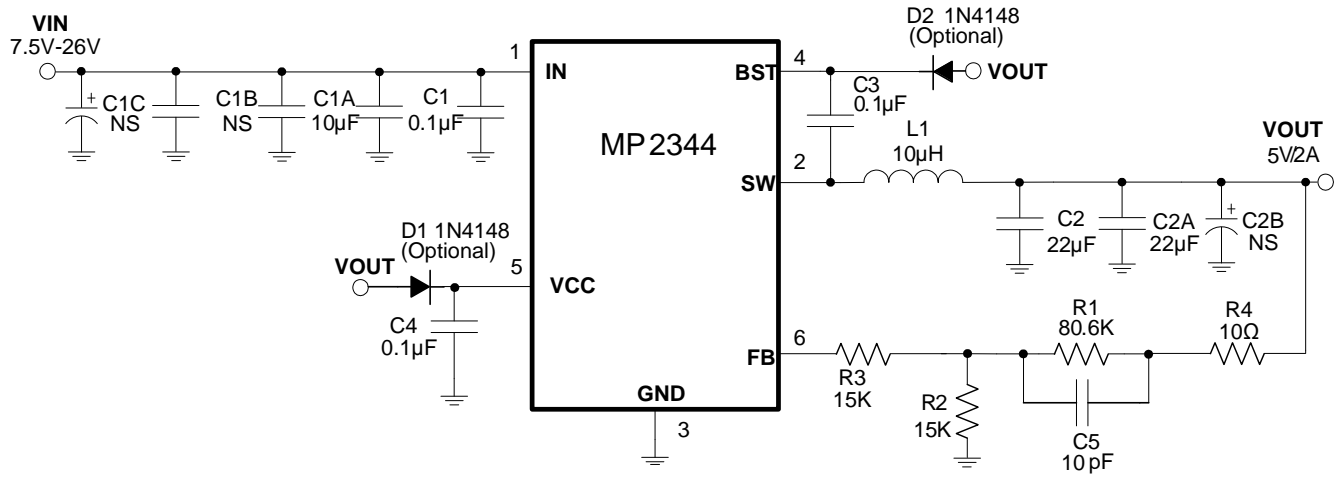
EVALUATION BOARD SCHEMATIC

EV2344-J-00A BILL OF MATERIALS

Qty	Ref	Value	Description	Package	Manufacturer	Manufacturer P/N
1	C1	0.1µF	Ceramic Cap,50V,X7R	0603	Murata	GRM188R71H104KA93D
2	C3, C4	0.1µF	Ceramic Cap,25V,X7R	0603	Murata	GRM188R71E104KA01D
1	C1A	10µF	Ceramic Cap,50V,X5R	1206	Murata	GRM31CR61H106KA12L
2	C2, C2A	22µF	Ceramic Cap, 25V, X5R	1206	Murata	GRM31CR61E226KE15L
0	C1C, C2B, C1B	NS				
1	C5	10pF	Ceramic Cap,50V,C0G	0603	Murata	GRM1885C1H100JA01D
0	D1, D2	NS				
1	R1	80.6kΩ	Film Res., 1%	0603	Yageo	RC0603FR-0780K6L
2	R2, R3	15kΩ	Film Res., 1%	0603	Yageo	RC0603FR-0715KL
1	R4	10 Ω	Film Res., 1%	0603	Yageo	RC0603JR-0710RL
1	L1	10µH	DCR=35mΩ, Isat=4A	SMD	Würth	744 066 100
1	U1	MP2344	Step-Down Converter	TSOT23-6	MPS	MP2344GJ

EVB TEST RESULTS

$V_{IN} = 12V$, $V_{OUT} = 5V$, $L = 10\mu H$, $DCR=35m\Omega$, $T_A = 25^\circ C$, unless otherwise noted.

Efficiency vs. Output Current

$V_{OUT}=5V$

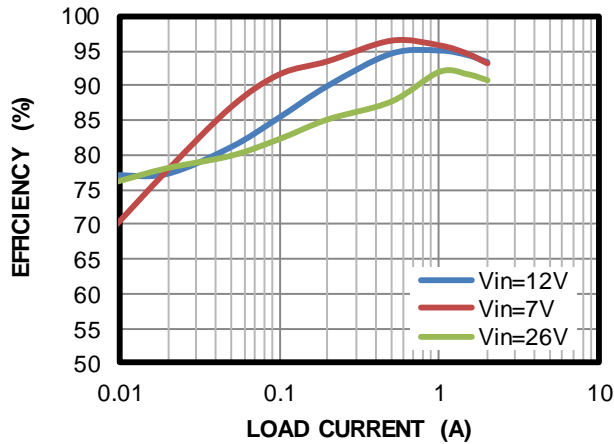

Efficiency vs. Output Current

$V_{OUT}=3.3V$

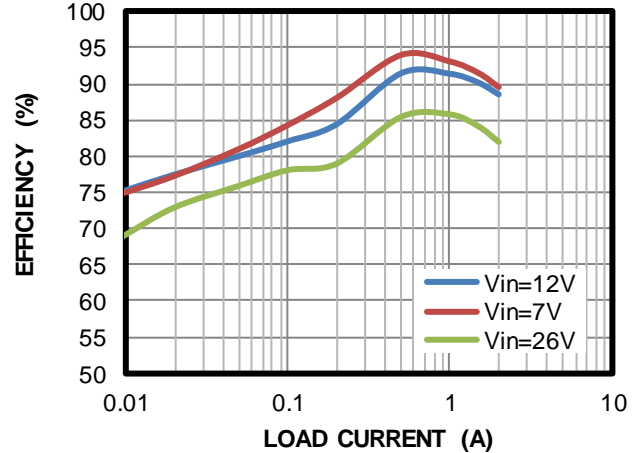

Load Regulation

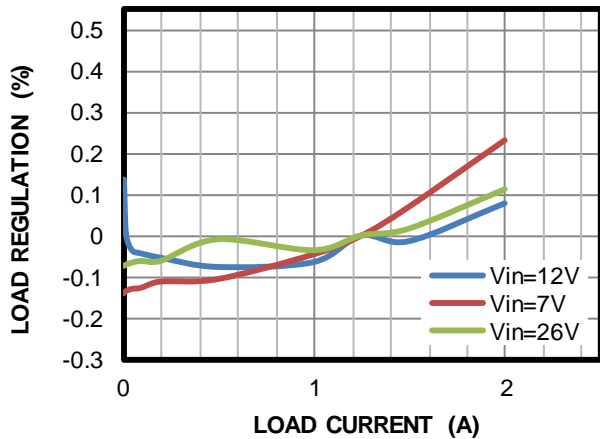

Line Regulation

$I_{OUT}=0.1A$

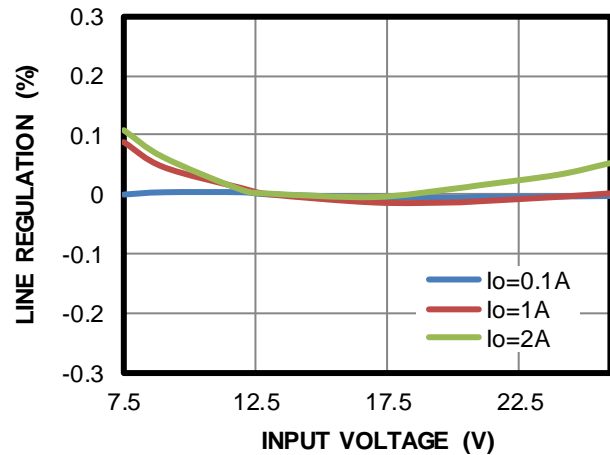

Case Temperature

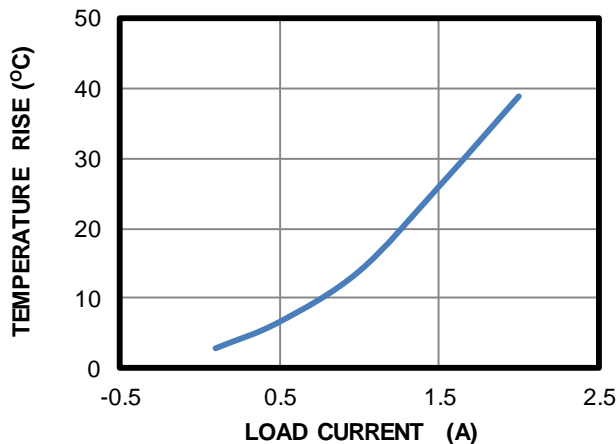

Enable Supply Current vs. Input Voltage

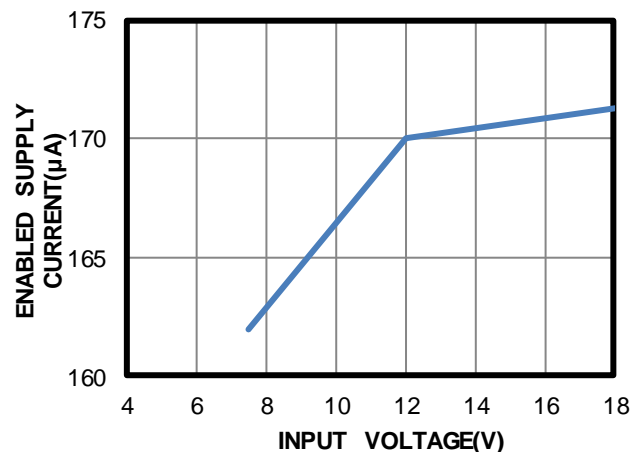

EVB TEST RESULTS (continued)
 $V_{IN} = 12V$, $V_{OUT} = 5V$, $L = 10\mu H$, $DCR=35m\Omega$, $T_A = 25^\circ C$, unless otherwise noted.

Input/Output Ripple
 $I_{OUT}=0A$

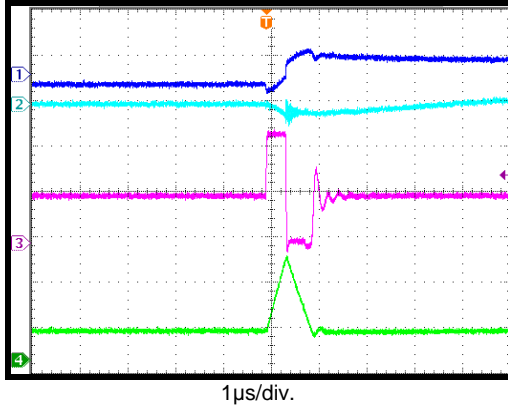
 CH1: V_{OUT}/AC
 10mV/div.
 CH2: V_{IN}
 50mV/div.
 CH3: V_{SW}
 5V/div.
 CH4: I_{OUT}
 200mA/div.

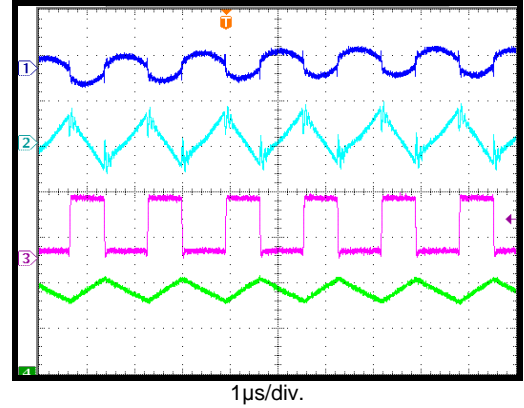
Input/Output Ripple
 $I_{OUT}=2A$

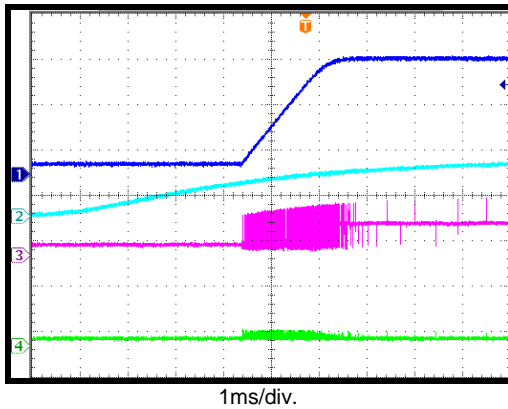
 CH1: V_{OUT}/AC
 10mV/div.
 CH2: V_{IN}
 10mV/div.
 CH3: V_{SW}
 10V/div.
 CH4: I_{OUT}
 1A/div.

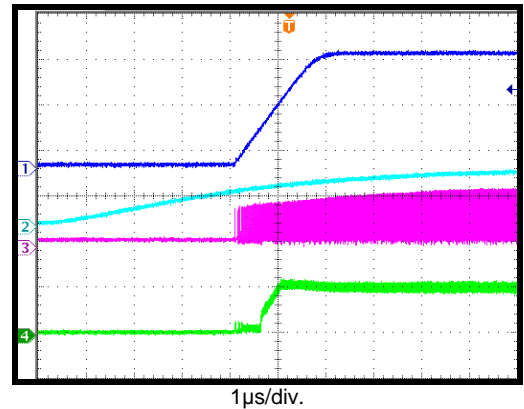
Start-Up through Input Voltage
 $I_{OUT}=0A$

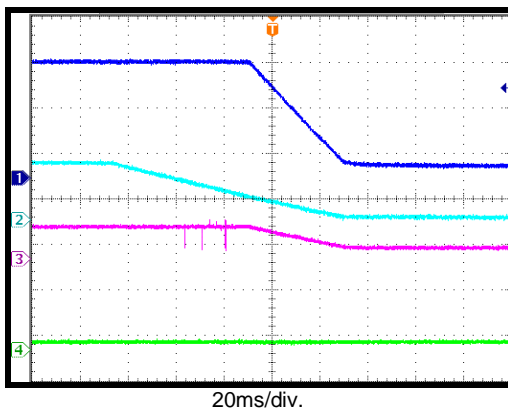
 CH1: V_{OUT}
 2V/div.
 CH2: V_{IN}
 10V/div.
 CH3: V_{SW}
 10V/div.
 CH4: I_L
 2A/div.

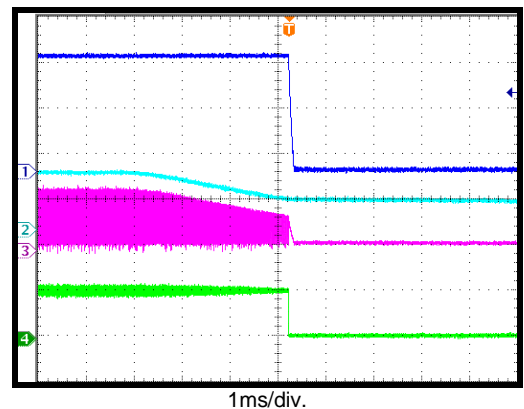
Start-Up through Input Voltage
 $I_{OUT}=2A$

 CH1: V_{OUT}
 2V/div.
 CH2: V_{IN}
 10V/div.
 CH3: V_{SW}
 10V/div.
 CH4: I_L
 2A/div.

Shutdown through Input Voltage
 $I_{OUT}=0A$

 CH1: V_{OUT}
 2V/div.
 CH2: V_{IN}
 10V/div.
 CH3: V_{SW}
 10V/div.
 CH4: I_L
 2A/div.

Shutdown through Input Voltage
 $I_{OUT}=2A$

 CH1: V_{OUT}
 2V/div.
 CH2: V_{IN}
 10V/div.
 CH3: V_{SW}
 10V/div.
 CH4: I_L
 2A/div.

EVB TEST RESULTS *(continued)*

$V_{IN} = 12V$, $V_{OUT} = 5V$, $L = 10\mu H$, $DCR=35m\Omega$, $T_A = 25^\circ C$, unless otherwise noted.

OCP Entry

$I_{OUT}=0A$

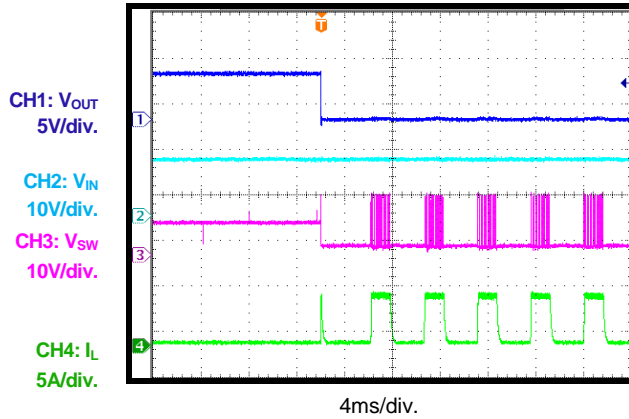

OCP Recovery

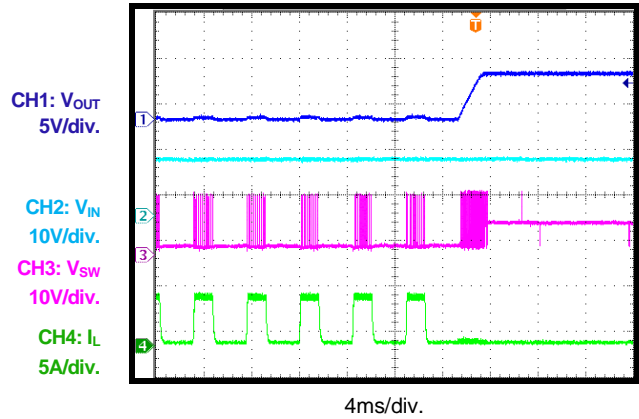

Load Transient Response

1A-2A

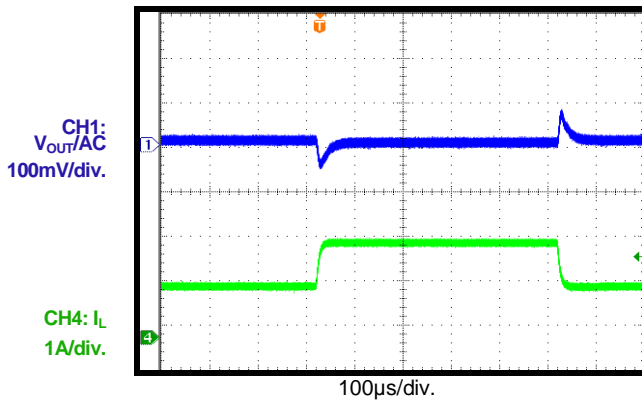

PRINTED CIRCUIT BOARD LAYOUT

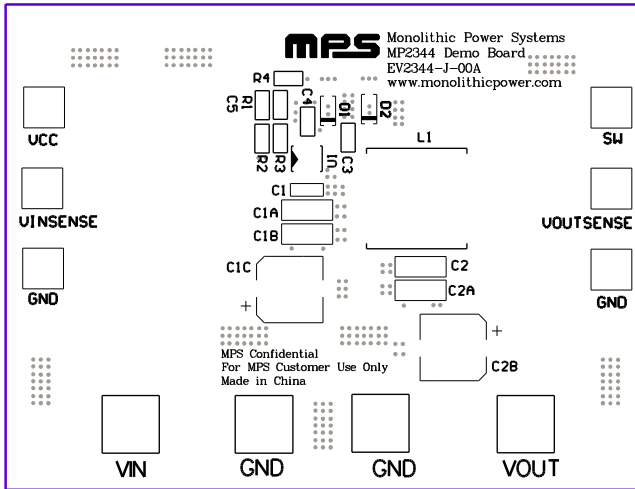

Figure 1—Top Silk Layer

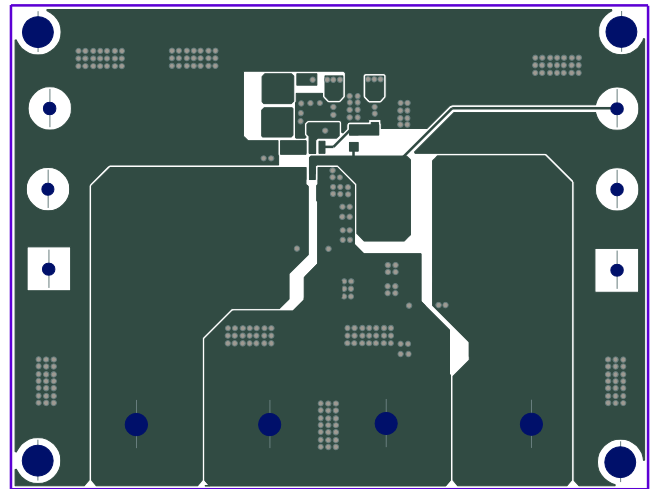

Figure 2—Top Layer

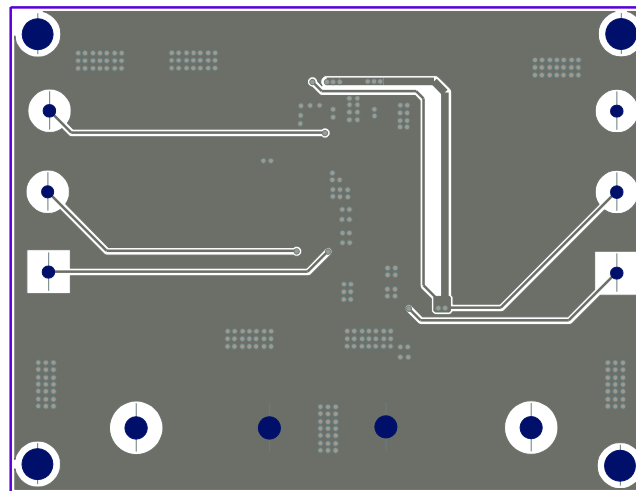

Figure 3—Bottom Layer

QUICK START GUIDE

1. Connect the positive and negative terminals of the load to the VOUT and GND pins, respectively.
2. Preset the power supply output between 7.5V and 26V, and then turn off the power supply.
3. Connect the positive and negative terminals of the power supply output to the VIN and GND pins, respectively.
4. Turn the power supply on. The board will automatically start up.

NOTICE: The information in this document is subject to change without notice. Please contact MPS for current specifications. Users should warrant and guarantee that third party Intellectual Property rights are not infringed upon when integrating MPS products into any application. MPS will not assume any legal responsibility for any said applications.