

### DESCRIPTION

The EV2388-QE-00A is an evaluation board for MP2388, a high frequency, synchronous, rectified, step-down converter with built-in Power MOSFETs. The MP2388 offers a very compact solution to achieve 1A continuous output current with excellent load and line regulation over a wide input supply range.

Current-mode operation provides fast transient response and eases loop stabilization.

Full protection features include over-current protection and thermal shutdown.

The MP2388 requires a minimum number of readily available standard external components and is available in a space saving QFN-8 (1.5mmx2.5mm) package.

### ELECTRICAL SPECIFICATION (1)

Parameter	Symbol	Value	Units
Input Voltage	$V_{IN}$	19	V
Output Voltage	$V_{OUT}$	3.3	V
Output Current	$I_{OUT}$	1	A

1). For different input, output spec, please refer to TYPICAL APPLICATION CIRCUIT section on datasheet to choose proper parameters.

### FEATURES

- 1A Continuous Load Current
- 110mΩ/50mΩ Low  $R_{DS(ON)}$  Internal Power MOSFETs
- Fixed 2MHz Switching Frequency
- High Efficiency Synchronous Mode Operation
- External AAM pin for Power-Save Mode Programming
- Internal Soft-Start
- Over Current Protection and Hiccup Mode
- Thermal Shutdown
- Output Adjustable from 0.8V
- Available in a QFN-8(1.5mm x 2.5mm) Package

### APPLICATIONS

- Notebook System and I/O Power
- Digital Set-Top Boxes
- Flat-Panel Television and Monitors

All MPS parts are lead-free and adhere to the RoHS directive. For MPS green status, please visit MPS website under Products, Quality Assurance page. "MPS" and "The Future of Analog IC Technology" are registered trademarks of Monolithic Power Systems, Inc.

## EV2388-QE-00A EVALUATION BOARD



Board Number	MPS IC Number
EV2388-QE-00A	MP2388GQEU

### Efficiency vs. Output Current

$V_{OUT}=3.3V$ ,  $L=1\mu H$ ,  $I_{OUT}=0.01A$  to  $1A$   
 $R_{AAM}=40.2k$  @  $V_{IN}=12V$  to  $21V$ ,  
 $R_{AAM}=80.6k$  @  $V_{IN}=5V$

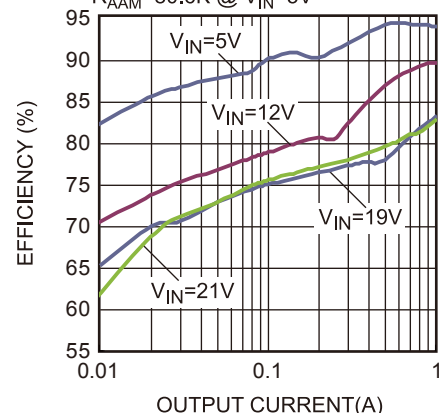

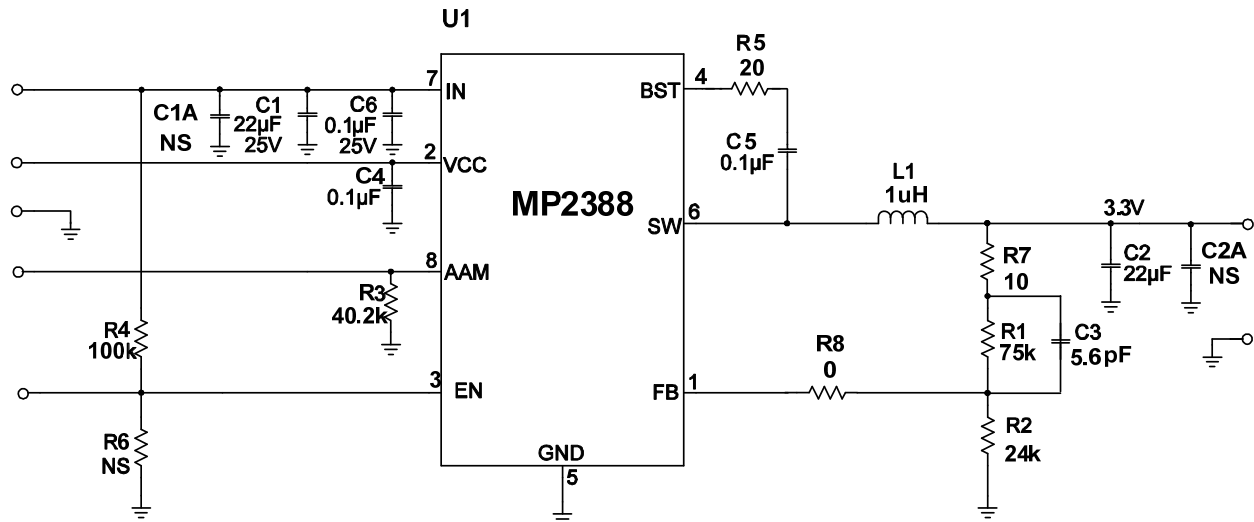
**EVALUATION BOARD SCHEMATIC**

**EV2388-QE-00A BILL OF MATERIALS**

Qty	Ref	Value	Description	Package	Manufacturer	Manufacturer P/N
0	C1A,C2A	NS				
1	C1	22 $\mu$ F	Ceramic Cap., 25V, X5R	0805	Murata	GRM21BR61E226ME44L
1	C2	22 $\mu$ F	Ceramic Cap., 16V, X5R	0805	Murata	GRM219R61C226ME15L
1	C3	5.6pF	Ceramic Cap., 50V, C0G	0603	Murata	GRM1885C1H5R6DA01D
2	C4,C5	0.1 $\mu$ F	Ceramic Cap., 16V, X7R	0603	Murata	GRM188R71C104KA01D
1	C6	0.1 $\mu$ F	Ceramic Cap., 25V, X7R	0603	Murata	GRM188R71E104KA01D
1	R1	75k $\Omega$	Film Res., 1%	0603	Yageo	RC0603FR-0775KL
1	R2	24k $\Omega$	Film Res., 1%	0603	Yageo	RC0603FR-0724KL
1	R3	40.2K $\Omega$	Film Res., 1%	0603	Yageo	RC0603FR-0740K24L
1	R4	100K $\Omega$	Film Res., 1%	0603	Yageo	RC0603FR-07100KL
1	R5	20 $\Omega$	Film Res., 1%	0603	Yageo	RC0603FR-0720RL
0	R6	NS				
1	R7	10 $\Omega$	Film Res., 1%	0603	Yageo	RC0603FR-0710RL
1	R8	0 $\Omega$	Film Res., 1%	0603	Yageo	RC0603FR-070RL
1	L1	1 $\mu$ H	Inductor, DCR=27m $\Omega$ , Isat=9A	SMD	Würth	74437324010
1	U1	MP2388	Step-Down Converter	QFN-8	MPS	MP2388GQEU

### EVB TEST RESULTS

Performance waveforms are tested on the evaluation board.  
 $V_{IN} = 19V$ ,  $V_{OUT} = 3.3V$ ,  $L = 1\mu H$ ,  $T_A = 25^\circ C$ , unless otherwise noted.

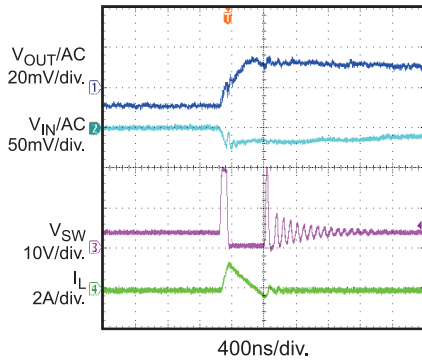
**Input/Output Ripple**  
 $I_{OUT} = 0A$



**Input/Output Ripple**  
 $I_{OUT} = 1A$

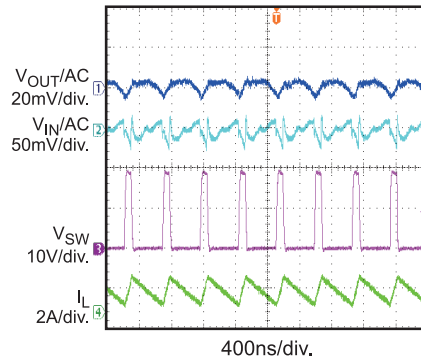

**Startup through Input Voltage**  
 $I_{OUT} = 0A$

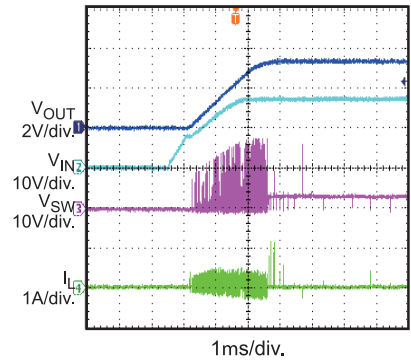

**Startup through Input Voltage**  
 $I_{OUT} = 1A$

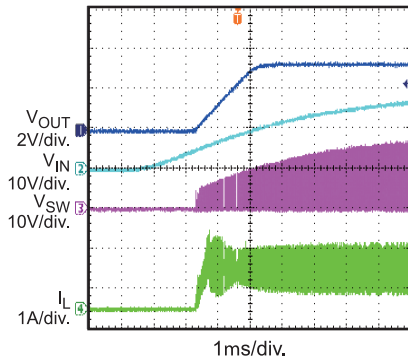

**Shutdown through Input Voltage**  
 $I_{OUT} = 0A$

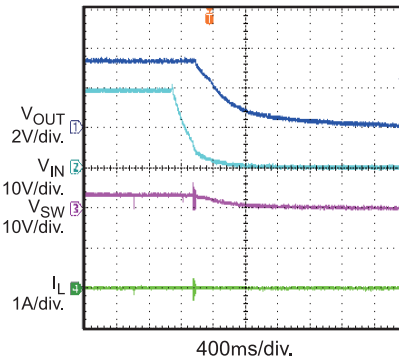

**Shutdown through Input Voltage**  
 $I_{OUT} = 1A$

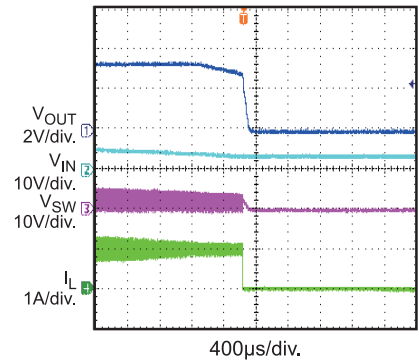

**Startup through Enable**  
 $I_{OUT} = 0A$

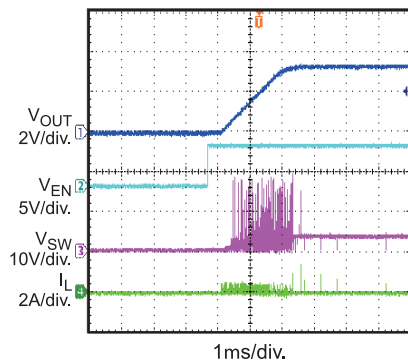

**Startup through Enable**  
 $I_{OUT} = 1A$

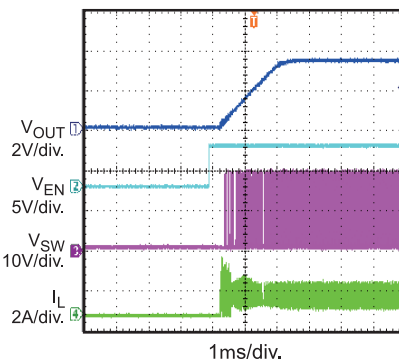

**Shutdown through Enable**  
 $I_{OUT} = 0A$

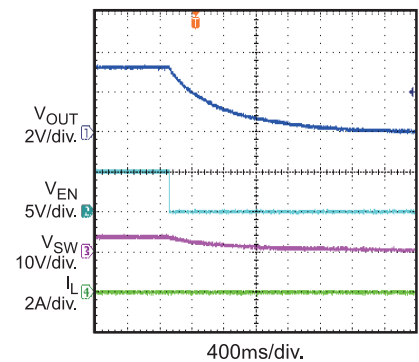

**EVB TEST RESULTS (continued)**

Performance waveforms are tested on the evaluation board.

$V_{IN} = 19V$ ,  $V_{OUT} = 3.3V$ ,  $L=1\mu H$ ,  $T_A=25^\circ C$ , unless otherwise noted.

**Shutdown through Enable**

$I_{OUT} = 1A$

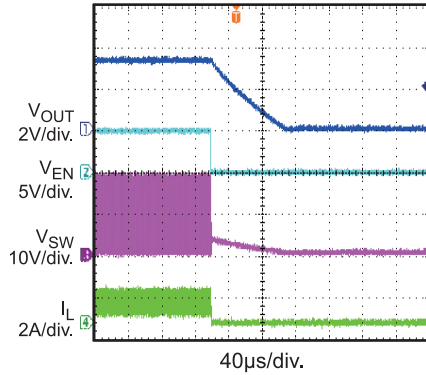

**Short Circuit Entry**

$I_{OUT} = 0A$

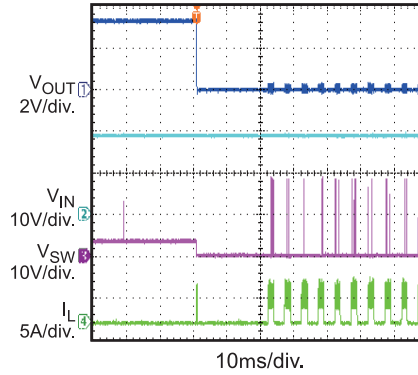

**Short Circuit Recovery**

$I_{OUT} = 0A$

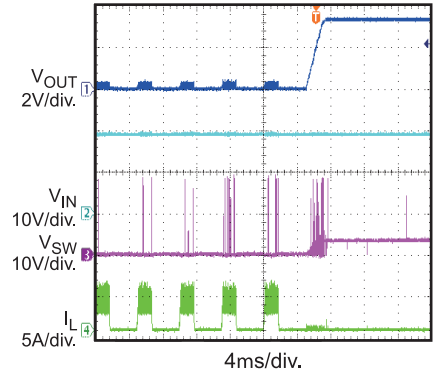

**Short Circuit Steady**

$I_{OUT} = 0A$

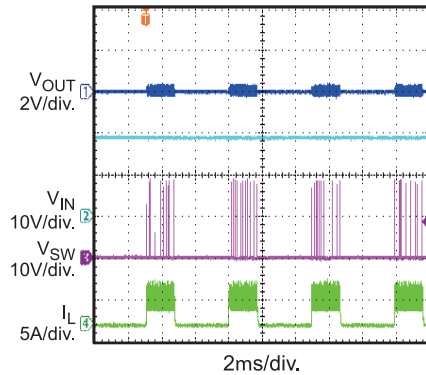

**Load Transient**

$I_{OUT} = 0.5A$  to  $1A$ ,  $2.5A/\mu s$

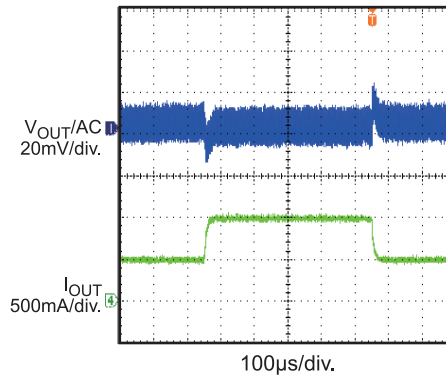

**PRINTED CIRCUIT BOARD LAYOUT**

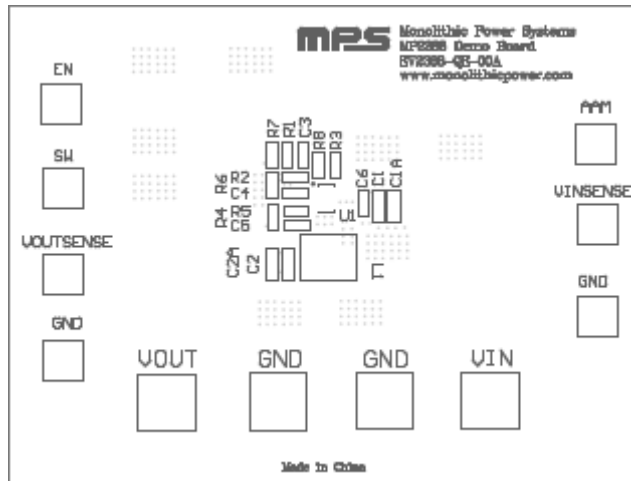

**Figure 1—Top Silk Layer**

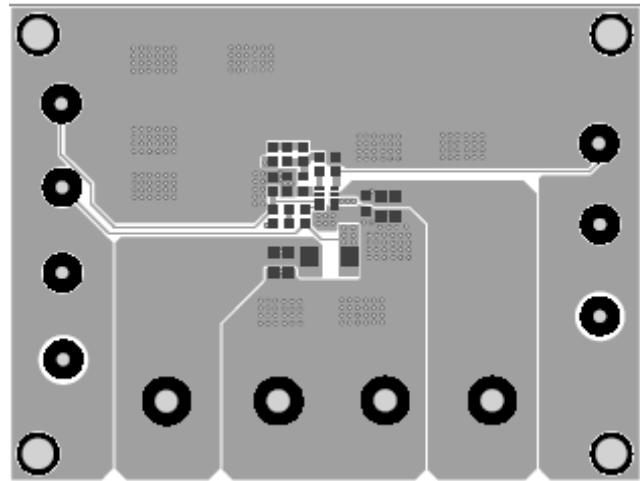

**Figure 2—Top Layer**

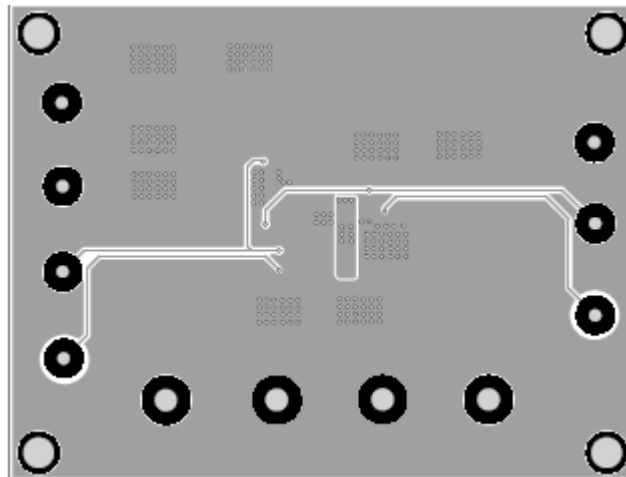

**Figure 3—Bottom Layer**

## QUICK START GUIDE

1. Connect the positive and negative terminals of the load to the VOUT and GND pins, respectively.
2. Preset the power supply output between 4.5V and 21V, and then turn off the power supply.
3. Connect the positive and negative terminals of the power supply output to the VIN and GND pins, respectively.
4. Turn the power supply on. The board will automatically start up.
5. To use the Enable function, apply a digital input to the EN pin. Drive EN higher than 1.6V to turn on the regulator, or less than 0.9V to turn it off.
6. Float AAM pin or drive AAM to a high level voltage to set MP2388 work at forced PWM mode.

**NOTICE:** The information in this document is subject to change without notice. Please contact MPS for current specifications. Users should warrant and guarantee that third party Intellectual Property rights are not infringed upon when integrating MPS products into any application. MPS will not assume any legal responsibility for any said applications.