

DESCRIPTION

The EV2454-H-00A is an evaluation board for the MP2454/MPQ2454, a frequency-programmable (350kHz to 2.3MHz) step-down switching regulator with integrated internal high-side high voltage power MOSFET. It efficiently outputs up to 0.6A, and has current-mode control for fast loop response.

The wide 3.3V-to-36V input range accommodates a variety of step-down applications in automotive-input environments. A 3.5 μ A shutdown-mode quiescent current allows for use in battery-powered applications. The device also has a high-duty cycle and low drop-out mode for automotive cold-crank conditions.

The MPQ2454 also achieves high power conversion efficiency over a wide load range by scaling down the switching frequency at light load conditions to reduce both switching and gate driving losses.

Frequency fold-back prevents inductor current runaway during start-up and short circuit. Thermal shutdown provides reliable, fault-tolerant operation. An open-drain power-good signal indicates the output is within its nominal voltage.

The EV2454-H-00A is assembled and tested with MSOP-10 package.

ELECTRICAL SPECIFICATIONS

Parameter	Symbol	Value	Units
Input Voltage	V_{IN}	3.3-36	V
Output Voltage	V_{OUT}	3.3	V
Output Current	I_{OUT}	0.6	A

FEATURES

- 60 μ A Operating Quiescent Current
- Wide 3.3V-to-36V Operating Input Range
- 200m Ω Internal Power MOSFET
- Up to 2.3MHz Programmable Switching Frequency
- Stable with Ceramic Output Capacitors
- Internal Compensation
- External Soft-Start
- > 90% Efficiency
- Low Dropout Operation for Cold-crank
- 3.5 μ A Low Shutdown Supply Current
- Synchronize to External Clock
- Power Good Output
- Programmable Power Good Delay Time
- Available in AEC-Q100 Grade 1
- Fully Assembled and Tested

APPLICATIONS

- High Voltage Power Conversion
- Automotive Systems
- Industrial Power Systems
- Distributed Power Systems
- Battery Powered Systems

All MPS parts are lead-free and adhere to the RoHS directive. For MPS green status, please visit MPS website under Quality Assurance. "MPS" and "The Future of Analog IC Technology" are Registered Trademarks of Monolithic Power Systems, Inc.

EV2454-H-00A EVALUATION BOARD



(L x W x H) 2.5" x 2.5" x 0.2"
(6.35cm x 6.35cm x 0.5cm)

Board Number	MPS IC Number
EV2454-H-00A	MPQ2454GH

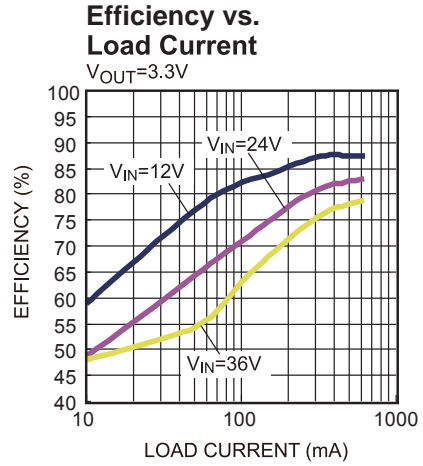

EVALUATION BOARD SCHEMATIC

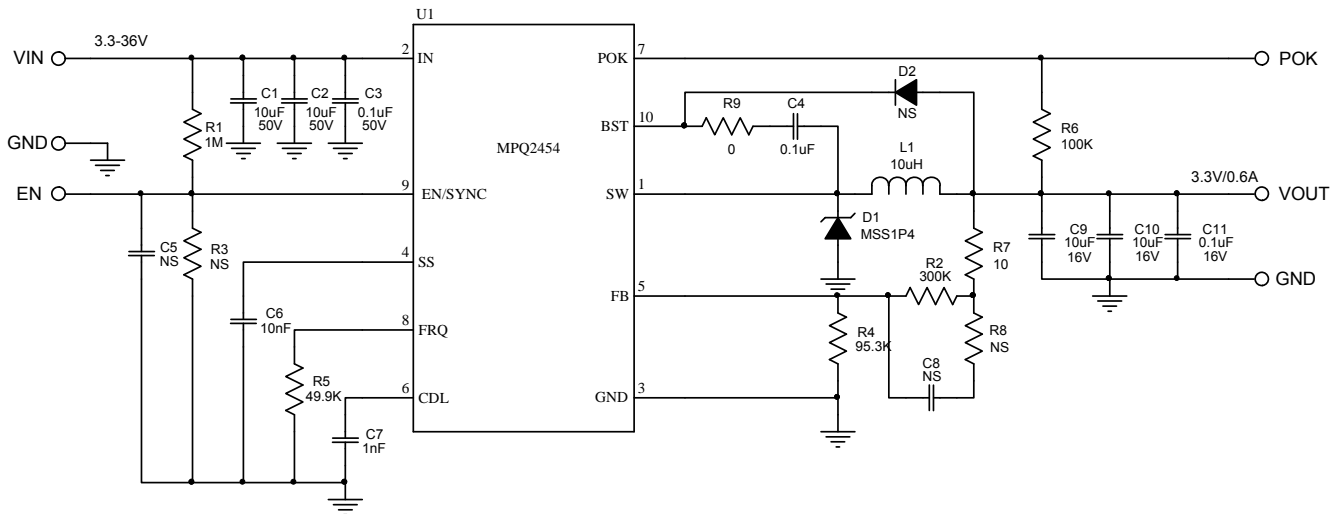

EV2454-H-00A BILL OF MATERIALS

Qty	RefDes	Value	Description	Package	Manufacture	Manufacture_PN
2	C1, C2	10 μ F	Ceramic Capacitor; 50V;X7R; 1210;	1210	muRata	GRM32ER71H106KA12L
3	C3, C4, C11	0.1 μ F	Ceramic Capacitor; 50V;X7R; 0603;	0603	muRata	GRM188R71H104KA93D
1	C6	10nF	Ceramic Capacitor; 50V;X7R; 0603;	0603	muRata	GRM188R71H103KA01D
1	C7	1nF	Ceramic Capacitor; 50V;C0G 0603;	0603	muRata	GRM1885C1H102JA01D
2	C9, C10	10 μ F	Ceramic Capacitor; 16V;X7R; 1210	1210	muRata	GRM32DR71C106KA01L
2	C5, C8	NS		0603		
1	D1	MSS1P4	Schottky Diode; 40V;1A;	MicroSMP	Vishay	MSS1P4
1	D2	1N4148WS	Diode; 75V; 0.15A;	SOD-323	Diodes	1N4148WS
1	L1	10 μ H	Inductor;10 μ H; 53m Ω ; 2.3 A	SMD	ABC	DM5028100ML
			Inductor;10 μ H; 52.8m Ω ;1.5A	SMD	SUMIDA	CDRH6D26NP-100NC
1	R1	1M	Film Resistor;5%;	0603	Yageo	RC0603JR-071ML
1	R2	300k	Film Resistor;1%;	0603	Yageo	RC0603FR-07300KL
1	R4	95.3k	Film Resistor;1%;	0603	Yageo	RC0603FR-0795K3L
1	R5	49.9k	Film Resistor;1%;	0603	Yageo	RC0603FR-0749K9L
1	R6	100k	Film Resistor;1%;	0603	Yageo	RC0603FR-07100KL
1	R7	10	Film Resistor;1%;	0603	Yageo	RC0603FR-0710RL
1	R9	0	Film Resistor;5%;	0603	Yageo	RC0603JR-070RL
2	R3, R8	NS		0603		
1	U1		Step-Down Regulator	MSOP-10	MPS	MPQ2454GH
4	VIN, GND VOUT, GND		2.0 Golden Pin		HZ	
3	EN,POK, GND		1.0 Golden Pin		HZ	

EVB TEST RESULTS

$V_{IN} = 12V$, $V_{OUT} = 3.3V$, $C_{OUT} = 2 \times 10\mu F$, $L = 10\mu H$, $T_A = +25^\circ C$, unless otherwise noted.

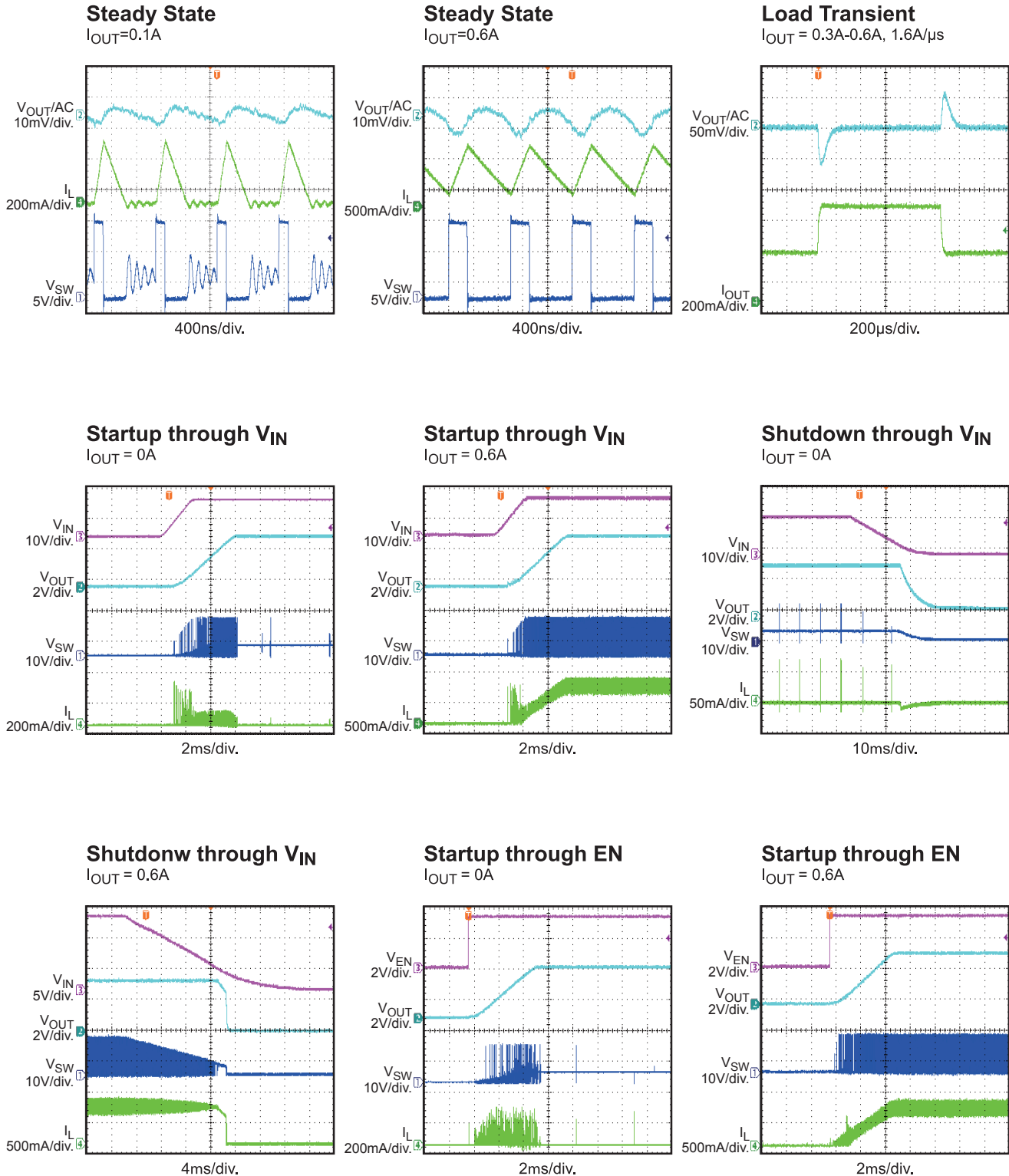

EVB TEST RESULTS (continued)
 $V_{IN} = 12V, V_{OUT} = 3.3V, C_{OUT} = 2 \times 10\mu F, L = 10\mu H, T_A = +25^\circ C$, unless otherwise noted.

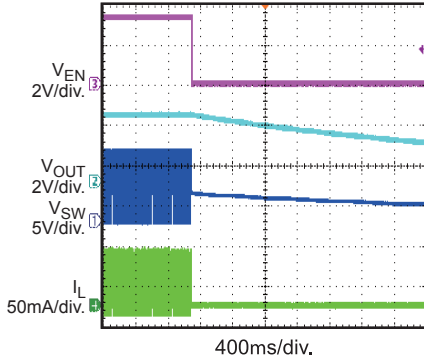
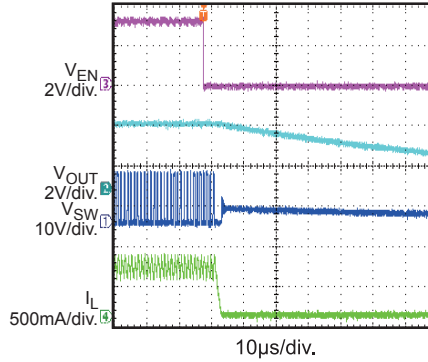
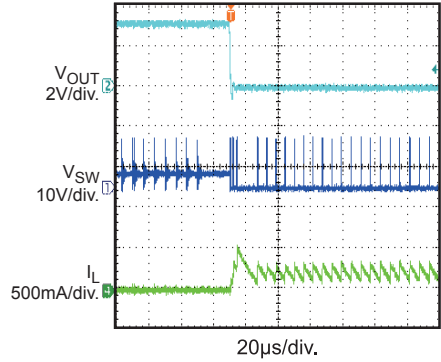
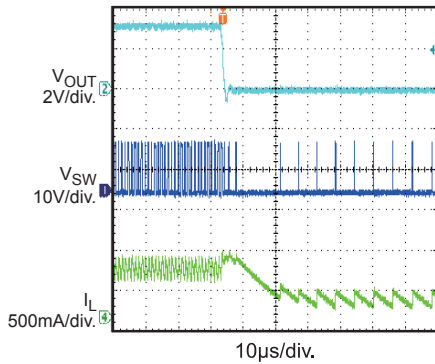
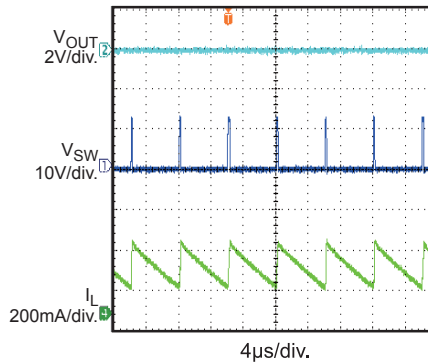
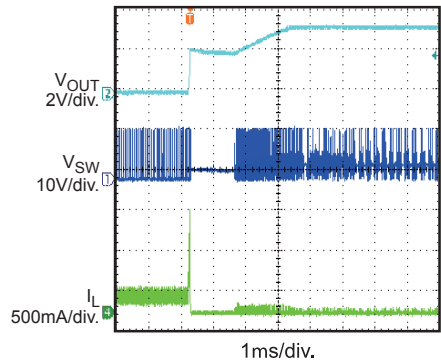
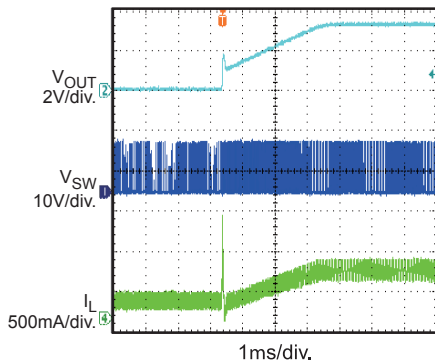
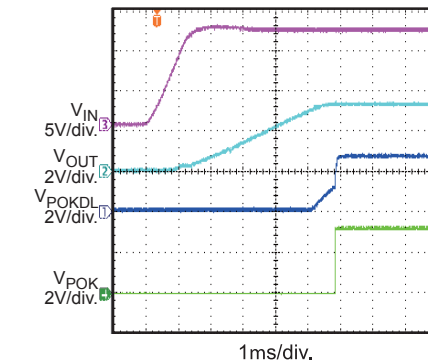
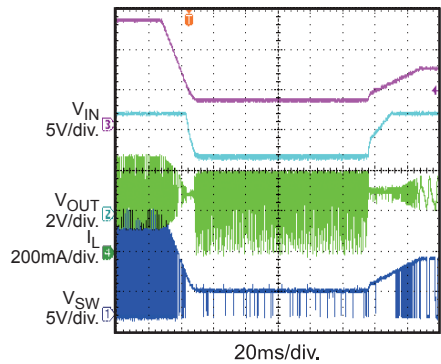
Shutdown through EN
 $I_{OUT} = 0A$

Shutdown through EN
 $I_{OUT} = 0.6A$

SCP Entry
 $I_{OUT} = 0A$ to Short Circuit

SCP Entry
 $I_{OUT} = 0.6A$ to Short Circuit

SCP Steady State

SCP Recovery
 Short Circuit to $I_{OUT} = 0A$

SCP Recovery
 Short Circuit to $I_{OUT} = 0.6A$

POK through Power On

Cold-Crank
 $V_{OUT} = 5V, I_{OUT} = 0.3A$

PRINTED CIRCUIT LAYOUT

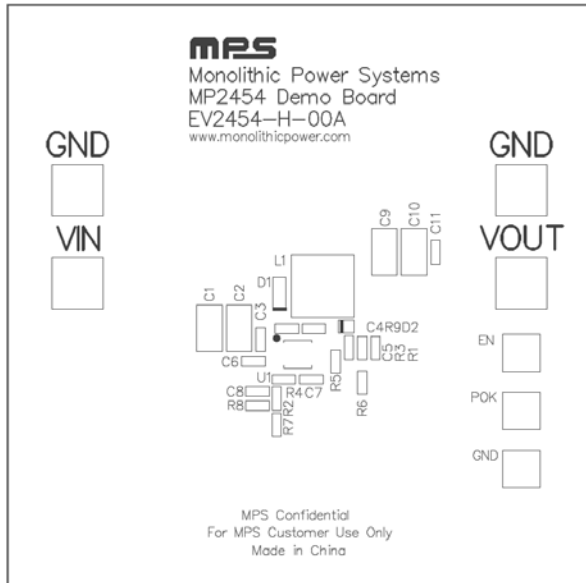

Figure1 – Top Silk Layer

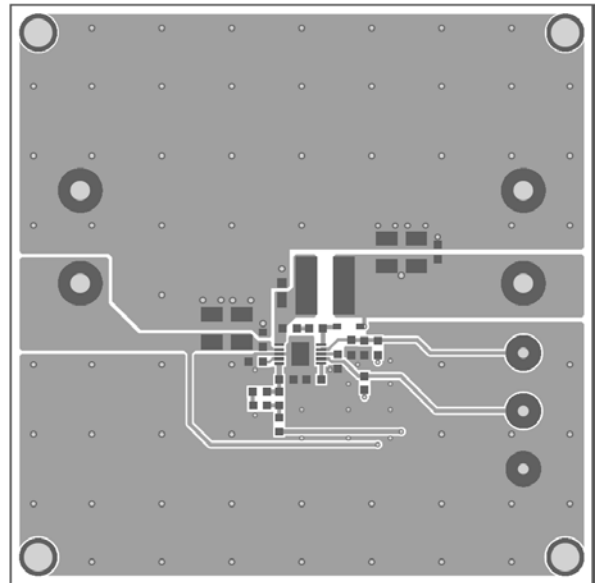

Figure 2 – Top Layer

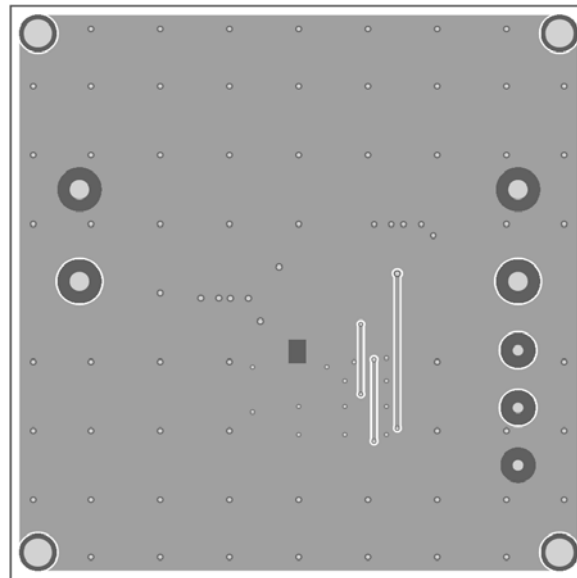

Figure3 – Bottom Layer

QUICK START GUIDE

1. Connect the positive and negative terminals of the load to the VOUT and GND pins respectively.
2. Preset the power supply output to between 3.3V to 36V, and then turn it off.
3. Connect the positive and negative terminals of the power supply output to the VIN and GND pins respectively.
4. Turn the power supply on. The MP2454/MPQ2454 will automatically startup.
5. To use the Enable function, apply a digital input to the EN pin. Drive EN higher than 1.8V for longer than 200ns to turn on the regulator, drive EN less than 1 V for longer than 2 μ s to turn it off. There is an internal 1.2M Ω resistor between EN and GND, so floating this pin shuts chip down.
6. Connect the EN input pin through a pull-up resistor to any voltage connected to the VIN pin—the pull-up resistor is selected to limit the EN input current to less than 150 μ A to prevent damaging internal Zener diode. For example, with 12V connected to VIN, $R_{PULLUP} \geq (12V - 7.5V) \div (150+7.5/1.2)\mu A = 28.8k\Omega$.
7. Connect the EN pin directly to a voltage source without any pull-up resistor requires limiting voltage amplitude to $\leq 7.5V$ to prevent damage to the internal Zener diode.
8. Connect the EN input pin with an external clock with a range of 350kHz to 2.3MHz after output voltage is set to synchronize the internal clock rising edge to the external clock rising edge.

NOTICE: The information in this document is subject to change without notice. Users should warrant and guarantee that third party Intellectual Property rights are not infringed upon when integrating MPS products into any application. MPS will not assume any legal responsibility for any said applications.