

DESCRIPTION

The MP24830 is a 90V, white LED driver suitable for inverting step-up/down applications. It supports a wide input range with excellent load and line regulation. Its programmable current limit provides customized applications with wide power range. Current mode operation provides fast transient response and eases loop stabilization. Fault condition protection includes thermal shutdown, cycle-by-cycle peak current limiting, open strings protection and output short circuit protection.

The MP24830 incorporates both DC and PWM dimming onto a single control pin. The separate input reference ground pin allows for direct enable and/or dimming control for a positive to negative power conversion

ELECTRICAL SPECIFICATION

Parameter	Symbol	Value	Units
Input Voltage	V _{IN}	8 To (V _{IN} +V _{OUT})<50	V
Enable Voltage	V _{EN}	5	V
LED Current	I _{LED}	1	A
Switching Frequency	F _S	200	kHz
Output Voltage Protection	V _{OV} P	30	V

FEATURES

- Programmable Maximum Output Current
- Unique Operation (Buck-Boost Mode)
- Wide 8V to 24V Operating Input Range
- Adjustable Switching Frequency
- Analog and PWM Dimming
- 0.2V Reference Voltage
- 5µA Shutdown Mode
- No Minimum LED Required
- Stable with Low ESR Output Ceramic Capacitors
- Cycle-by-Cycle Over Current Protection
- Thermal Shutdown Protection
- Open Strings Protection
- Output Short Circuit Protection
- Available in QFN14

APPLICATIONS

- General LED Illuminations
- Automotive LED Lighting
- TV Backlighting System
- LCD Backlight Panels
- Handheld Computers

All MPS parts are lead-free, halogen free, and adhere to the RoHS directive. For MPS green status, please visit MPS website under Quality Assurance.

"MPS" and "The Future of Analog IC Technology" are Registered Trademarks of Monolithic Power Systems, Inc.

ADAM (Analog Digital Adaptive Modulation) and AAM (Advanced Asynchronous Mode) are trademarks of Monolithic Power Systems, Inc.

EV24830- L-00A EVALUATION BOARD



(L x W x H) 95mm x 21mm x 15mm	
Board Number	MPS IC Number
EV24830-L-00A	MP24830HL

Efficiency vs. LED String Voltage

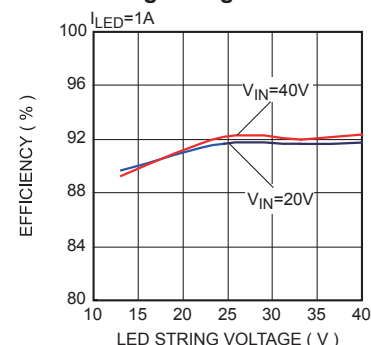

EVALUATION BOARD SCHEMATIC

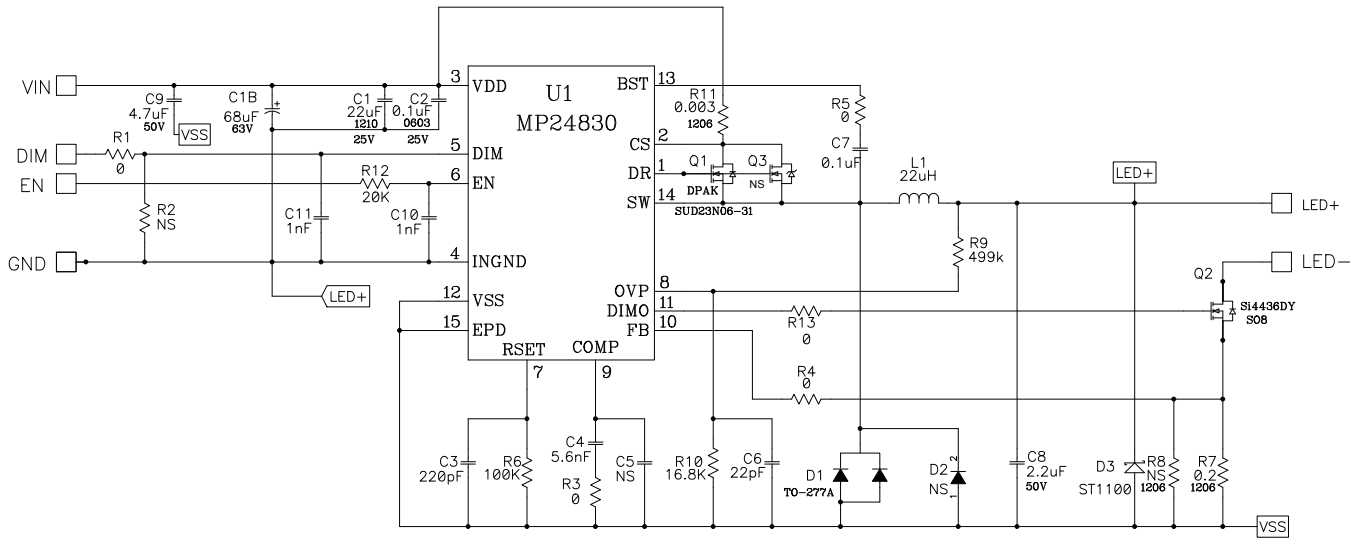

EV24830- L-00A BILL OF MATERIALS

Qty	RefDes	Value	Description	Package	Manufacturer	Manufacturer P/N
1	C1	22 μ F	Ceramic Cap., 25V, 10%, X7R	1210	muRata	GRM32ER71E226KE15L
1	C1B	68 μ F	Alu Cap., 35V, 10%,	6 x12x2.5mm	any	any
2	C2, C7	0.1 μ F	Ceramic Cap., 50V, 10%, X7R	0603	muRata	GRM188R71H104KA93D
1	C3	220pF	Ceramic Cap., 50V, 10%, X7R	0603	muRata	GRM188R71H221KA01D
1	C4	5.6nF	Ceramic Cap., 50V, 10%, X7R	0603	muRata	GRM188R71H562KA01D
	C5	NS				
1	C6	22pF	Ceramic Cap., 50V, 5%, C0G	0603	muRata	GRM1885C1H220JA01D
1	C8	2.2 μ F	Ceramic Cap., 50V, 10%, X7R	1206	muRata	GRM31CR71H225KA88K
1	C9	4.7 μ F	Ceramic Cap., 50V, 10%, X7R	1210	muRata	GRM32ER71H475KA88L
2	C10, C11	1nF	Ceramic Cap., 50V, 10%, X7R	0603	muRata	GRM188R71H102KA01D
1	D1	8A	Schottky Rect., 100V, 8A	TO-277A	Vishay	V8P10
	D2	NS				
1	D3	1A	Schottky Rect., 100V, 1A	SMA	Diodes	B1100
1	L1	22 μ H	Inductor, Rdc 15m Ω , Isat 11A	SMD 18x18mm	Würth Elektronik	74435572200
5	R1, R3, R4, R5, R13	0	Film Res., 5%	0603	Yageo	RC0603JR-070RL
	R2	NS		0603		
1	R6	100K Ω	Film Res., 1%	0603	Yageo	9C06031A1003FKHFT
1	R7	200m Ω	Film Res.1/2W, 1%	1206	Cyntec	RLT1632-4-R200-FNH
	R8	NS		1206		
1	R9	499K Ω	Film Res., 1%	0603	Yageo	9C06031A4993FKHFT
1	R10	16.8K	Film Res., 1%	0603	Yageo	9C06031A2002FKHFT
1	R11	3m Ω	Film Res., 1/2W, 1%	1206	Stackpole Electronics	CSNL1206FT3L00
1	R12	20K	Film Res., 5%	0603	Yageo	9C06031A5102FKHFT
1	Q1	N-MOS	60V Mosfet SUD23N06	D-Pak	Vishay	SUD23N06-31
1	Q2	N-MOS	80V Mosfet Si4436DY	SO-8	Vishay	Si4436DY
	Q3	NS		TO-220		
1	U1	MP24830	Power Led Driver	QFN14	MPS	MP24830HL
1	EN, DIM, GND		3 Pin Header, 2.54mm	2.54mm	Sullins	PCC03SAAN
4	LED+, LED-, VIN, GND		2.3 pillar	W200D100	HZ	China

EVB TEST RESULTS

Performance waveforms are tested on the evaluation board.

$V_{EN}=5V$, $V_{IN}=12V$, $I_{OUT}=1A$, $L=22\mu H$, $T_A=25^\circ C$, Unless otherwise noted.

Efficiency vs. Input Voltage

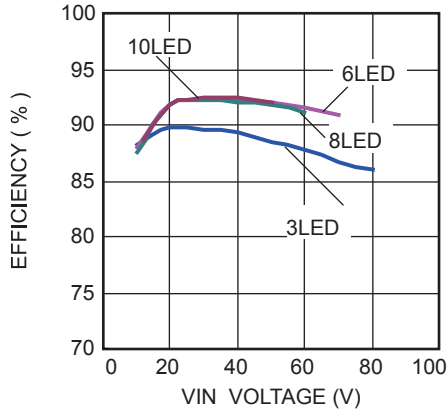

Efficiency vs. LED String Voltage

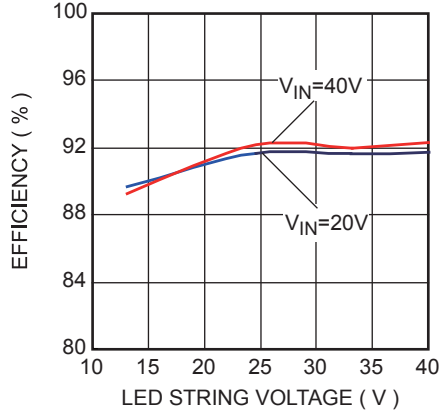

I_{LED} Line Regulation vs. VIN

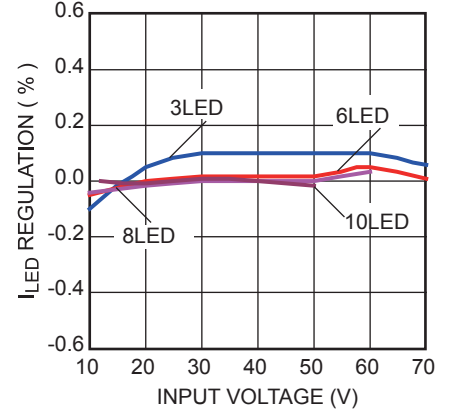

I_{LED} vs. PWM Dimming

$V_{IN}=25V$, 3LED, $F_{DIM}=0.2kHz$

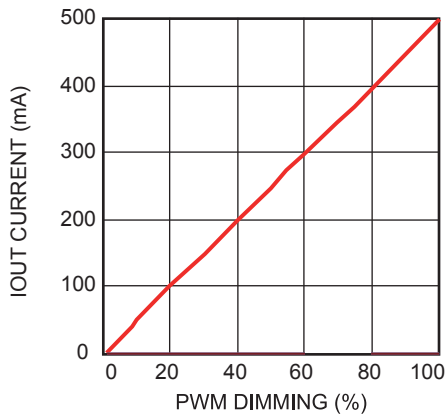

I_{LED} vs. Analog Dimming

$V_{IN}=20V$, 3LED, $I_{OUT}=1A$, $F_{DIM}=0.2kHz$

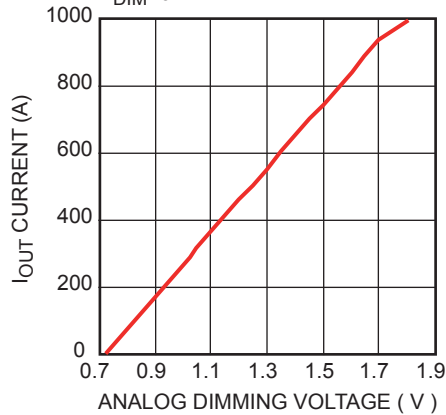

EVB TEST RESULTS (continued)

Performance waveforms are tested on the evaluation board.

$V_{EN}=5V$, $V_{IN}=12V$, $I_{OUT}=1A$, $L=22\mu H$, $T_A=25^\circ C$, Unless otherwise noted.

Steady State

$V_{IN}=8V$, 3LED, $I_{OUT}=1A$

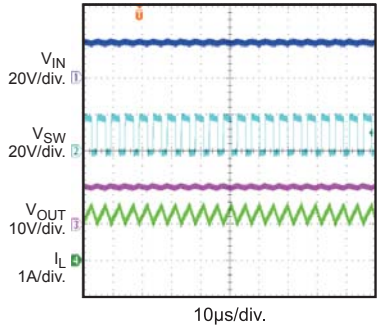

PWM Dimming

$V_{IN}=25V$, 3LED, $F_{DIM}=200Hz/50\%$

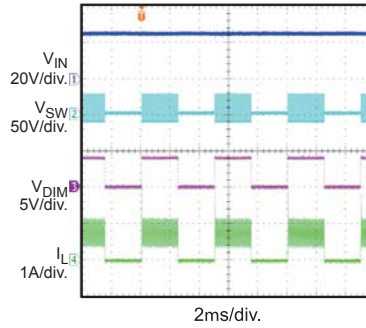

Analog Dimming

$V_{IN}=25V$, 3LED, $V_{DIM}=0.9V$

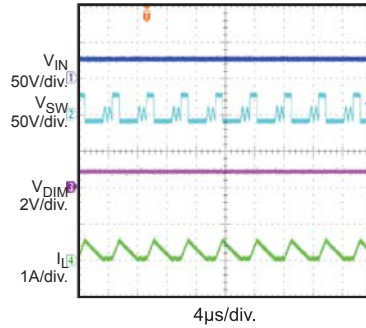

Power Ramp Up

$V_{IN}=8V$, 3LED

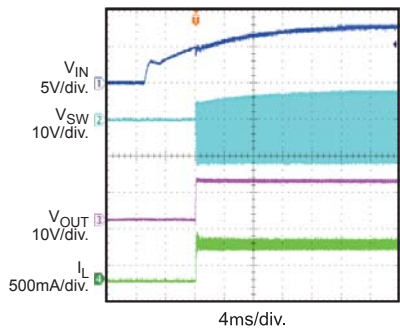

Open LED Protection

$V_{IN}=25V$, 3LED, $I_{LED}=1A$

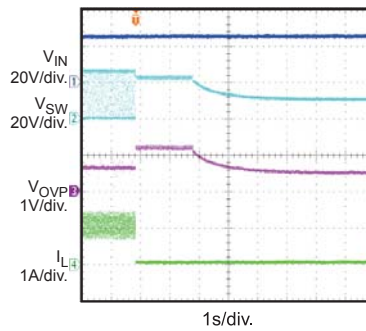

Enable Power Up

$V_{IN}=25V$, 3LED

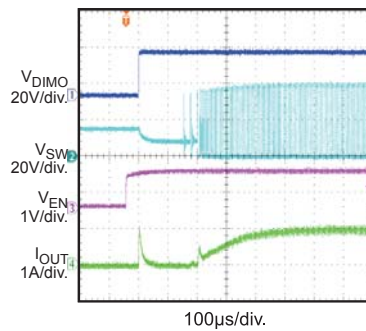

Enable Power Down

$V_{IN}=25V$, 3LED

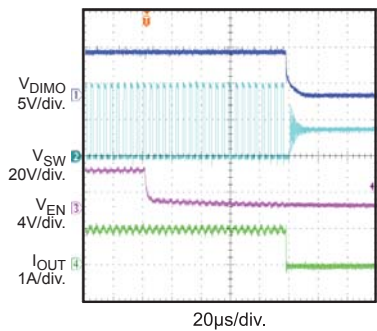

Short LED Protection

$V_{IN}=16V$, 3LED

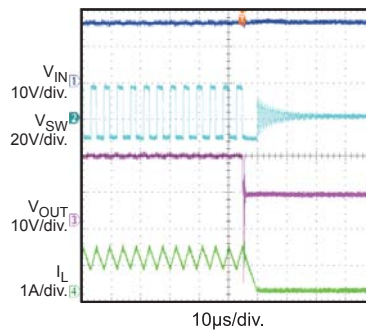

Short LED To VSS

$V_{IN}=25V$, 3LED

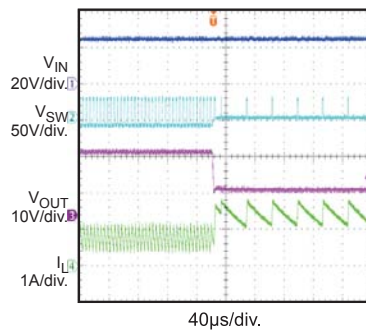

PRINTED CIRCUIT BOARD LAYOUT

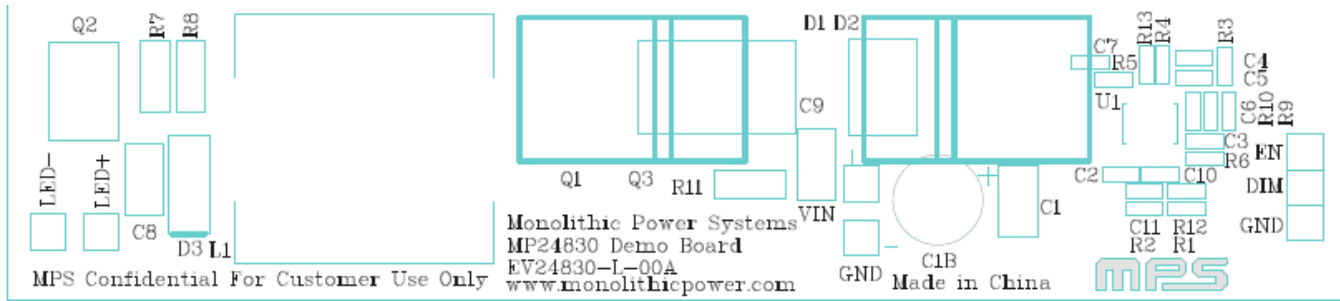

Figure 1—Top Silk Layer

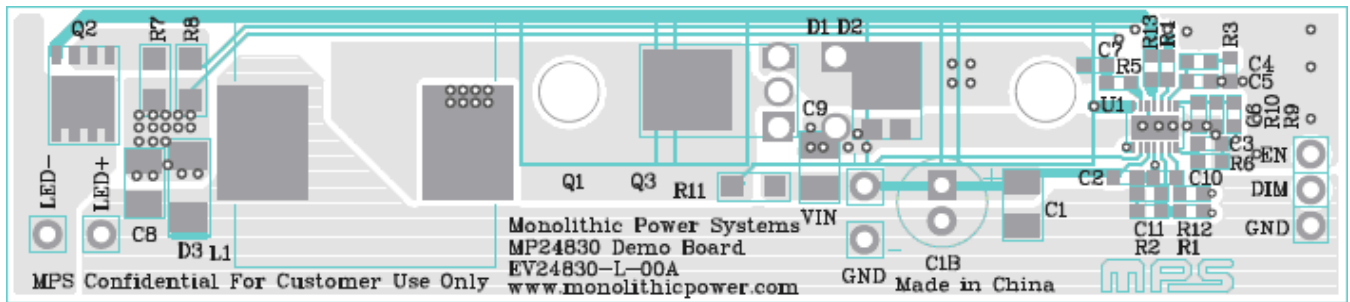

Figure 2—Top Layer

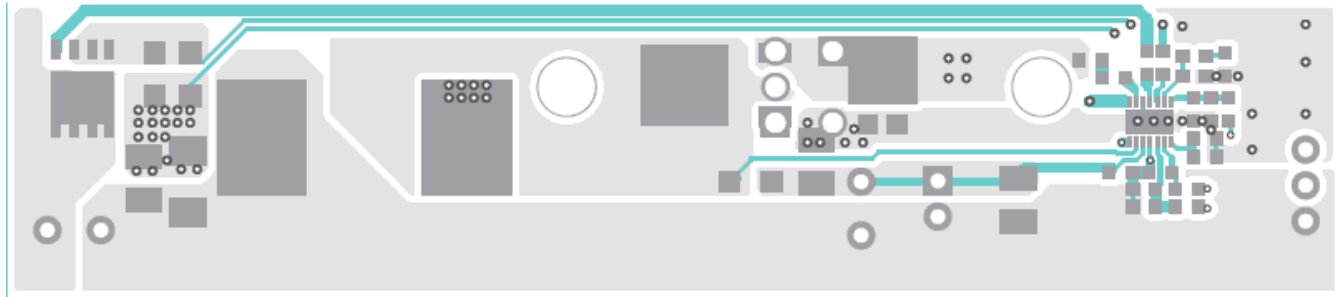

Figure 3—Top Layer

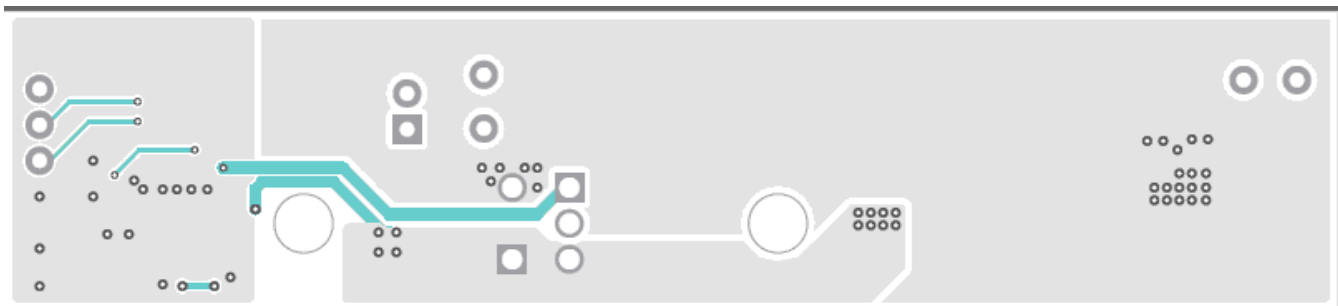

Figure 4—Bottom Layer

QUICK START GUIDE

1. Connect the LED string between “LED+” (anode of LED string) and “LED-“(cathode of LED string). The LED string voltage should be Less than 30V (8 LED string voltage is about 28V), since the output voltage protection is about 30V.
2. Set a VIN power supply voltage (range from 8V to $V_{IN}+V_{OUT} < 50V$) and connect the input between the “VIN” and “INGND” terminals as shown in the EVB board.
3. Set a second power supply 5V as the EN input supply to the EVB.
4. Turn-off all power supplies.
5. Turn-on the input voltage power supply.
6. Turn on the 5V EN power supply. All the LED strings should be lighted.
7. The switching frequency was set by R6, which is about 200kHz.
8. To demo the dimming function on DIM connector: using a function generator set the PWM signal amplitude to 5V and the frequency within 100Hz to 20kHz range for PWM dimming. For analog dimming, adjust the power supply from 0.7V to 2V.

NOTICE: The information in this document is subject to change without notice. Please contact MPS for current specifications. Users should warrant and guarantee that third party Intellectual Property rights are not infringed upon when integrating MPS products into any application. MPS will not assume any legal responsibility for any said applications.