

DESCRIPTION

The EV24894-J-00A is an evaluation board for the MP24894GJ, a high-efficiency step-down controller. It is designed to function in continuous current mode to power LEDs of high-brightness with a wide input voltage range of 6V to 60V.

The MP24894 employs a hysteretic control architecture that accurately regulates LED current; with a feedback coming from an external high-side current-sensing resistor. This control scheme optimizes circuit stabilization and fast response time without loop compensation. Its low 200mV average feedback voltage reduces power loss and improves the converter's efficiency.

The MP24894 implements PWM and analog dimming together through the EN/DIM pin.

The MP24894 includes thermal overload protection in the case of output overload.

ELECTRICAL SPECIFICATIONS

Parameter	Symbol	Value	Units
Input Voltage	V_{IN}	6 –60	V
Output Voltage	V_{OUT}	$<V_{IN}$	
LED Current	I_{LED}	1	A

FEATURES

- Wide 6V to 60V Input Range
- Able to Drive >1A LED Current
- High Efficiency (>95%)
- Hysteresis Control
- 2500:1 PWM Dimming Resolution
- Thermal Shutdown
- Integrated Open LED Protection
- Short LED Protection
- Available in TSOT6 Packages

APPLICATIONS

- Low Voltage Halogen Replacement
- Low Voltage General Illumination
- Automotive/Decorative LED Lighting
- Signs/Emergency Lighting
- LED Backlighting

All MPS parts are lead-free and adhere to the RoHS directive. For MPS green status, please visit MPS website under Quality Assurance. "MPS" and "The Future of Analog IC Technology" are Registered Trademarks of Monolithic Power Systems, Inc.

EV24894-J-00A EVALUATION BOARD

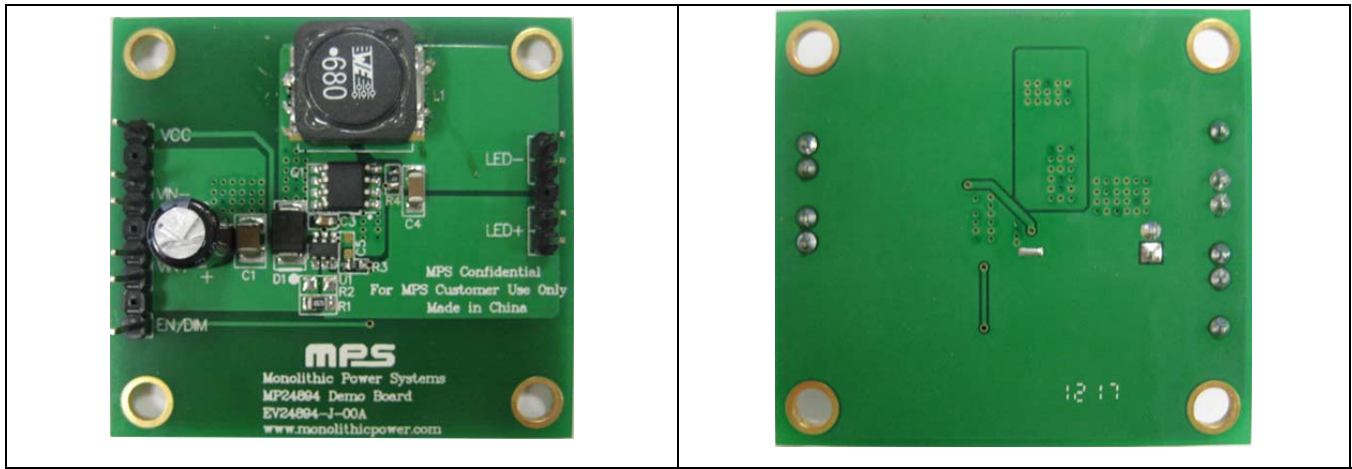

(L x W x H) 5cm x4.5cm x 1.0cm

Board Number	MPS IC Number
EV24894-J-00A	MP24894GJ

EVALUATION BOARD SCHEMATIC

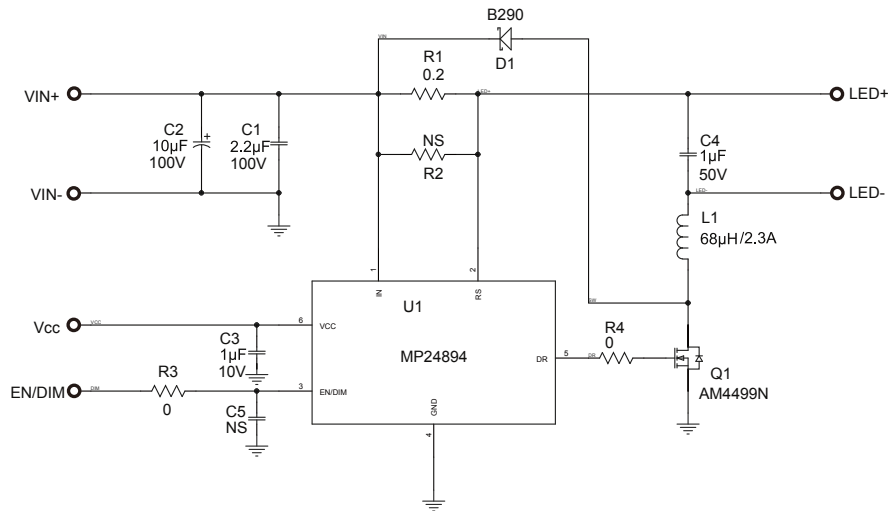

EV24894-J-00A BILL OF MATERIALS

Qty	Ref	Value	Description	Package	Manufacturer	Part Number
1	C1	2.2 μ F	Ceramic Capacitor, 100V,X7R	1210	muRata	GRM32ER72A225KA35L
1	C2	10 μ F	Electrolytic Capacitor, 100V	DIP		10 μ F./100V
1	C3	1 μ F	Ceramic Capacitor, 10V,X7R	0603	muRata	GRM188R71A105KA61D
1	C4	1 μ F	Ceramic Capacitor, 50V,X7R	1206	muRata	GRM31MR71H105KA88L
1	C5	NS		0603		
1	D1	B290	Diode Schottky	SMB	Diodes Inc.	B290
1	L1	68 μ H	Inductor 2.3A	SMD	Würth	744771168
1	R1	0.2 Ω	1%	0805	Yageo	RC0805FR-070R2L
1	R2	NS		0805		
2	R3,R4	0 Ω	5%	0603	Yageo	RC0603FR-070RL
1	Q1	AM4490N	100V/5.2A	SO8	Analog Power	AM4490N
1	U1	MP24894GJ	MPS WLED Driver	TSOT6	MPS	MP24894GJ-Z

EVB TEST RESULTS

Performance waveforms are tested on the evaluation board.
 $V_{IN}=24V$, 3LEDs, $I_{OUT}=1A$, $T_A = 25^\circ C$, unless otherwise noted.

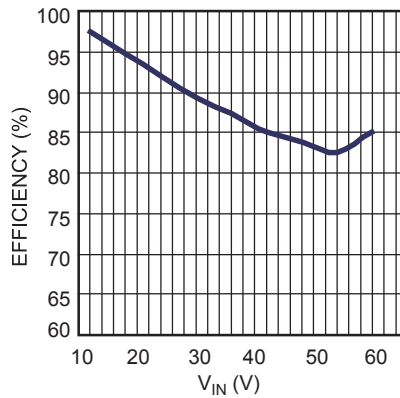
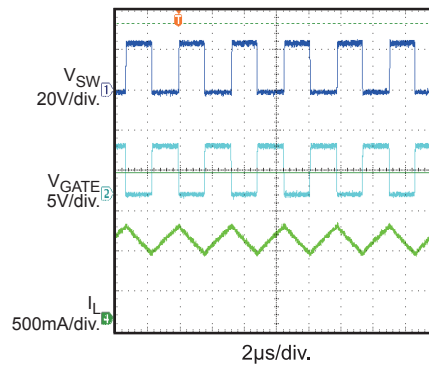
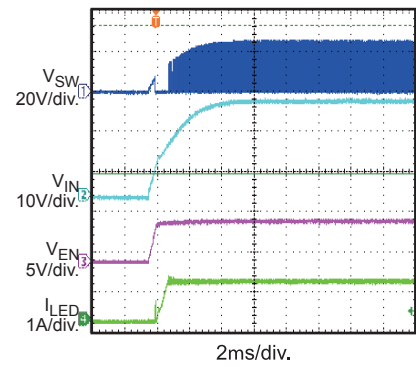
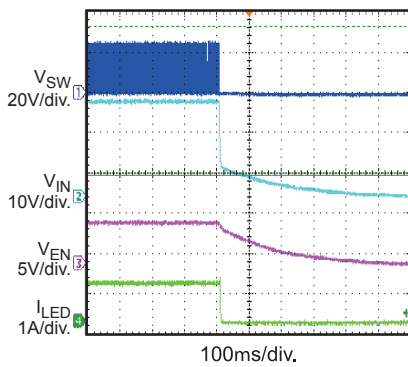
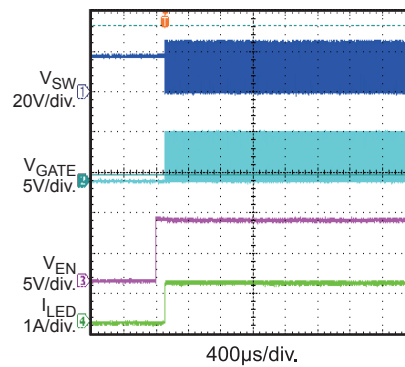
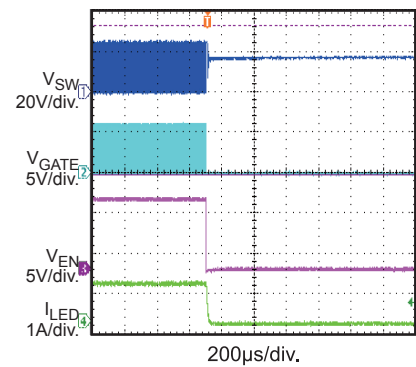
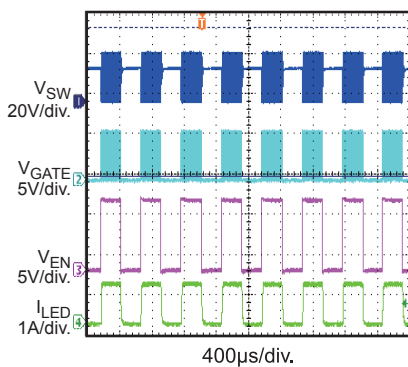
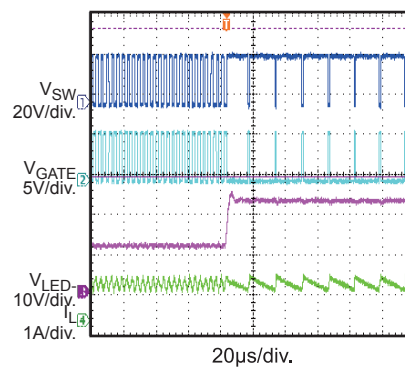
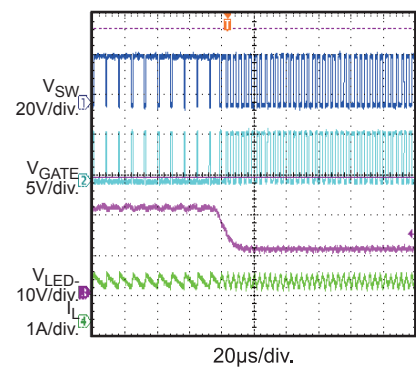
Efficiency

Steady State

Input Power On

Input Power Off

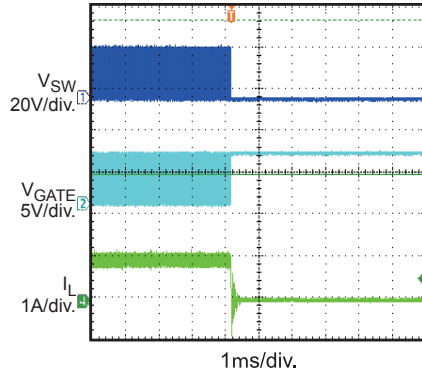
EN Power On

EN Power Off

PWM Dimming
 (2kHz, 50%)

Short LED+ to LED- Protection

Short LED+ to LED- Recovery

EVB TEST RESULTS

Performance waveforms are tested on the evaluation board.
 $V_{IN}=24V$, 3LEDs, $I_{OUT}=1A$, $T_A = 25^{\circ}C$, unless otherwise noted.

Open LED Load Protection



Open LED Load Recovery

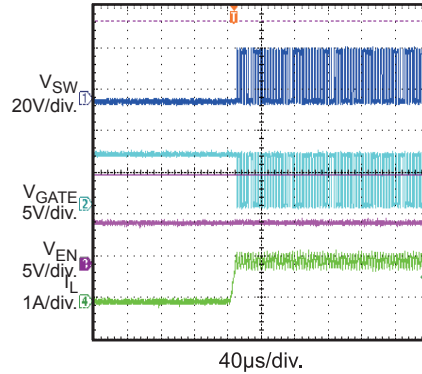

PRINTED CIRCUIT BOARD LAYOUT

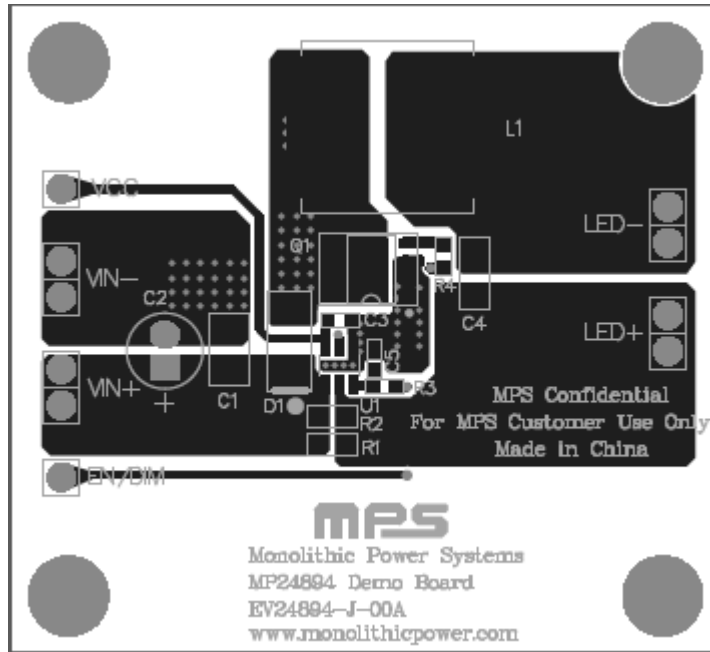

Figure 1—Top Layer

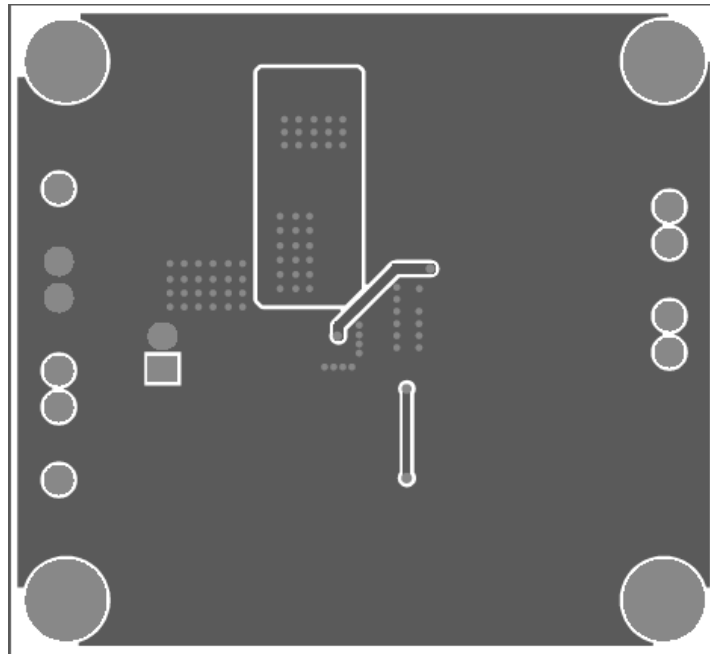

Figure 2—Bottom Layer

QUICK START GUIDE

1. Connect the positive and negative terminals of a LED string to the LED+ and LED- pins on the EV board, respectively.
2. Connect the positive and negative terminals of the power supply (6V - 60V) to the VIN+ and VIN- pins on the EV board, respectively.
3. For PWM dimming, apply a PWM rectangular waveform with a minimum voltage less than 0.25V and a maximum greater than 3V on DIM pin. The frequency of the PWM signal is recommended between 100Hz to 20kHz.
4. For analog dimming, apply a DC voltage between 0.3V and 2.7V on DIM pin. When the voltage on DIM is from 0.3V to 2.7V, the LED current will change from 20% to 100% of the maximum LED current.

NOTICE: The information in this document is subject to change without notice. Users should warrant and guarantee that third party Intellectual Property rights are not infringed upon when integrating MPS products into any application. MPS will not assume any legal responsibility for any said applications.