



The Future of Analog IC Technology®

EV2491C-QB-00A

6A, 32V Step-Down Converter With Programmable Current Limit And Output Voltage Scaling Control

DESCRIPTION

The EV2491C-QB-00A is an evaluation board for MP2491C, which integrates high voltage step-down converter. It achieves 6A continuous output current over a wide input supply range with excellent load and line regulation.

For MP2491C, Constant On-Time control operation provides very fast transient response and easy loop design as well as very tight output regulation.

Fault condition protection includes OCP, hiccup current limiting, output OVP and thermal shutdown.

The MP2491C requires a minimum number of readily available standard external components. The MP2491C is available in QFN-13 (2.5mmx3mm) package.

ELECTRICAL SPECIFICATION

Parameter	Symbol	Value	Units
Input Voltage	V_{IN}	24	V
Default Output Voltage	V_{OUT}	5	V
Output Current	I_{OUT}	6	A

FEATURES

- Wide 4.0V to 32V Operating Input Range
- 0.5V-30V Output Voltage Range
- 6A Output Current
- COT Control
- 2 Dedicate Voltage Scaling Control pins (DVS)
- Slew Rate Control during DVS
- Low Dropout Mode Operation
- 33mΩ/22mΩ Internal MOSFET Switches
- 450μA IQ
- Fixed 490kHz Switching Frequency
- Output Line Drop Compensation
- EN Shutdown Discharge
- Output Over Voltage Protection
- Adjustable Auto PFM/PWM Mode or Force PWM Mode
- Adjustable Current Limit
- Power Good Indication

APPLICATIONS

- TV, Monitor
- MFP Power Supply
- USB Power Supplies with PD
- Automotive Cigarette Lighter Adapters

All MPS parts are lead-free, halogen free, and adhere to the RoHS directive. For MPS green status, please visit MPS website under Quality Assurance. "MPS" and "The Future of Analog IC Technology" are Registered Trademarks of Monolithic Power Systems, Inc.

EV2491C-QB-00A EVALUATION BOARD

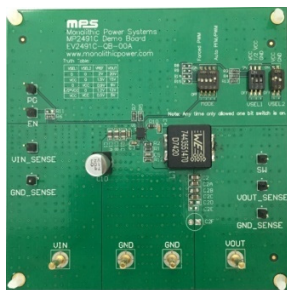

(L×W)8.5cm× 8.5cm

Board Number	MPS IC Number
EV2491C-QB-00A	MP2491CGQB

Efficiency vs. Load Current

$V_{IN}=24V$

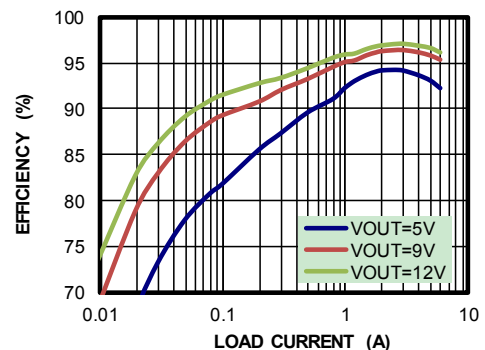

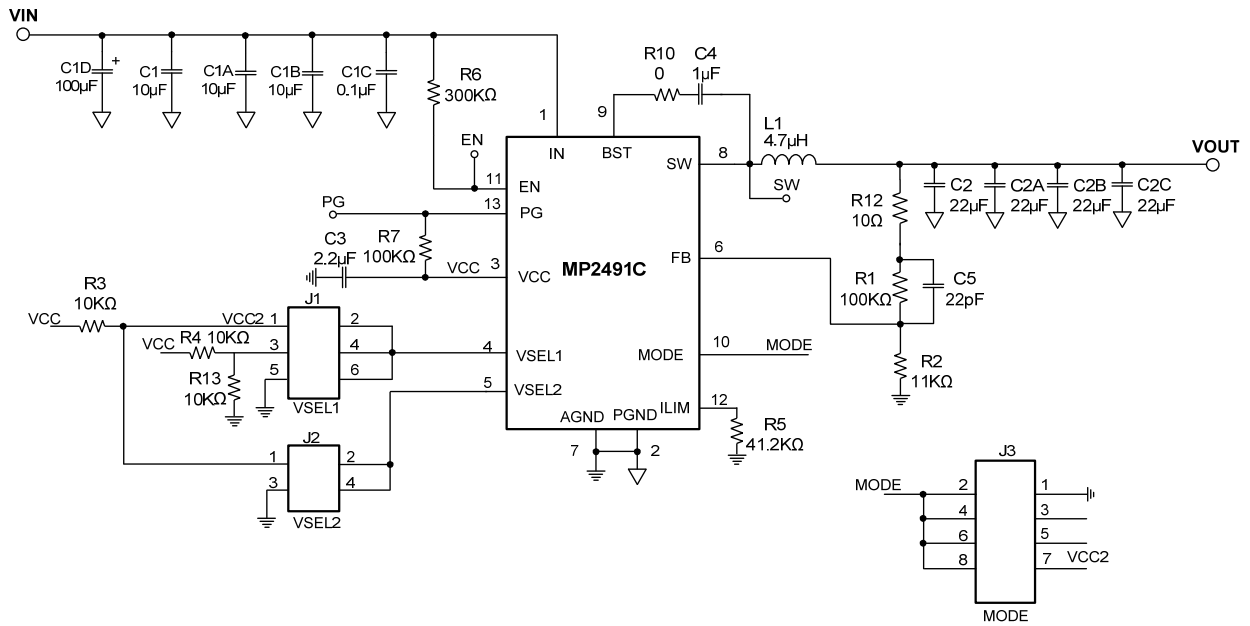
EVALUATION BOARD SCHEMATIC

EV2491C-QB-00A BILL OF MATERIALS

Qty	Ref	Value	Description	Package	Manufacturer	Part Number
3	C1, C1A, C1B	10 μ F	Ceramic Capacitor, 35V,X5R	0805	Murata	GRM21BR61E106KA43L
1	C1C	0.1 μ F	Ceramic Capacitor, 50V,X7R	0603	Murata	GRM188R71H104KA93D
1	C1D	100 μ F	Electrolytic Capacitor, 35V	DIP	Chemi-Con	EMZJ35ADA101MF80G
4	C2, C2A, C2B, C2C	22 μ F	Ceramic Capacitor, 25V,X5R	0805	Murata	GRM21BR61E226ME44L
1	C3	2.2 μ F	Ceramic Capacitor, 10V,X7R	0603	Murata	GRM188R71A225KE15D
1	C4	1 μ F	Ceramic Capacitor, 10V,X7R	0603	Murata	GRM188R71A105KA61D
1	C5	22pF	Ceramic Capacitor, 50V,C0G	0603	Murata	GRM1885C1H220JA01D
2	R1,R7	100k Ω	Film Resistor,1%	0603	YAGEO	RC0603FR-07100KL
1	R2	11k Ω	Film Resistor,1%	0603	YAGEO	RC0603FR-0711KL
3	R3,R4, R13	10k Ω	Film Resistor,1%	0603	YAGEO	RC0603FR-0710KL
1	R5	41.2k Ω	Film Resistor,1%	0603	YAGEO	RC0603FR-0741K2L
1	R6	300k Ω	Film Resistor,1%	0603	YAGEO	RC0603FR-07300KL
1	R10	0 Ω	Film Resistor,1%	0603	YAGEO	RC0603FR-070RL
1	R12	10 Ω	Film Resistor,1%	0603	YAGEO	RC0603JR-0710RL
1	L1	4.7 μ H	Inductor, RDC=7m Ω , Isat=15A	SMD	WE	7443551470
1	U1	MP2491C	Step-down converter	QFN-13 (2.5mmx3mm)	MPS	MP2491CGQB

EVB TEST RESULTS

$V_{IN} = 24V$, $V_{OUT} = 5V$, $F_s = 490kHz$, $L = 4.7\mu H$, PFM Mode, $T_A = +25^\circ C$, unless otherwise noted.

Output Ripple

$V_{IN} = 24V$, $V_{OUT} = 5V$, $I_{OUT} = 0A$

CH1:
V_{out}/AC
50mV/div.
CH2: V_{IN}
20V/div.
CH3: V_{sw}
10V/div.
CH4: I_L
2A/div.

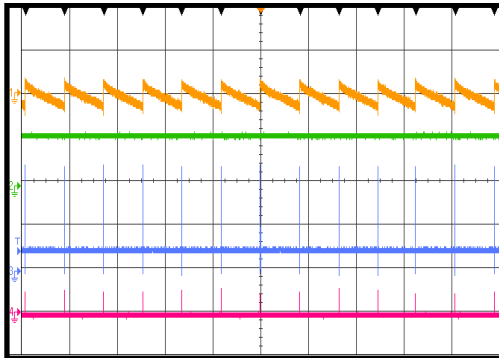

20ms/div.

Output Ripple

$V_{IN} = 24V$, $V_{OUT} = 5V$, $I_{OUT} = 0A$

CH1:
V_{out}/AC
50mV/div.
CH2: V_{IN}
20V/div.
CH3: V_{sw}
10V/div.
CH4: I_L
2A/div.

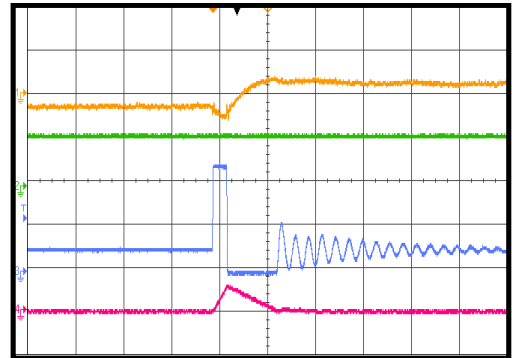

1µs/div.

Output Ripple

$V_{IN} = 24V$, $V_{OUT} = 5V$, $I_{OUT} = 6A$

CH1:
V_{out}/AC
50mV/div.
CH2: V_{IN}
20V/div.
CH3: V_{sw}
10V/div.
CH4: I_L
5A/div.

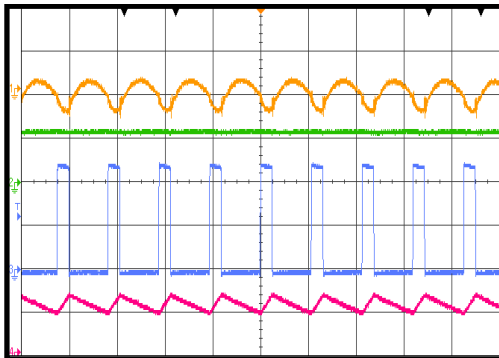

2µs/div.

Power Start-Up

$V_{IN} = 24V$, $V_{OUT} = 5V$, $I_{OUT} = 0A$

CH1: V_{out}
2V/div.
PG
5V/div.
CH2: V_{IN}
20V/div.
CH3: V_{sw}
20V/div.
CH4: I_L
2A/div.

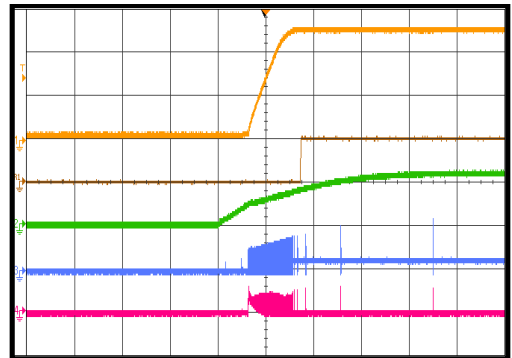

1ms/div.

Power Start-Up

$V_{IN} = 24V$, $V_{OUT} = 5V$, $I_{OUT} = 6A$

CH1: V_{out}
2V/div.
PG
5V/div.
CH2: V_{IN}
20V/div.
CH3: V_{sw}
20V/div.
CH4: I_L
10A/div.

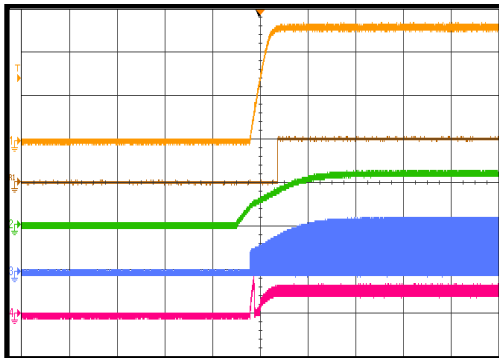

2ms/div.

Power Shutdown

$V_{IN} = 24V$, $V_{OUT} = 5V$, $I_{OUT} = 0A$

CH1: V_{out}
2V/div.
PG
5V/div.
CH2: V_{IN}
20V/div.
CH3: V_{sw}
20V/div.
CH4: I_L
1A/div.

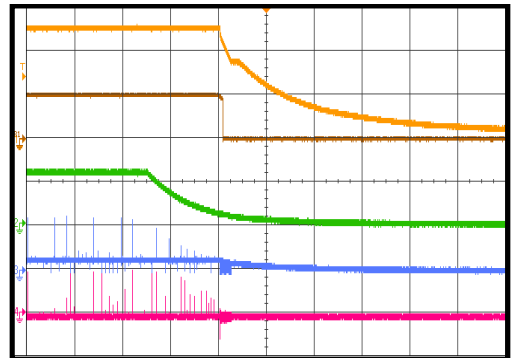

200ms/div.

EVB TEST RESULTS (continued)
 $V_{IN} = 24V$, $V_{OUT} = 5V$, $F_s = 490kHz$, $L = 4.7\mu H$, PFM Mode, $T_A = +25^\circ C$, unless otherwise noted.

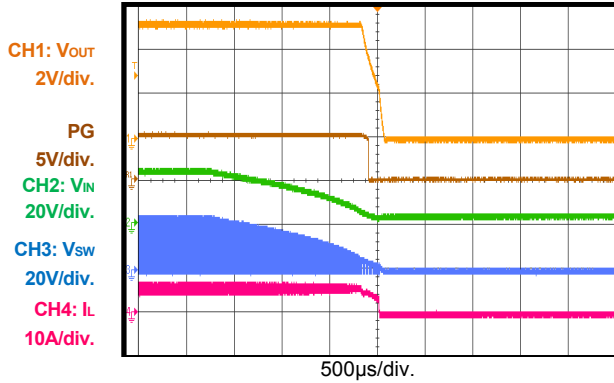
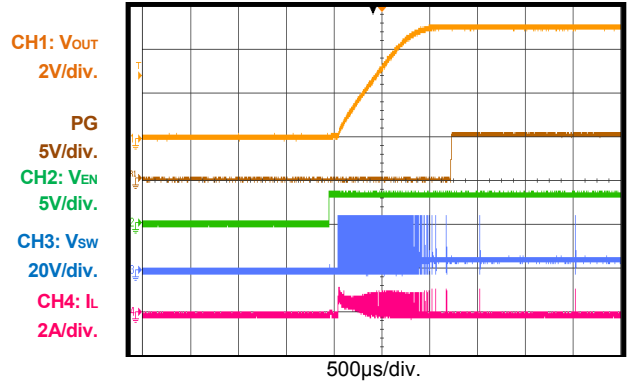
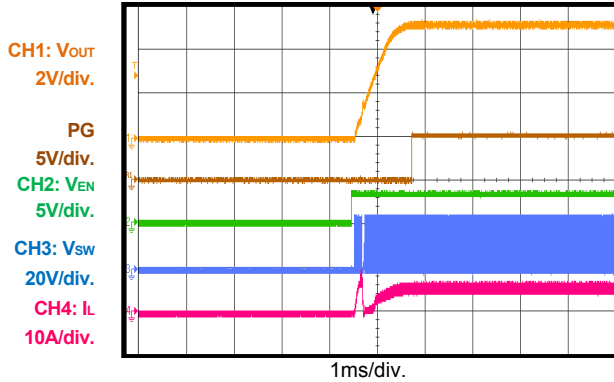
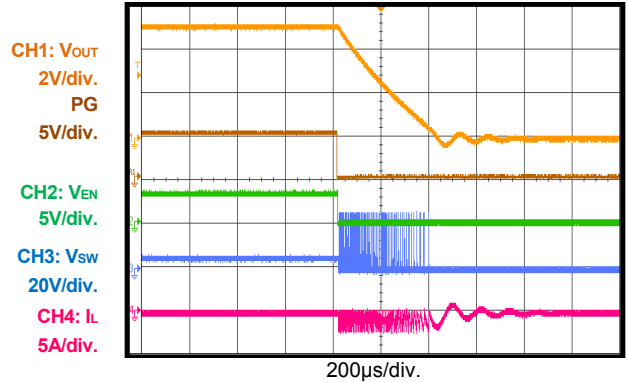
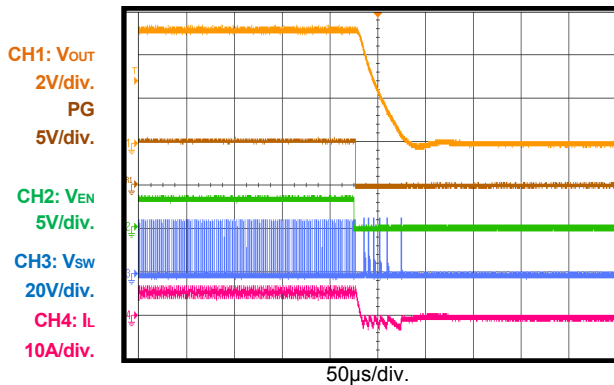
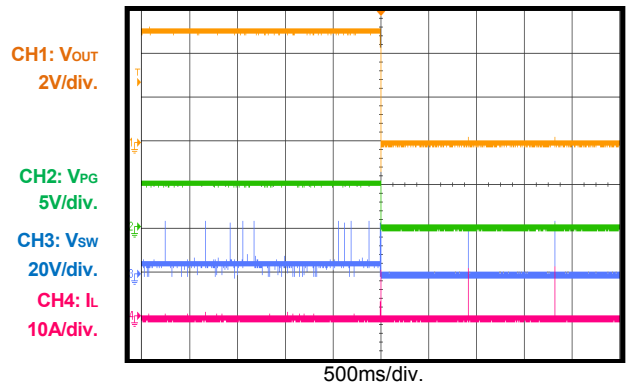
Power Shutdown
 $V_{IN} = 24V$, $V_{OUT} = 5V$, $I_{OUT} = 6A$

EN Start-Up
 $V_{IN} = 24V$, $V_{OUT} = 5V$, $I_{OUT} = 0A$

EN Start-Up
 $V_{IN} = 24V$, $V_{OUT} = 5V$, $I_{OUT} = 6A$

EN Shutdown
 $V_{IN} = 24V$, $V_{OUT} = 5V$, $I_{OUT} = 0A$

EN Shutdown
 $V_{IN} = 24V$, $V_{OUT} = 5V$, $I_{OUT} = 6A$

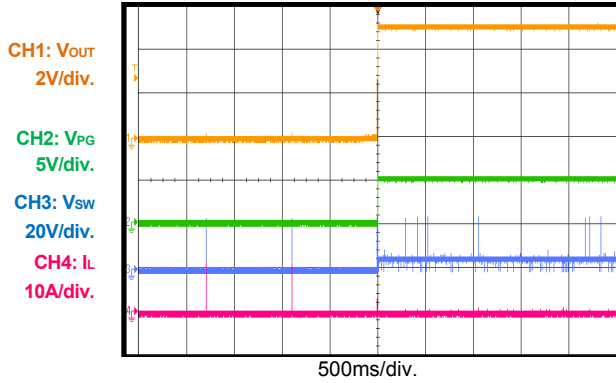
SCP Entry
 $V_{IN} = 24V$, $V_{OUT} = 5V$, $I_{OUT} = 0A$

EVB TEST RESULTS (continued)

$V_{IN} = 24V$, $V_{OUT} = 5V$, $F_s = 490kHz$, $L = 4.7\mu H$, PFM Mode, $T_A = +25^\circ C$, unless otherwise noted.

SCP Recovery

$V_{IN} = 24V$, $V_{OUT} = 5V$, $I_{OUT} = 0A$



Output Voltage Scaling Up

$V_{IN} = 24V$, $I_{OUT} = 0A$, $V_{OUT} = 5 - 9V$

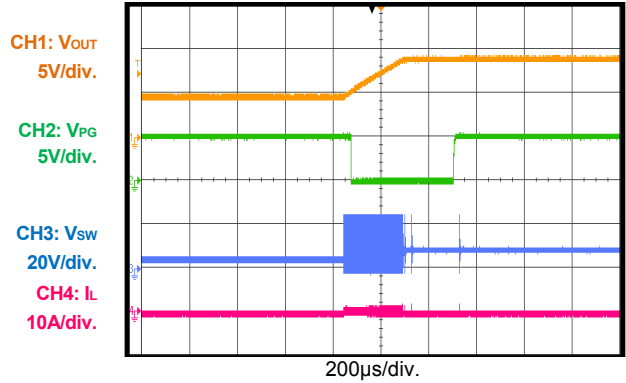

Output Voltage Scaling Down

$V_{IN} = 24V$, $I_{OUT} = 0A$, $V_{OUT} = 9 - 5V$

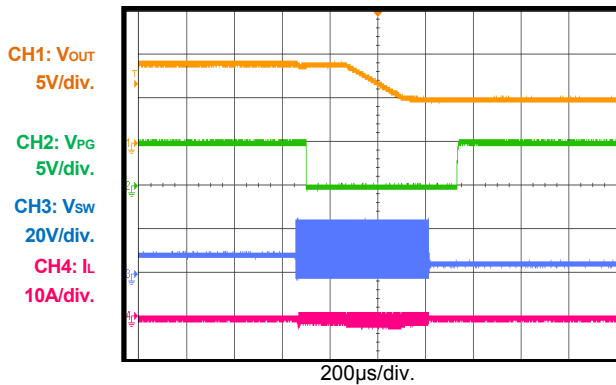

Output Over-Voltage Protection

$V_{IN} = 24V$, $I_{OUT} = 0A$, add external DC voltage to output

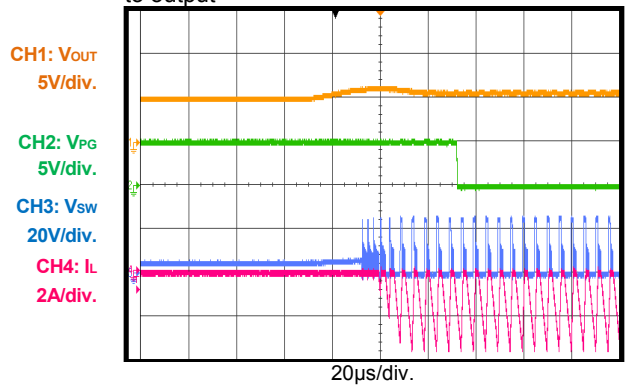

Load Transient

$V_{IN} = 24V$, $V_{FB} = 1.2V$, $V_{OUT} = 5V$, $I_{OUT} = 0 - 3A$, $800mA/\mu s$

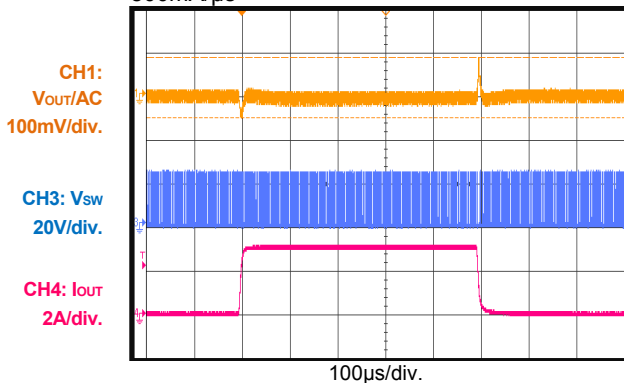

Load Transient

$V_{IN} = 24V$, $V_{FB} = 1.2V$, $V_{OUT} = 5V$, $I_{OUT} = 0 - 6A$, $800mA/\mu s$

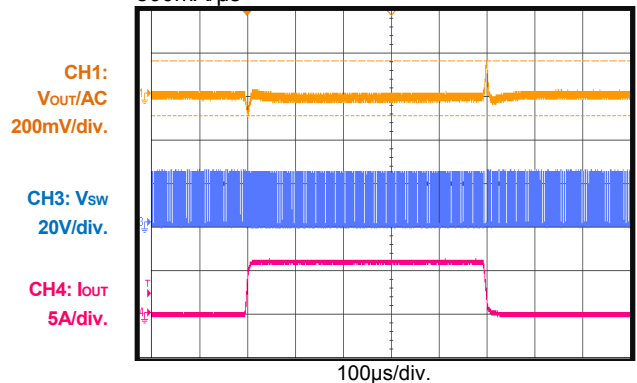

PRINTED CIRCUIT BOARD LAYOUT

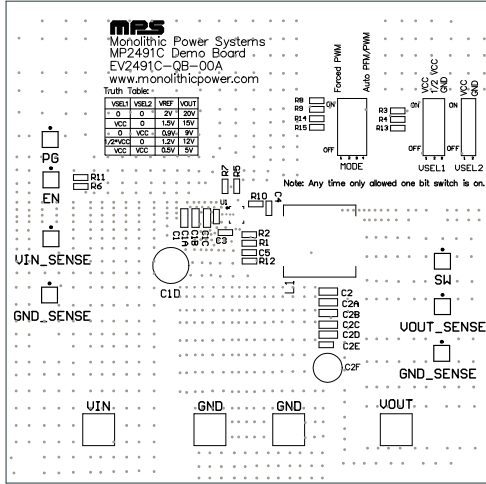

Figure 1: Top Silk Layer

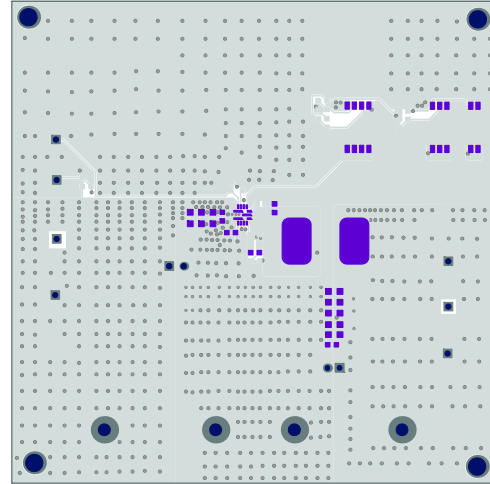

Figure 2: Top Layer

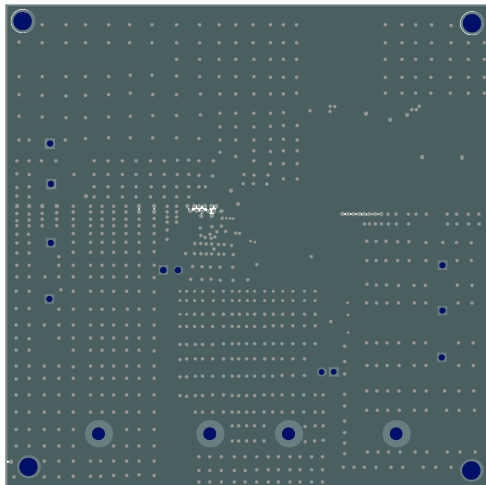

Figure 3: Middle1 Layer

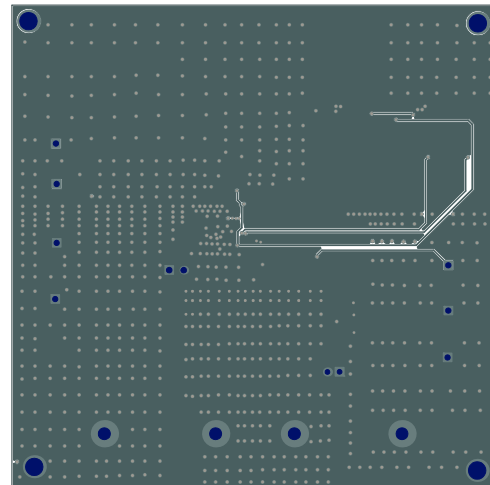

Figure 4: Middle2 Layer

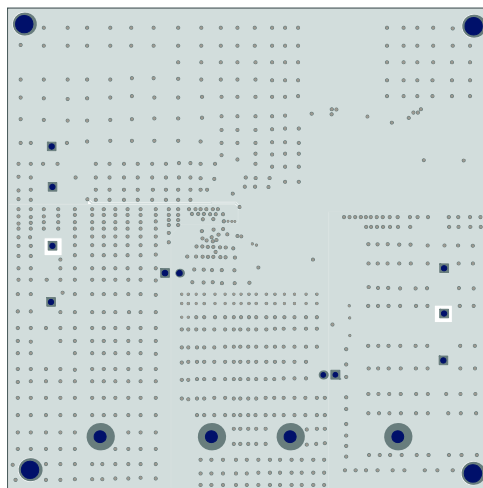

Figure 5: Bottom Layer

QUICK START GUIDE

1. Preset Power Supply to 24V, then turn off the power supply and connect to the VIN and GND pins.
2. Connect the positive and negative terminals of the load to the VOUT and GND pins, respectively.
3. The Vout can be set by VSEL1 and VSEL2 switch, the truth table is shown as below. The default Vout is set to 5V.

VSEL1	VSEL2	V _{REF}	V _{OUT}
0	0	2V	20V
VCC	0	1.5V	15V
0	VCC	0.9V	9V
1/2*VCC	0	1.2V	12V
VCC	VCC	0.5V	5V

4. The buck operation mode can be set by MODE switch, the truth table is shown as below. The default MODE is set to PFM mode.

Pin voltage	Buck Operation Mode
0	Forced PWM
VCC	Auto PFM/PWM

5. Turn the power supply on, the board will automatically start up.

NOTICE: The information in this document is subject to change without notice. Users should warrant and guarantee that third party Intellectual Property rights are not infringed upon when integrating MPS products into any application. MPS will not assume any legal responsibility for any said applications.