

## DESCRIPTION

The EV2497DN-00A is an evaluation board for the MP2497. The MP2497 is a monolithic step-down switch mode converter with a programmable output current limit. It achieves 3A continuous output current over a wide input supply range with excellent load and line regulation. An internal 2~4ms soft start prevents inrush current at turning on. And it is capable of providing output line drop compensation.

MP2497 achieves low EMI signature with well controlled switching edges.

Fault condition protection includes hiccup current limit and short circuit protection, programmable output over voltage protection and thermal shutdown.

The MP2497 requires a minimum number of readily available standard external components.

## ELECTRICAL SPECIFICATIONS

Parameter	Symbol	Value	Units
Input Voltage	$V_{IN}$	8 - 50	V
Output Voltage	$V_{OUT}$	5	V
Output Current Limit	$I_{OUT-L}$	3	A
Output OVP	$V_{OVP}$	6	V

## FEATURES

- Wide 8V to 50V Operating Input Range
- Programmable up to 3A Output Current
- Programmable Output Over Voltage Protection
- Internal 4ms Soft Start
- Stable with Low ESR Output Ceramic Capacitors
- Fixed 100kHz Frequency
- Low EMI Signature
- Thermal Shutdown
- Output Line Drop Compensation
- Hiccup Circuit Limit and Short Circuit Protection

## APPLICATIONS

- USB Power Supplies
- Automotive Cigarette Lighter Adapters
- Power Supply for Linear Chargers

For MPS green status, please visit MPS website under Quality Assurance. MPS<sup>®</sup> and "The Future of Analog IC Technology" are Registered Trademarks of Monolithic Power Systems, Inc.

## EV2497DN-00A EVALUATION BOARD



(L x W x H) 2.5" x 2.5" x 0.4"  
(6.35cm x 6.35cm x 1cm)

Board Number	MPS IC Number
EV2497DN-00A	MP2497

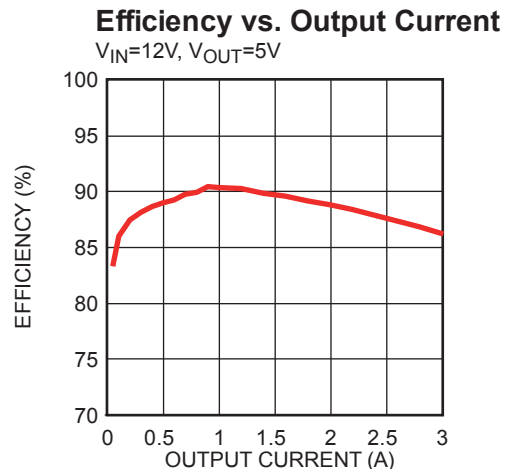

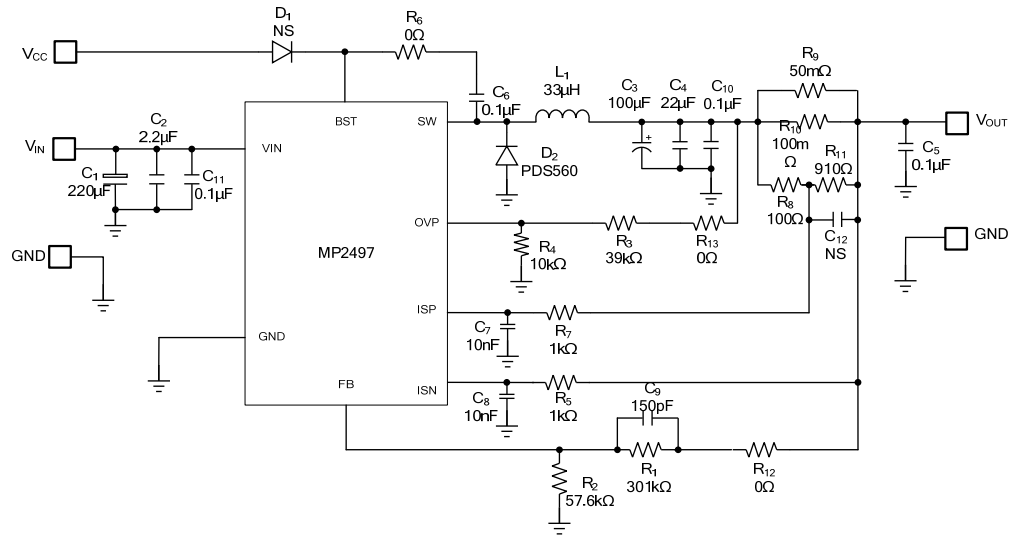
**EVALUATION BOARD SCHEMATIC**

**EV2497DN-00A BILL OF MATERIALS**

Qty	RefDes	Value	Description	Package	Manufacturer	Manufacturer P/N
1	C1	220µF	Electronic Cap., 63V	DIP	Rubycon	220uF/63V
1	C2	2.2µF	Ceramic Cap., 100V, X7R	1210	muRata	GRM32ER72A225KA35L
1	C3	100µF	Electronic Cap., 16V	SMD	Sanyo	16SVPC100MV
1	C4	22µF	Ceramic Cap., 16V, X7R	1210	muRata	GRM32ER71C226KE18L
3	C5, C6, C10	100nF	Ceramic Cap., 50V, X7R	0603	muRata	GRM188R71H104KA93D
2	C7, C8	10nF	Ceramic Cap., 50V, X7R	0603	TDK	C1608X7R1H103K
1	C9	150pF	Ceramic Cap., 50V, X7R	0603	TDK	C1608C0G1H151J
1	C11	0.1µF	Ceramic Cap., 100V, X7R	0603	muRata	GRM188R72A104KA35D
0	C12	NS	Do Not Stuff			
0	D1	NS	Do Not Stuff			
1	D2	5A,60V	Diode	PowerDI TM5	Diodes	PDS560
1	L1	33µH	Inductor, 5.5A/45mΩ	SMD	SMD	7447709330
1	R1	301kΩ	Film Res., 1%	0603	Yageo	RC0603FR-07301KL
1	R2	57.6kΩ	Film Res., 1%	0603	Yageo	RC0603FR-0757K6L
1	R3	39kΩ	Film Res., 1%	0603	Yageo	RC0603FR-0739KL
1	R4	10kΩ	Film Res., 1%	0603	Yageo	RC0603FR-0710KL
2	R5, R7	1kΩ	Film Res., 1%	0603	Royalohm	0603F1001T5E
1	R8	100Ω	Film Res., 1%	0603	Yageo	RC0603FR-07100RL
1	R11	910Ω	Film Res., 1%	0603	Yageo	RC0603FR-07910RL
3	R6, R12, R13	0Ω	Film Res., 5%	0603	Royalohm	0603J0000T5E
1	R9	50mΩ	Sense Res., 1%	2512	CYNTEC	RL3264-6-R050-FN
1	R10	100mΩ	Sense Res., 1%	2512	CYNTEC	RL3264-6-R0100-FN
1	U1		DC-DC Converter	SOIC8E	MPS	MP2497DN

### EVB TEST RESULTS

C1=220μF, C2=2.2μF, C3=100μF, C4=22μF, L=33μH, R<sub>SENSE</sub>=R<sub>9</sub>//R<sub>10</sub>=33mΩ, R<sub>8</sub>=100Ω, R<sub>11</sub>=910Ω, T<sub>A</sub>=25°C, unless otherwise noted.

**Output Line Drop Compensation**

R<sub>SENSE</sub>=25mΩ, R<sub>TRACE</sub>=120mΩ  
R<sub>1</sub>=301kΩ

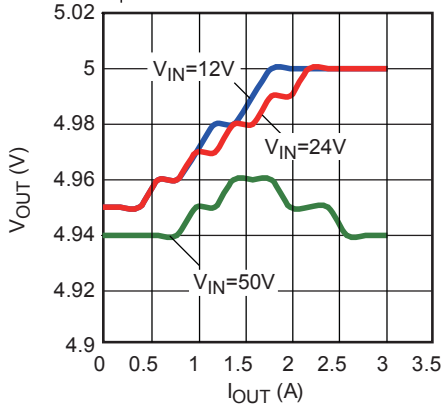

**Loop Gain with Phase Margin**

V<sub>IN</sub>=12V, V<sub>OUT</sub>=5V, I<sub>OUT</sub>=3A  
Resistor Load

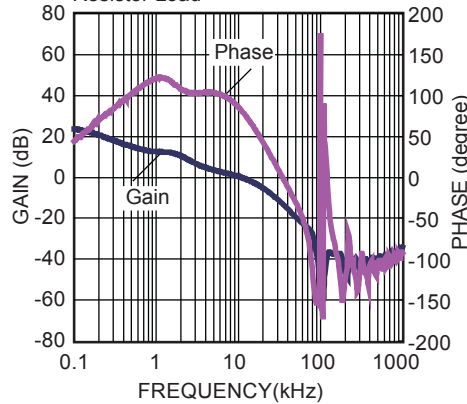

**Efficiency vs. Output Current**

V<sub>OUT</sub>=5V

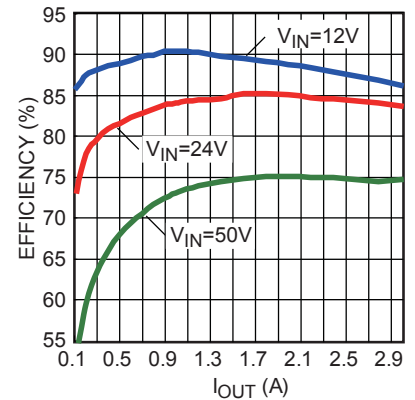

**Load Regulation**

Connect ISP, ISN to GND

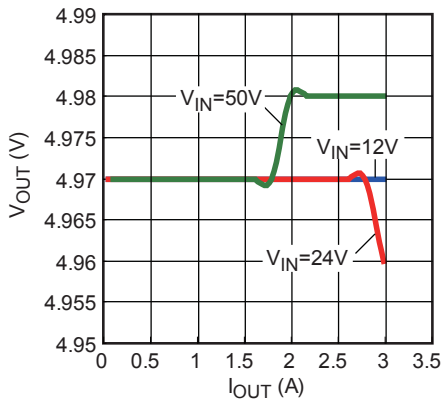

**V<sub>FB</sub> vs. Temperature**

V<sub>IN</sub>=12V

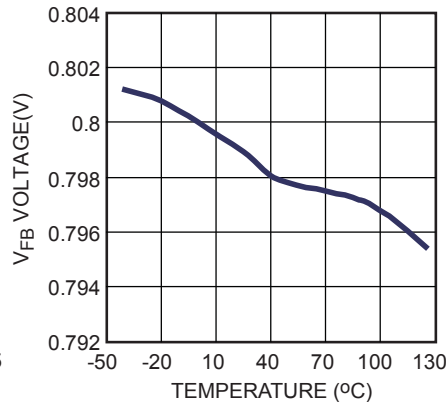

**EMI Radiation**

V<sub>IN</sub>=12V, V<sub>OUT</sub>=5V, I<sub>OUT</sub>=3A  
Resistor Load

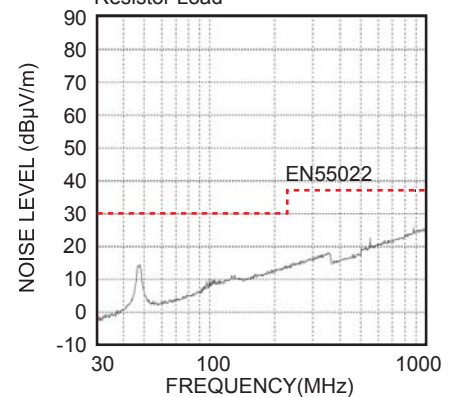

**EVB TEST RESULTS (Continued)**

**C1=220μF, C2=2.2μF, C3=100μF, C4=22μF, L=33μH, R<sub>SENSE</sub>=R9//R10=33mΩ, R8=100Ω, R11=910Ω, T<sub>A</sub>=25°C, unless otherwise noted.**

**Steady State**

V<sub>IN</sub>=12V, V<sub>OUT</sub>=5V, I<sub>OUT</sub>=3A  
E-Load

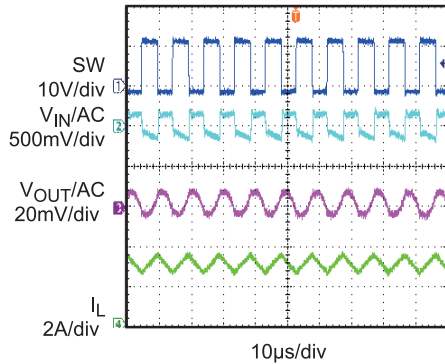

**Steady State**

V<sub>IN</sub>=50V, V<sub>OUT</sub>=5V, I<sub>OUT</sub>=3A  
E-Load

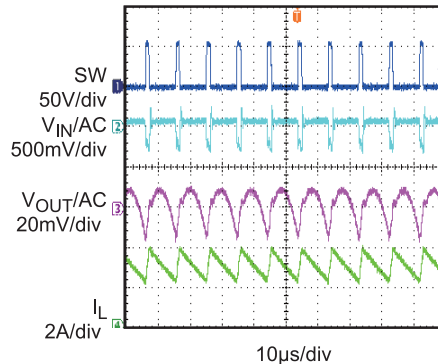

**Power Ramp Up**

V<sub>IN</sub>=12V, V<sub>OUT</sub>=5V, I<sub>OUT</sub>=3A  
Resistor Load

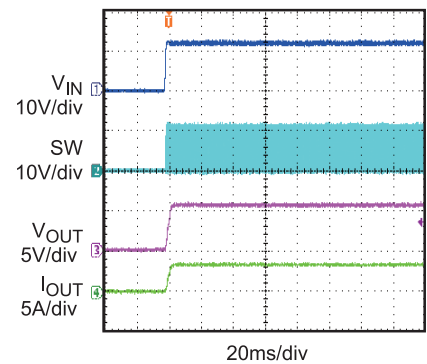

**Power Ramp Down**

V<sub>IN</sub>=12V, V<sub>OUT</sub>=5V, I<sub>OUT</sub>=3A  
Resistor Load

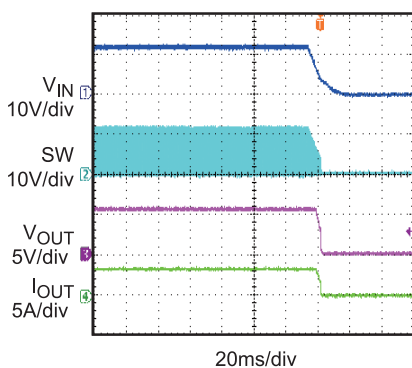

**Short Circuit Enter**

V<sub>IN</sub>=12V, V<sub>OUT</sub>=5V, I<sub>OUT</sub>=0.5A  
E-Load

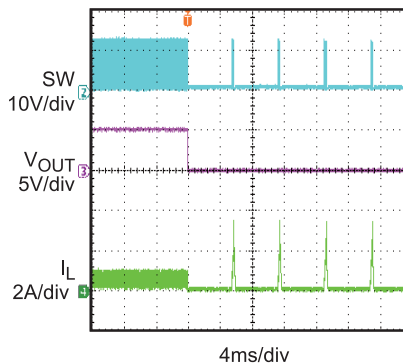

**Short Circuit Steady**

V<sub>IN</sub>=12V, V<sub>OUT</sub>=5V  
E-Load

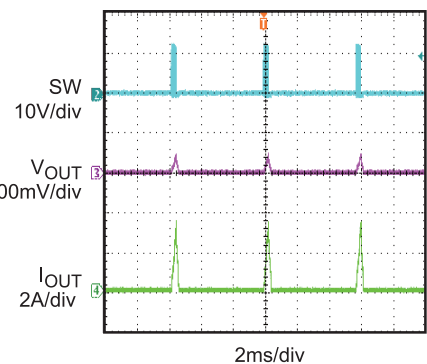

**Short Circuit Recovery**

V<sub>IN</sub>=12V, V<sub>OUT</sub>=5V, I<sub>OUT</sub>=0.5A  
E-Load

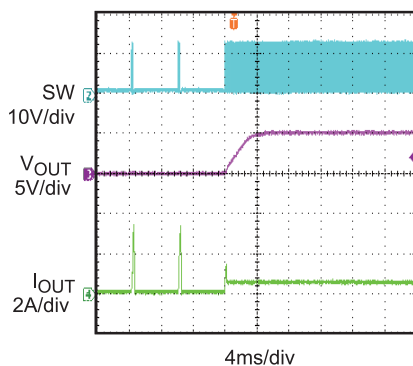

**Load Transient Response**

V<sub>IN</sub>=12V, V<sub>OUT</sub>=5V, I<sub>OUT</sub>=0.3A-3A  
Slew Rate=6.4mA/μs

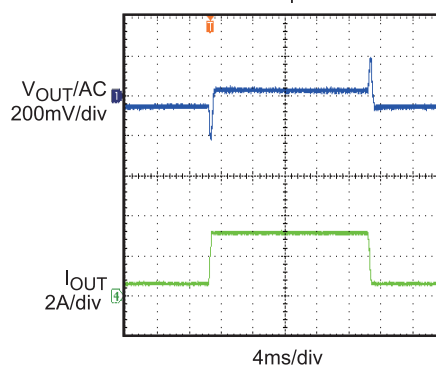

**Over Voltage Protection**

V<sub>IN</sub>=12V, V<sub>OUT</sub>=5V, I<sub>OUT</sub>=3A  
Add an External Power to OVP

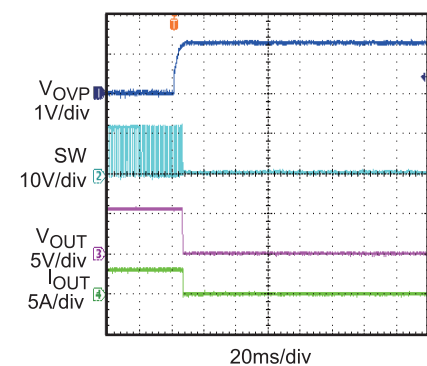

**PRINTED CIRCUIT BOARD LAYOUT**

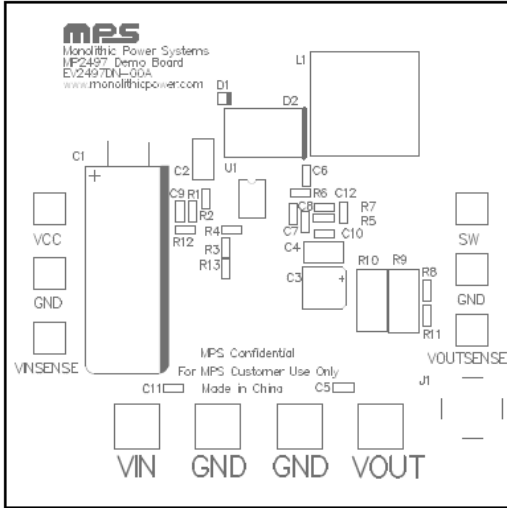

**Figure 1—Top Silk Layer**

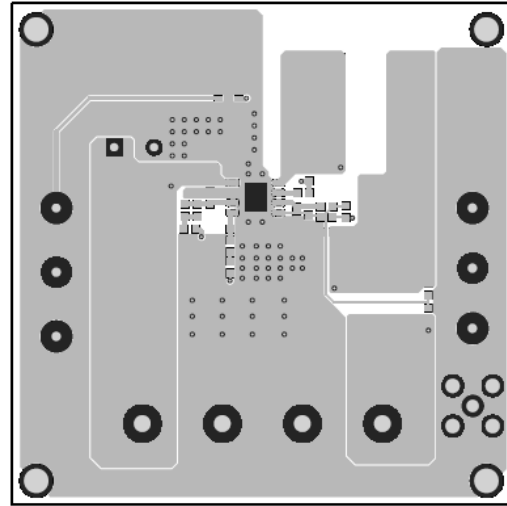

**Figure 2—Top Layer**

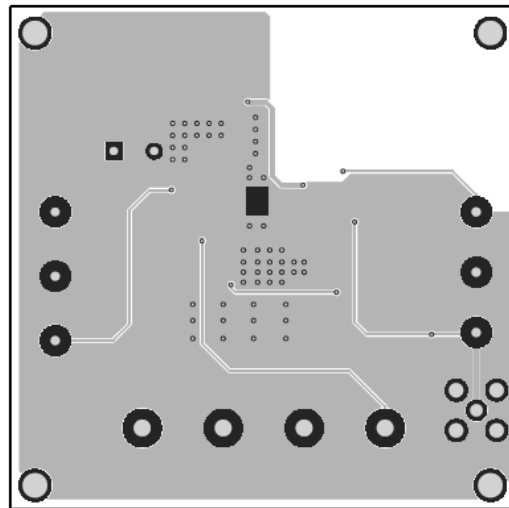

**Figure 3—Bottom Layer**

## QUICK START GUIDE

1. The output voltage of this board is set to 5V. The board layout accommodates most commonly used inductors and output capacitors.
2. Attach the positive and negative ends of the load to the VOUT and GND pins, respectively.
3. Attach the input voltage ( $8V \leq V_{IN} \leq 50V$ ) and input ground to the VIN and GND pins, respectively.
4. The output current limit is set as:

$$I_{OUT\_L} = \frac{100mV}{R_{SENSE}} \times \frac{R8 + R11}{R11} \quad (R_{SENSE} = R9 // R10)$$

5. The output line compensation is set via R1

$$R1 = \frac{R_{TRACE} \times 400k\Omega}{6 \times R_{SENSE}} \times \frac{R8 + R11}{R11}$$

Where, the  $R_{TRACE}$  is the resistance of the output line.

6. The output voltage  $V_{OUT}$  can be set by R2. The formula is:

$$R2 = R1 \times \frac{V_{FB}}{V_{OUT} - V_{FB}}$$

Where  $V_{FB} = 0.8V$

For example, for  $V_{OUT} = 5V$ ,  $R1 = 301k\Omega$ :

$$R2 = R1 \times \frac{V_{FB}}{V_{OUT} - V_{FB}} = 301k\Omega \times \frac{0.8V}{5V - 0.8V} = 57.6k\Omega$$

For the closest standard 1% value.

7. The short circuit current limit is set as:

$$I_{OUT\_SL} = \frac{100mV - 6.2\mu A \times R7}{R_{SENSE}} \times \frac{R8 + R11}{R11}$$

8. RC filter connected to ISN and ISP pin is better to be set as  $RC \geq 10^{-5}s$ , and it should meet

$$R7 + \frac{R8 \times R11}{R8 + R11} = R5, \quad C7 = C8$$

9. When the OVP pin voltage is higher than 1.23V, the part will shutdown. The R3 is set as:

$$R3 = \frac{(V_{OUT} - 1.23V) \times R4}{1.23V}$$

**NOTICE:** The information in this document is subject to change without notice. Users should warrant and guarantee that third party Intellectual Property rights are not infringed upon when integrating MPS products into any application. MPS will not assume any legal responsibility for any said applications.