

DESCRIPTION

The EV2660-C-00A is an evaluation board for the MP2660, a highly-integrated single-cell Li-Ion/Li-Polymer battery charger with system power path management, targeted at space limited portable applications. It takes input power from either an AC adapter or a USB port to supply the system load and charge the battery independently. The charger section features trickle charge, constant current (CC) and constant voltage (CV) regulation, charge termination and charge status.

EV2660 ensures the continuous power to the system by automatically selecting the input, the battery or both to power the system.

EV2660 provides system short circuit protection to prevent the Li-Ion battery from being damaged due to excessive high current.

EV2660 cuts off the path between battery and system when battery UVLO to prevent the Li-Ion battery from being overly discharged.

Through the I2C connector on EV2660, the customer can program the charging parameters, such as: input current limit, input voltage regulation limit, charging current, battery regulation voltage, and battery UVLO.

ELECTRICAL SPECIFICATION

Parameter	Symbol	Value	Units
Input Voltage	V _{IN}	4.35 - 5.5	V
Battery Voltage	V _{BATT}	3.60 - 4.545	V
Input Current Limit	I _{IN} Limit	85 - 455	mA
V _{IN} Regulation Voltage	V _{IN} Limit	V _{BATT} +400mV	V
Charge Current	I _{CHG}	8 - 535	mA
Discharge Current Limit	I _{BATT_MAX}	100 - 1600	mA

Features

- Fully Autonomous Charger for Single-Cell Li-Ion/Polymer Batteries
- Current Limit for USB Port
- Complete Power Path Management for Simultaneously Powering the System and Charging the Battery
- 0.5% Charging Voltage Accuracy
- 12V Maximum Voltage for the Input Source
- I²C Interface for Setting charging Parameters and Status Reporting
- Robust Charging Protection Including Battery Temperature Monitor
- Battery Disconnection Function

APPLICATIONS

- Wearable devices
- Smart Handheld Devices
- Fitness Accessories
- Smart Watches

All MPS parts are lead-free, halogen free, and adhere to the RoHS directive. For MPS green status, please visit MPS website under Quality Assurance.

"MPS" and "The Future of Analog IC Technology" are Registered Trademarks of Monolithic Power Systems, Inc.

EV2660-C-00A EVALUATION BOARD



(L x W x H) 2.5" x 2.5" x 0.063"
(6.35cm x 6.35cm x 0.16cm)

Board Number	MPS IC Number
EV2660-C-00A	MP2660

EVALUATION BOARD SCHEMATIC

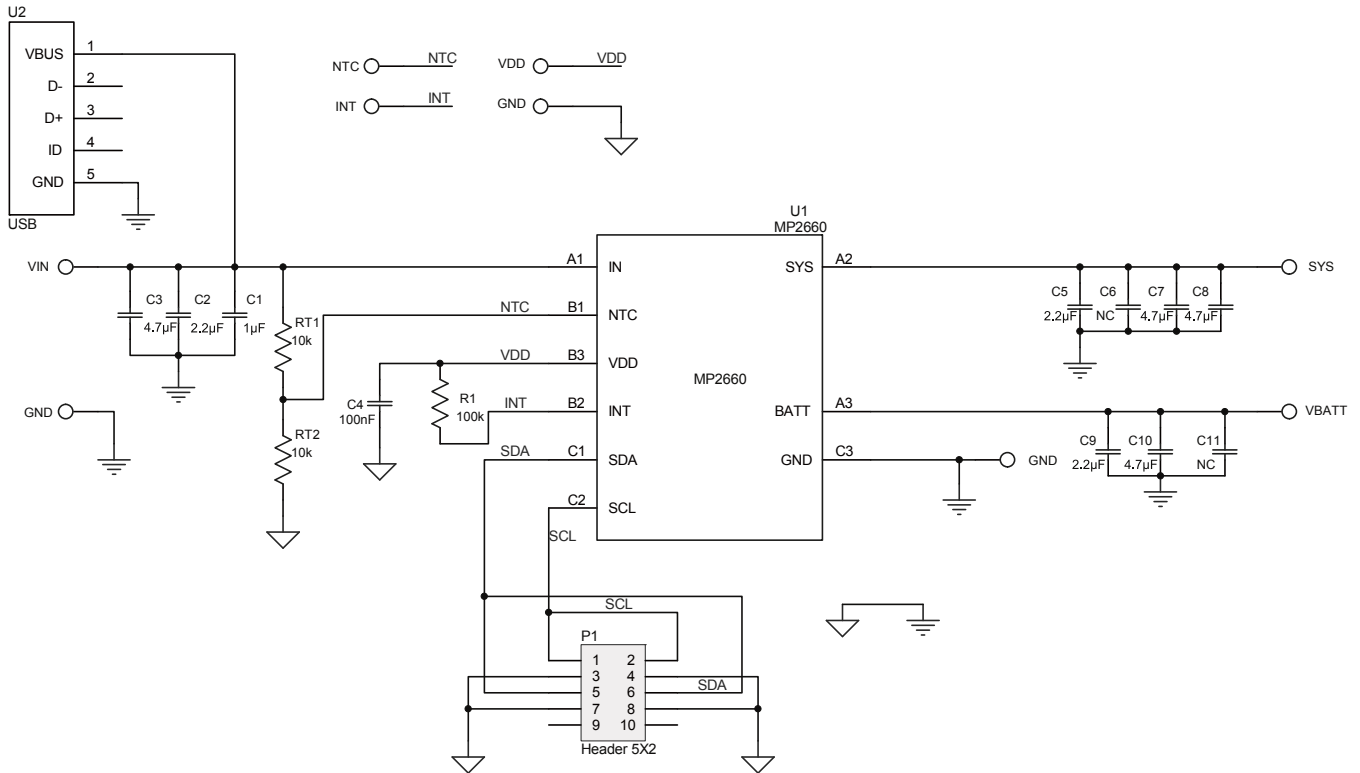

EV2660-C-00A BILL OF MATERIALS

Qty	Ref	Value	Description	Package	Manufacture	Manufacture_PN
1	C1	1µF	Ceramic Cap; 25V;X7R;0603;	0603	muRata	GRM188R71E105KA12D
3	C2, C5, C9	2.2µF	Ceramic Cap; 25V;X7R;0805;	0805	muRata	GRM21BR71E225KA73L
4	C3, C7, C8, C10	4.7µF	Ceramic Cap;25V;X7R;1206	1206	muRata	GRM31CR71E475KA88L
1	C4	100nF	Ceramic Cap; 25V;X7R;0805;	0805	HHEC	C0805X104K025T
1	C6	NC	Ceramic Cap; 25V;X7R;0805;	0805	muRata	GRM21BR71E225KA73L
1	C11	NC	Ceramic Cap;25V;X7R;1206	1206	muRata	GRM31CR71E475KA88L
1	P1		Header, 5-Pin, Dual row			
1	R1	100k	Film Resistor;1%;	0603	Yageo	RC0603FR-07100KL
2	RT1, RT2	10k	Film Resistor;1%;	0603	Yageo	RC0603FR-0710KL
1	U2		Micro-B USB connector;			
1	U1	IC		WCSP 1.55mm*1 .55mm	MPS	MP2660

PRINTED CIRCUIT BOARD LAYOUT

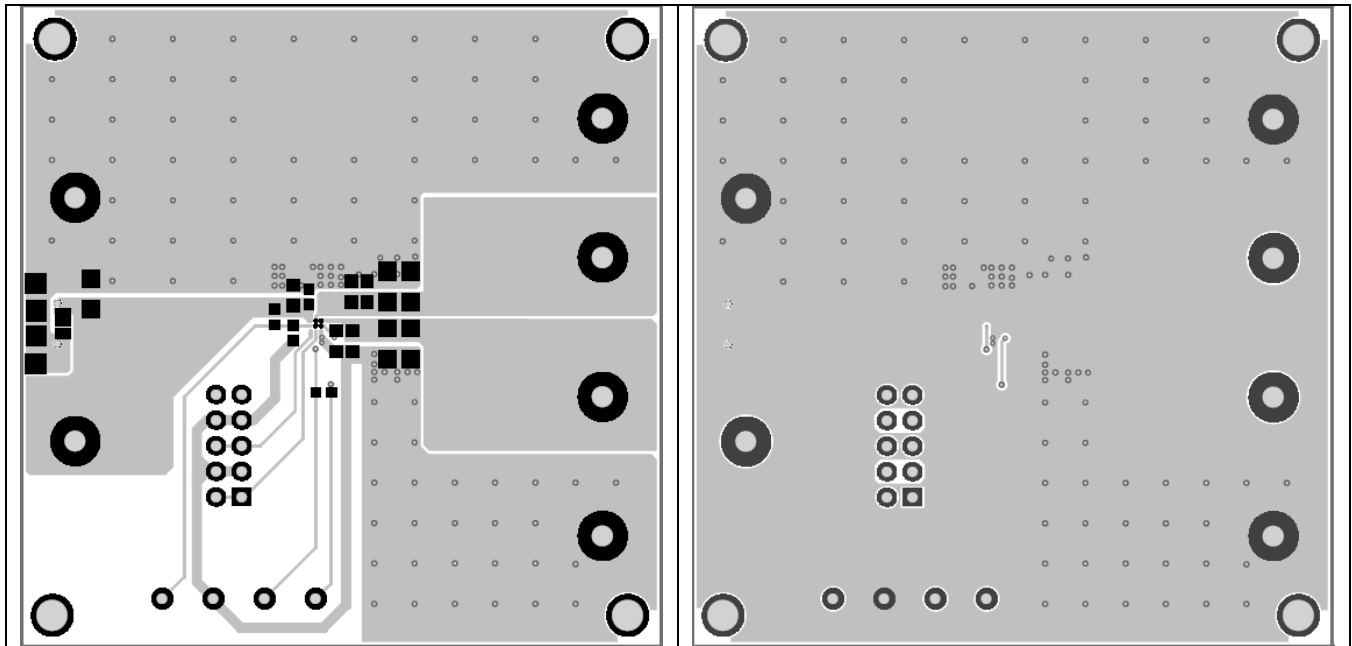

Figure1 Top Layer

Figure2 Bottom Layer

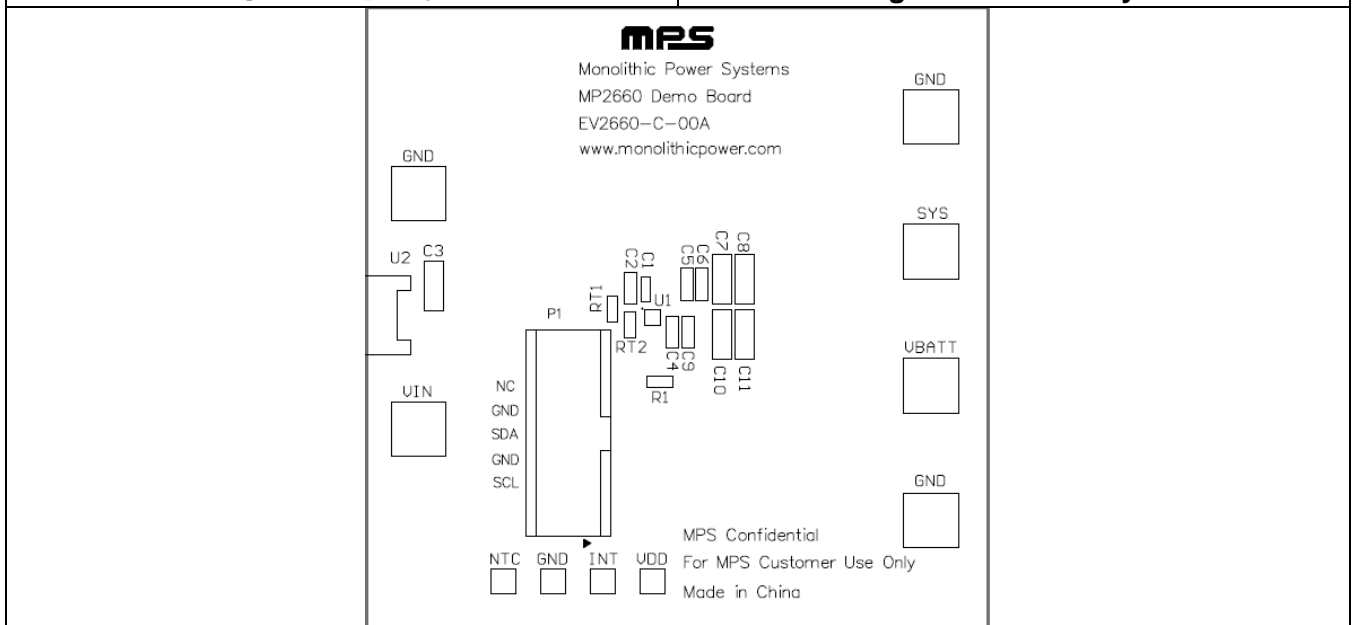

Figure3 Top Silk Layer

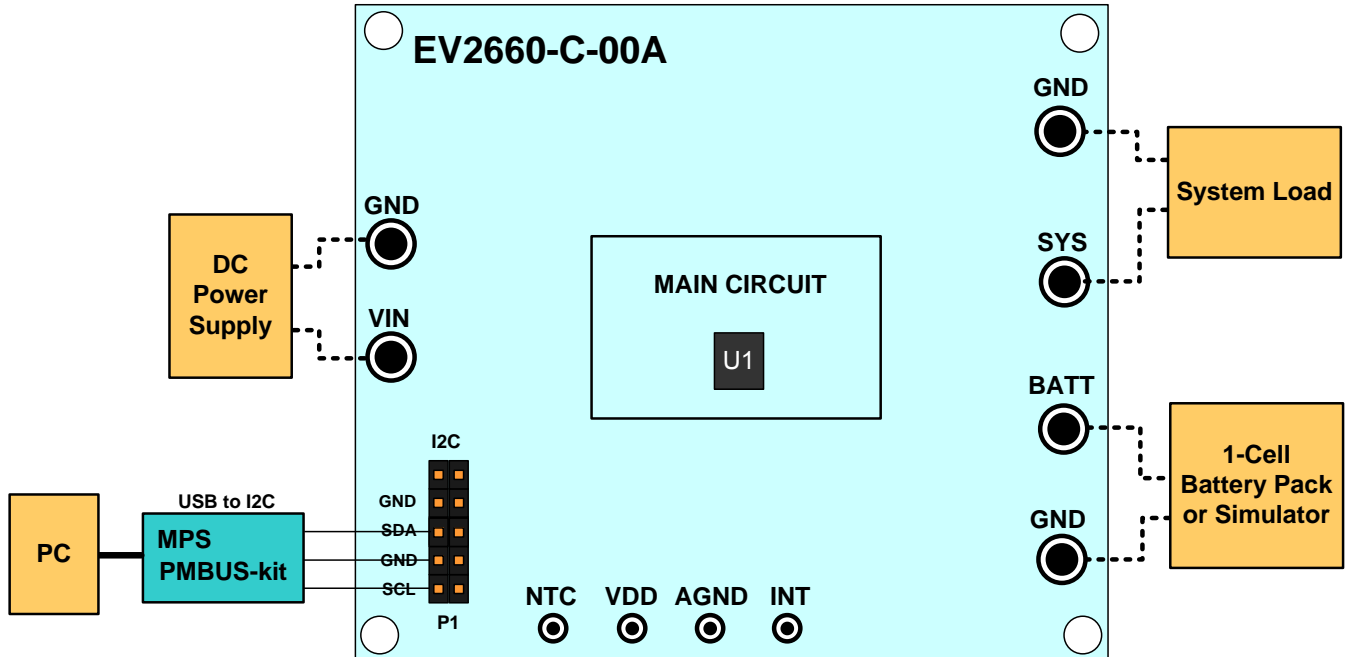

Figure 5 Test Setup for MP2660

5) Turn on the computer. Launch the MP2660 evaluation software. The main window of the software is shown in Figure 6.

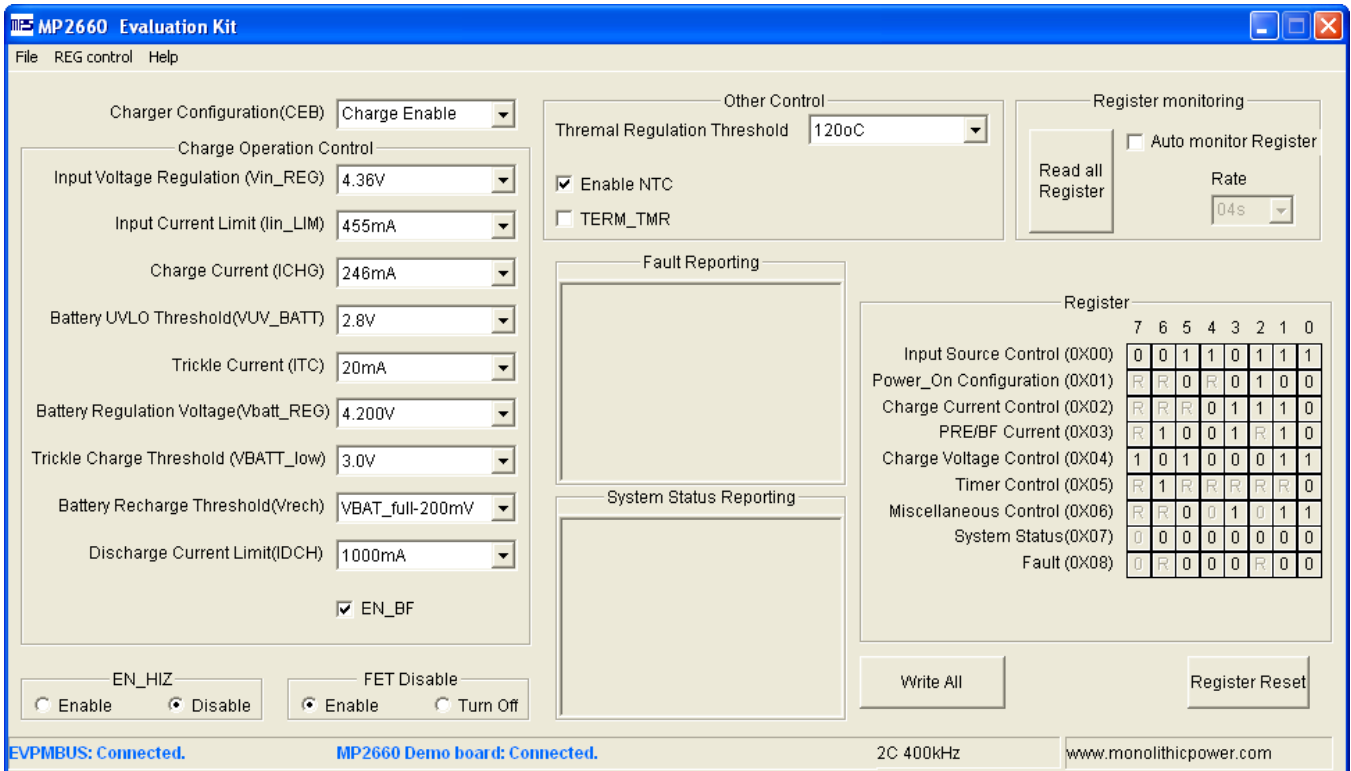
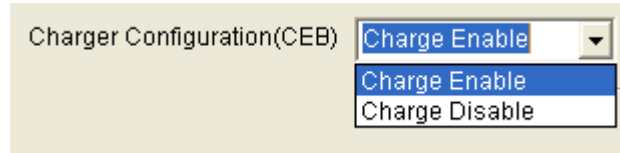

Figure 6 MP2660 evaluation software

Procedure

Make sure all the connections are normal -- the EVPMBUS connected and EV2660-C-00A connected. It is ready to run the program!

1 Select the operation mode of MP2660:



2 Charger Function

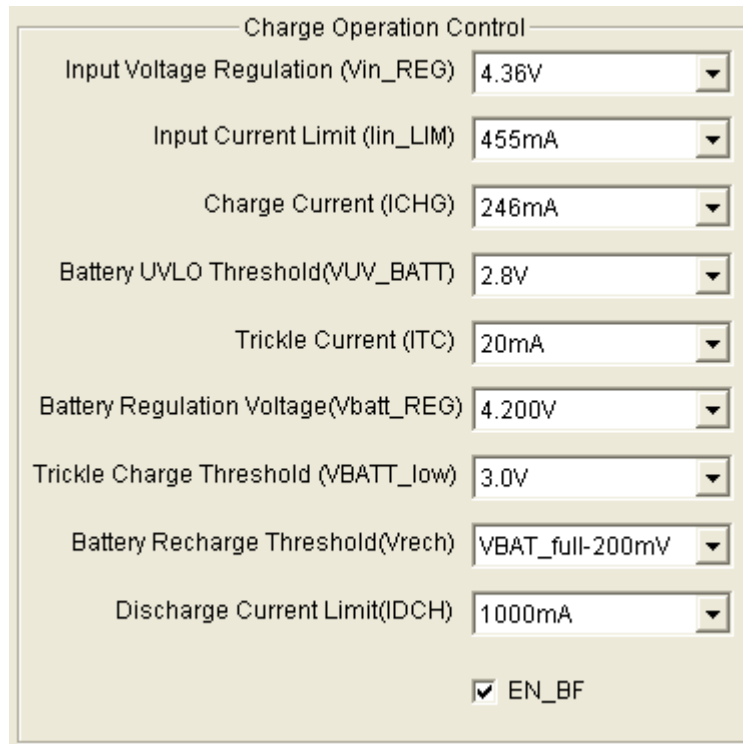

2.1. Set Input Voltage Regulation at 4.68 V (the range is 3.88 - 5.08V, which is recommended 400mV higher than the Charge Full Voltage)

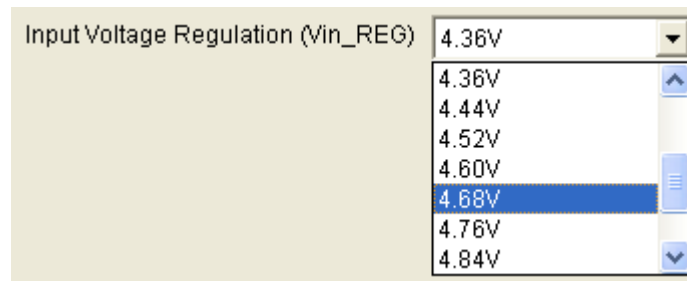

2.2. Set Input Current Limit to 455 mA (the range is 85 – 455mA)

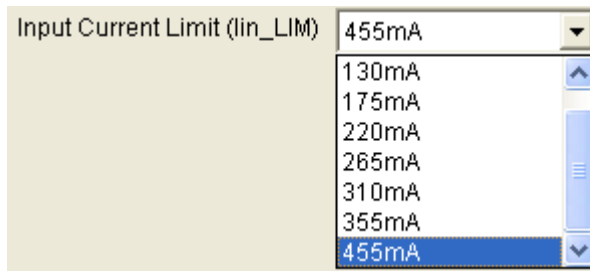

The input current limit can be set to be a little bit lower than the max current rating of the input source. When input current hits the limit the charge current will be decreased to keep the input current constant at this limit, in order to power the system firstly.

2.3. Set Constant Charge Current, ICHG to 246 mA (the range is 8 – 535mA)

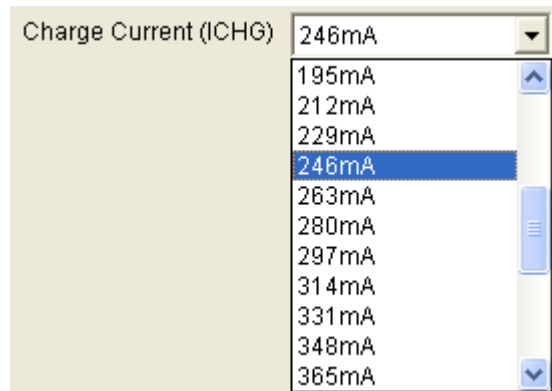

2.4. Set BATT UVLO threshold to 2.8V (the range is 2.4 – 3.1V)

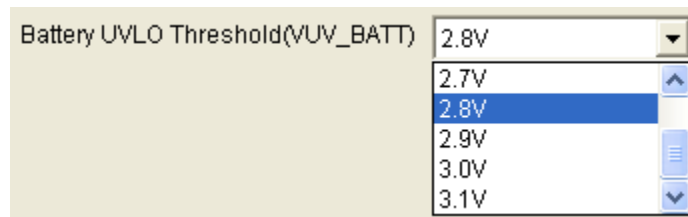

2.5. Set Trickle Current to 20 mA (the range is 6 – 27mA)

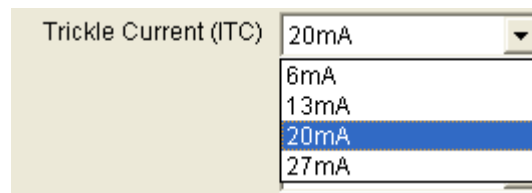

2.6. Set Charge Full Voltage to 4.200 V (the range is 3.600 - 4.545V)

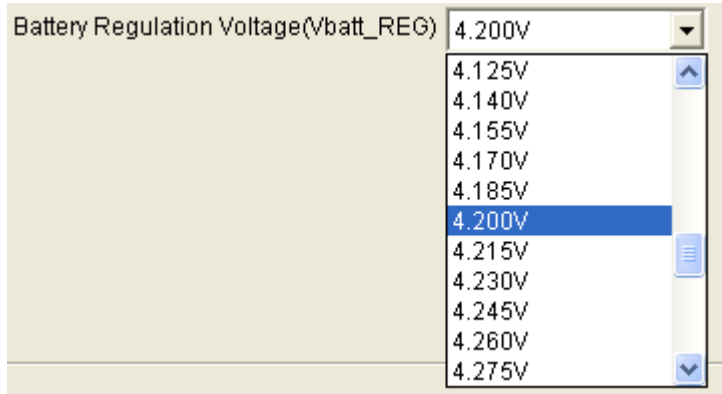

2.7. Set Trickle - Charge to CC Charge Threshold Voltage to 3.0 V (the range is 2.8 – 3.0V)

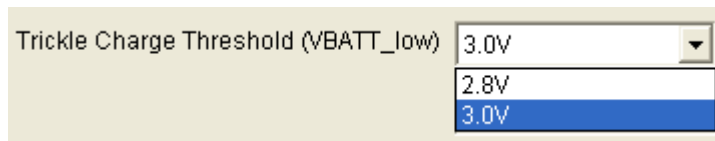

2.8. Set Battery auto recharge Voltage to VBATT_Full – 200mV (the range is 100mV or 200mV)

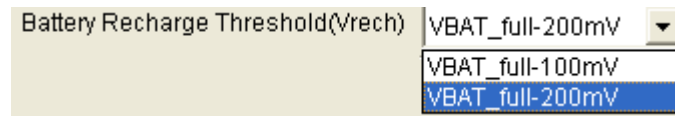

2.9. Set battery discharge current limit to 1000mA (the range is 100mA to 1600mA):

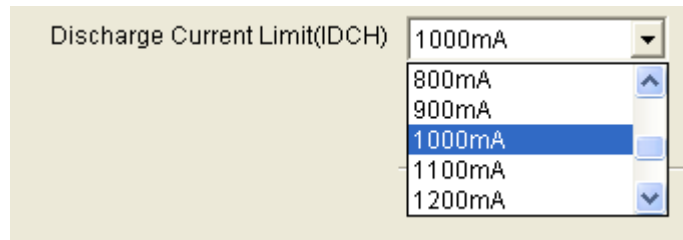

2.10. Termination Function Select

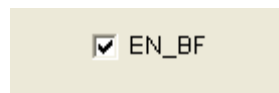

3. Others

3.1. LDO FET Control:

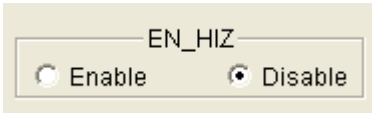

EN_HIZ

Enable Disable

This bit only controls the on/off of the LDO FET.

3.2. Battery FET Control:



FET Disable

Enable Turn Off

This bit only controls the on/off of the Battery FET .

3.3. Other Control.

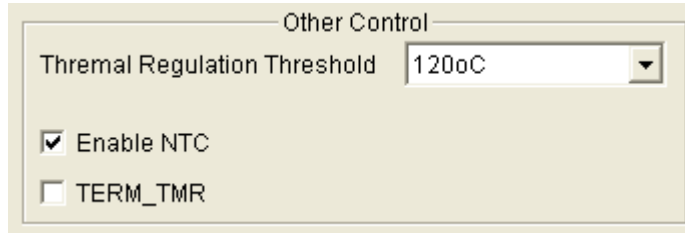

Other Control

Thermal Regulation Threshold 120oC

Enable NTC

TERM_TMR

TERM_TMR controls the operation after charge full, when the function is selected, the charge will go on charging even the charge current is hit the I_{BF} and status is read as charge full. It's effective only when EN_BF is selected.

3.4. Resistor Auto Monitor

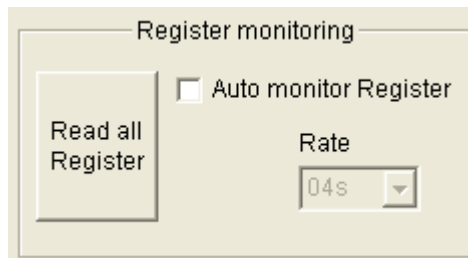

Register monitoring

Auto monitor Register

Read all Register

Rate 04s

3.5. Content of the Registers:

Register		7	6	5	4	3	2	1	0
Input Source Control (0X00)		0	0	1	1	0	1	1	1
Power_On Configuration (0X01)		R	R	0	R	0	1	0	0
Charge Current Control (0X02)		R	R	R	0	1	1	1	0
PRE/BF Current (0X03)		R	1	0	0	1	R	1	0
Charge Voltage Control (0X04)		1	0	1	0	0	0	1	1
Timer Control (0X05)		R	1	R	R	R	R	R	0
Miscellaneous Control (0X06)		R	R	0	0	1	0	1	1
System Status(0X07)		0	0	0	0	0	0	0	0
Fault (0X08)		0	R	0	0	0	R	0	0

3.6. Monitor the MP2660 operation status and Fault report

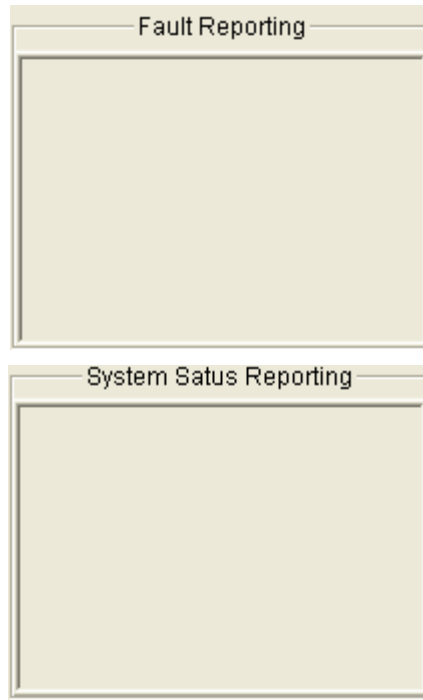

❖Notes❖

1. For the other detailed description on the operation of this part, please contact local FAE to apply the latest datasheet.

NOTICE: The information in this document is subject to change without notice. Users should warrant and guarantee that third party Intellectual Property rights are not infringed upon when integrating MPS products into any application. MPS will not assume any legal responsibility for any said applications.