



EV3318-C-00A

3-Channel, Step-Up White LED Driver with I²C Interface Evaluation Board

DESCRIPTION

The EV3318-C-00A is an evaluation board for the MP3318, a white LED step-up driver with a 2.7V to 5.5V input voltage range and 3-channel current sinks. The MP3318 uses peak current control mode to regulate the LED current set by an internal register.

The MP3318 integrates a 250mΩ, 42V MOSFET with a 38V maximum LED voltage output. The IC has the ability to drive LEDs in series for >5" liquid crystal display (LCD) panel applications.

The MP3318 features linear and exponential analog dimming with 11-bit, ultra-high resolution that regulates the dimming current. The IC's automatic switching frequency function optimizes efficiency.

In addition, the MP3318 offers LED open protection, LED short protection, cycle-by-cycle current limit protection, over-voltage protection (OVP), and thermal shutdown. The I²C interface can set the internal register to program the MP3318 for flexible applications, such as dimming mode, LED current ramp, and featured protection functions.

The MP3318 is available in an ultra-small WLCSP-12 (1.3mmx1.7mm) package.

ELECTRICAL SPECIFICATIONS

Parameter	Symbol	Value	Units
Input voltage	V _{IN}	2.7 to 5.5	V
Output voltage	V _{LED+}	<38	V
Number of LEDs		3 strings	
LED current/string	I _{LED}	25	mA

FEATURES

- 2.7 to 5.5V Input Voltage
- 42V, 250mΩ Internal MOSFET
- 3-Channel Current Sink with Enable (EN) Bits for Every Channel
- Up to 25mA LED Current in Backlight Mode
- Linear and Exponential Analog Dimming
- Up to 50mA LED Current in Flash Mode
- 11-Bit Dimming Resolution
- Excellent LED Current Accuracy
- Excellent LED String Current Matching
- 500kHz or 1MHz Switching Frequency with Optional -12% Shift
- 250kΩ, 500kΩ, or 1MΩ Automatic Switching Frequency
- 1.2MΩ High-Speed I²C Interface
- Internal Soft Start to Reduce Inrush Current
- 0.75A, 1A, 1.25A, or 1.5A Current Limit Protection
- 17V, 23V, 30V, or 38V LED Open Protection
- 2V, 3V, or 5V LED Short Protection
- Available in a WLCSP-12 (1.3mmx1.7mm) Package

APPLICATIONS

- Smartphones
- Tablets
- GPS Receivers
- Liquid Crystal Displays (LCDs) with Single-Cell Lithium-Ion Batteries

All MPS parts are lead-free, halogen-free, and adhere to the RoHS directive. For MPS green status, please visit the MPS website under Quality Assurance. "MPS", the MPS logo, and "Simple, Easy Solutions" are trademarks of Monolithic Power Systems, Inc. or its subsidiaries.

EV3318-C-00A EVALUATION BOARD



(LxW) 4.6cmx5cm

Board Number	MPS IC Number
EV3318-C-00A	MP3318GC

Efficiency vs. I_{LED}

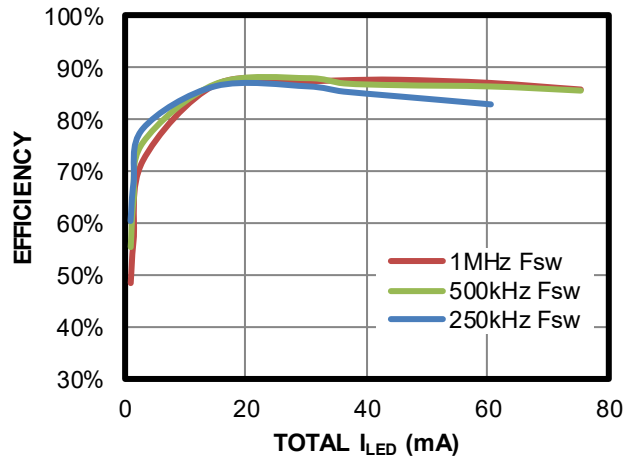

QUICK START GUIDE

1. Provide a voltage source between 2.7V and 5.5V from the VIN terminal to GND.
2. Connect the LED string terminals to:
 - a) Positive (+): LED+
 - b) Negative (-): LED1/2/3
3. To turn on the MP3318, drive the EN pin high.
4. Add a 50Hz to 50kHz PWM pulse to the PWM terminal. Choose a PWM frequency based on the sample frequency.
5. Connect the EVB's SCL, SDA, and GND pins to the SCL, SDA, and GND pins of a programmable kit with an I²C interface.
6. Write the registers and turn on the MP3318 by setting the EN bit (register 0x10, bit[0]) to 1.

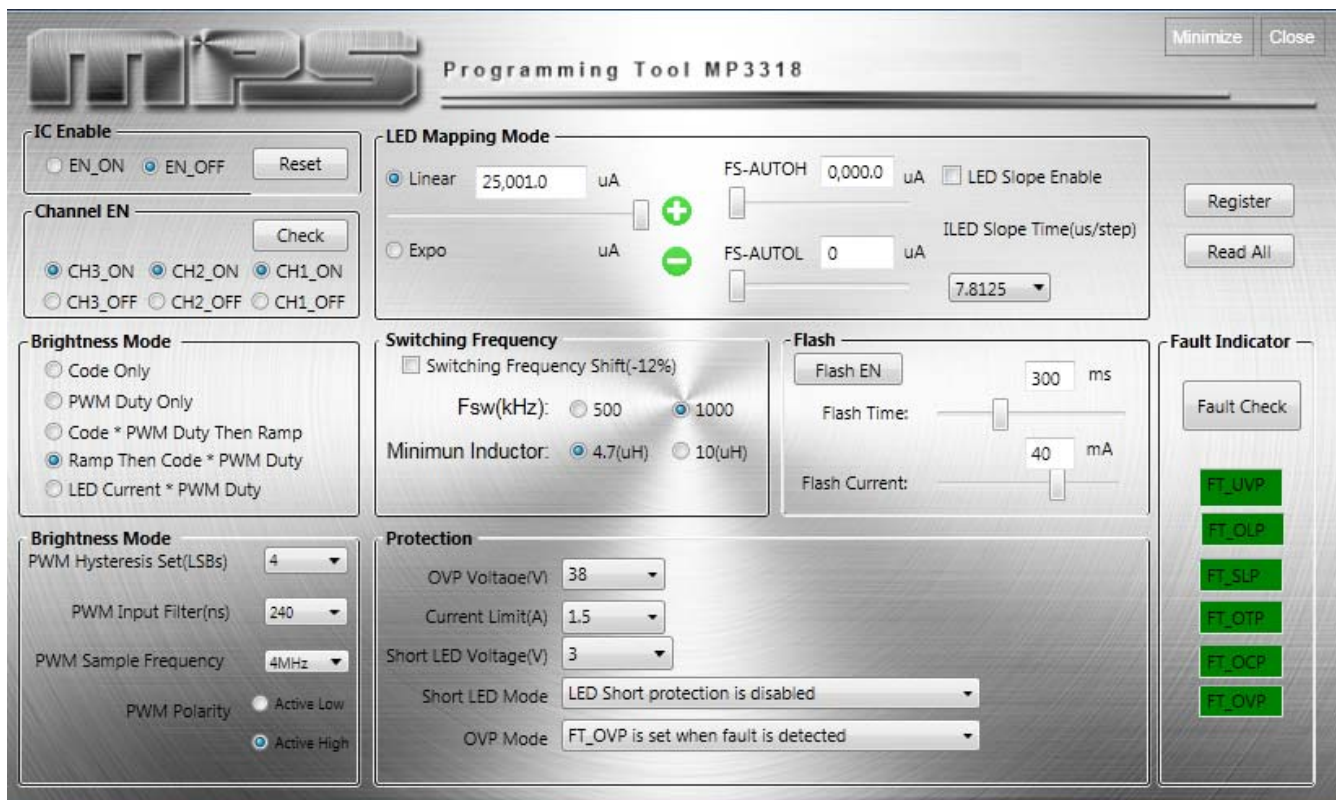

Figure 1: MP3318 MPS GUI Software

EVALUATION BOARD SCHEMATIC

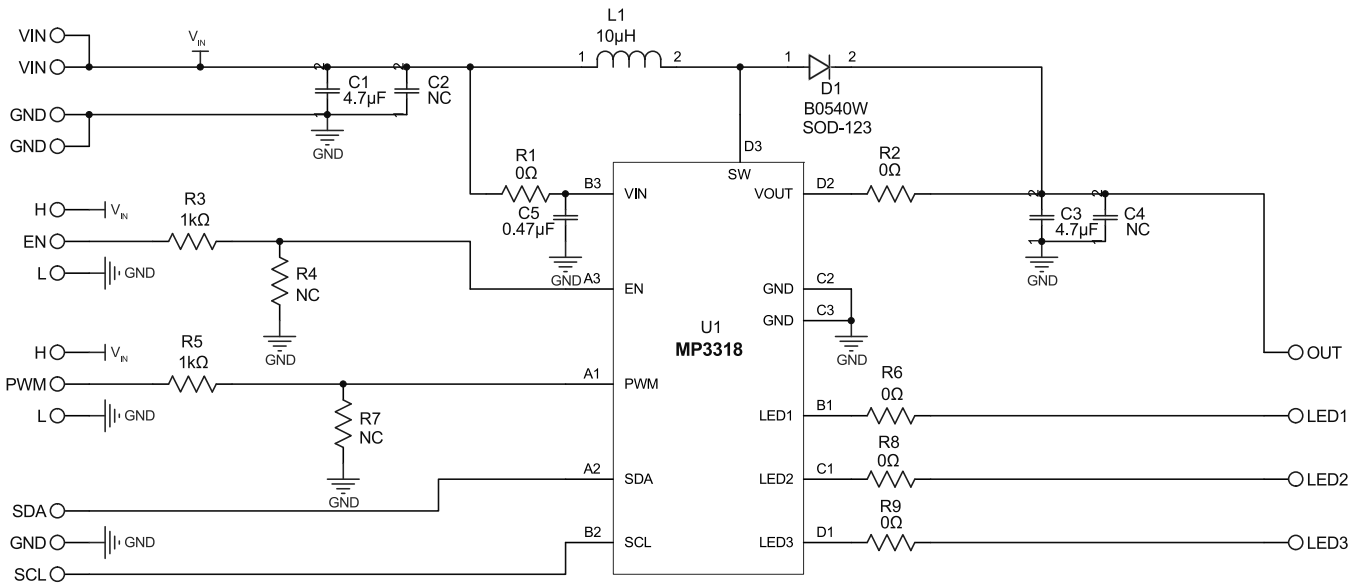

Figure 2: Typical Application Schematic with 3 strings (7 LEDs/string, 20mA/String)

EV3318-C-00A BILL OF MATERIALS

Qty	Ref	Value	Description	Package	Manufacturer	Manufacturer P/N
1	C1	4.7 μ F	Ceramic capacitor, 16V, X5R, 0805	0805	Murata	GRM21BR61C475KA88L
1	C3	2.2 μ F	Ceramic capacitor, 50V, X7R, 1206	1206	Murata	GJ8319R61H225K
1	C5	470nF	Ceramic capacitor, 16V, X7R, 0603	0603	Murata	GRM188R71C474KA88D
1	C2	NC	Ceramic capacitor, 0805	0805		
1	C4	NC	Ceramic capacitor, 1206	1206		
1	L1	10 μ H	Inductor, 10 μ H, 65.6m, 2.47A	SMD	Cooper	DR73-100-R
1	D1	B0540W	Diode, B0540, 0.5A, 40V	SOD-123	Diodes Inc.	B0540W
5	R1, R2, R6, R8, R9	0 Ω	Resistor, 5%	0603	Yageo	RTT03000JTP
2	R3, R5	1k Ω	Resistor, 5%	0603	Yageo	RC0603FR-071KL
2	R4, R7	NC	Resistor, 5%	0603		
1	U1	MP3318	White LED step-up driver	WLCSP-12 (1.3mmx 1.7mm)	MPS	MP3318GC

EVB TEST RESULTS

Performance waveforms are tested on the evaluation board. $V_{IN} = 3.6V$, 8 LEDs/string, 3 strings, $I_{LED}/ch = 20mA$, $L = 10\mu H$, $T_A = 25^\circ C$, unless otherwise noted.

LED Current Channels with Register Code

Current curve (code dimming only), 25mA/string

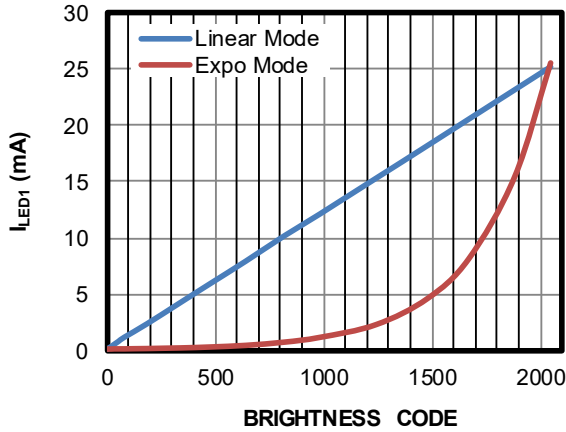

LED Current Channels with PWM Dimming

Current curve (PWM dimming only) 25mA/string

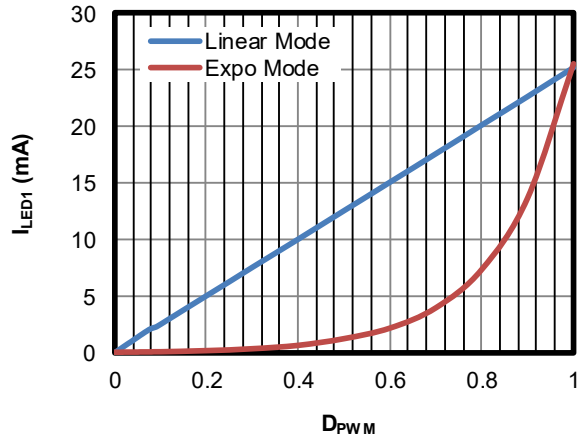

Efficiency vs. I_{LED}

$V_{IN} = 3.8V$, $f_{sw} = 1MHz$, $10\mu H$, $DCR = 280m\Omega$, 25mA/string

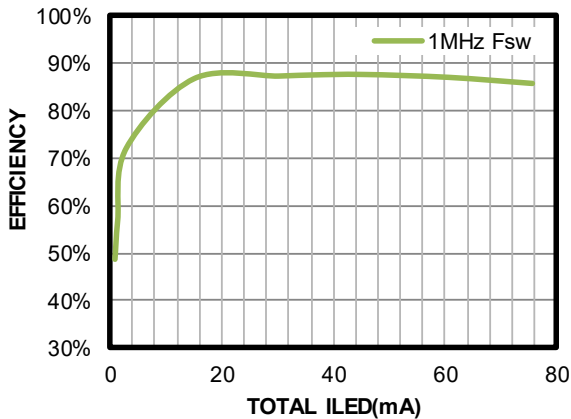

Efficiency vs. I_{LED}

$V_{IN} = 3.8V$, $f_{sw} = 500kHz$, $10\mu H$, $DCR = 280m\Omega$, 25mA/string

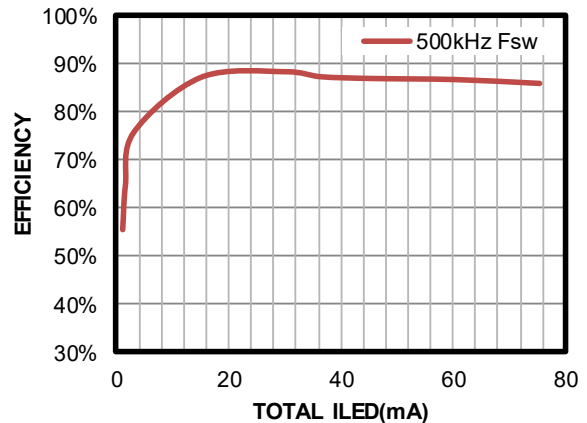

Efficiency vs. I_{LED}

$V_{IN} = 3.8V$, $f_{sw} = 250Khz$, $10\mu H$, $DCR = 280m\Omega$

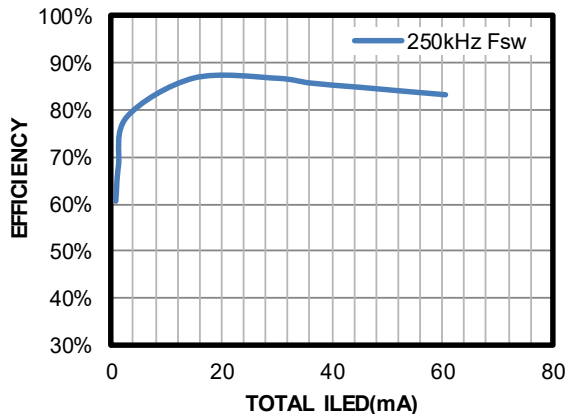

LED_x Voltage vs. LED Current

25mA/string

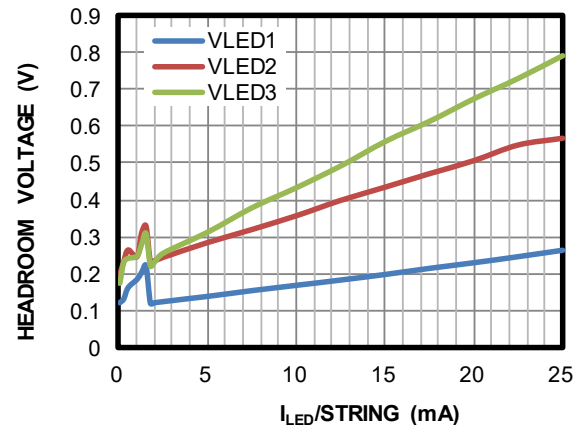

EVB TEST RESULTS (continued)

Performance waveforms are tested on the evaluation board. $V_{IN} = 3.6V$, 8 LEDs/string, 3 strings, $I_{LED}/ch = 20mA$, $L = 10\mu H$, $T_A = 25^{\circ}C$, unless otherwise noted.

Steady State

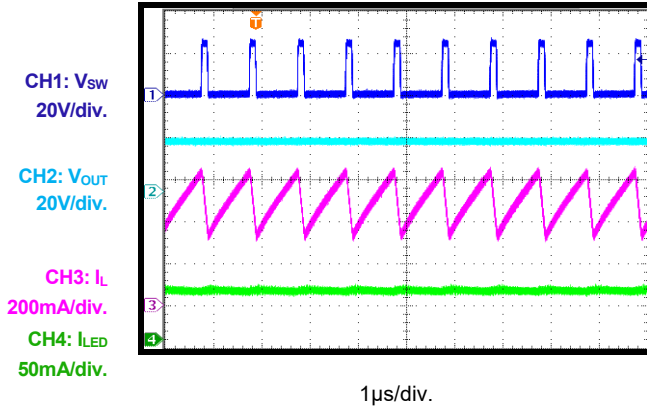

EN Bit On
62.5µs/step

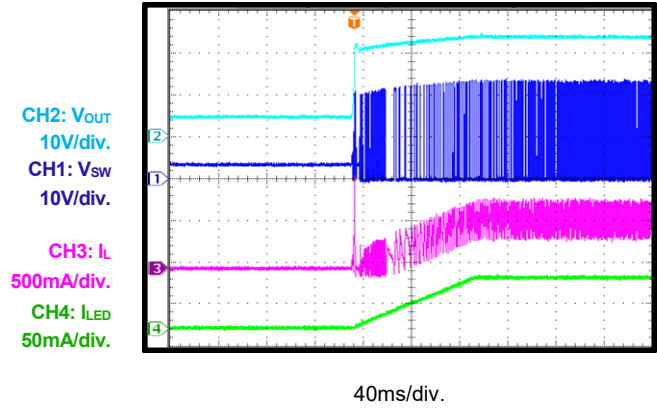

En Bit Off
62.5µs/step

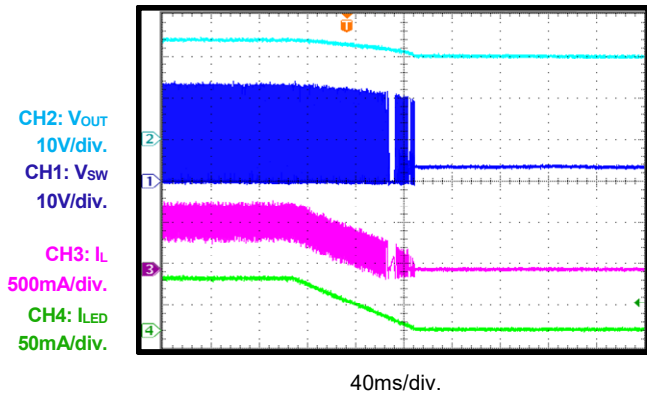

Flash Mode

Flash time = 300ms, flash current = 40mA/ch

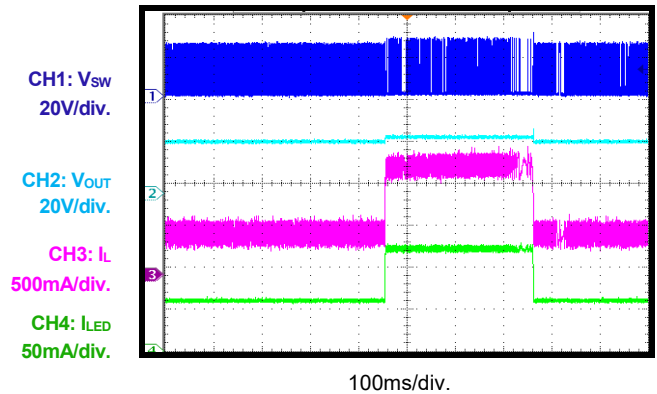

Open LED Protection (Marked Off)

$V_{ovp} = 30V$, 1 string open

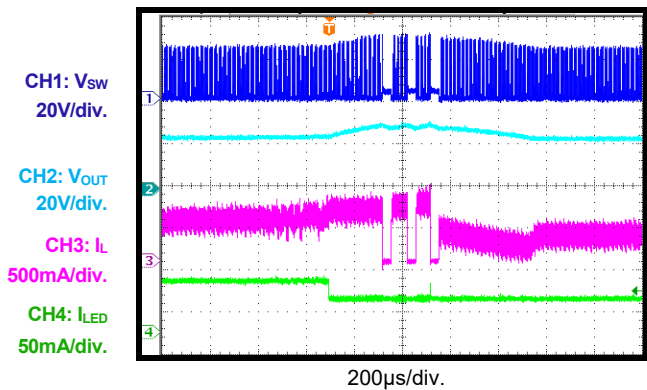

Short LED Protection (Marked Off)

1 string short

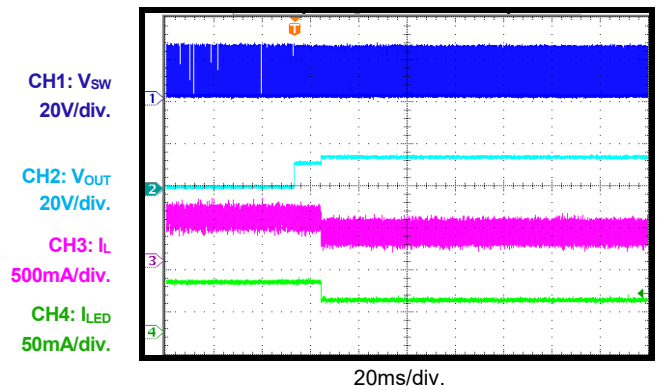

EVB TEST RESULTS *(continued)*

Performance waveforms are tested on the evaluation board. $V_{IN} = 3.6V$, 8 LEDs/string, 3 strings, $I_{LED}/ch = 20mA$, $L = 10\mu H$, $T_A = 25^\circ C$, unless otherwise noted.

Thermal Shutdown (Recoverable)

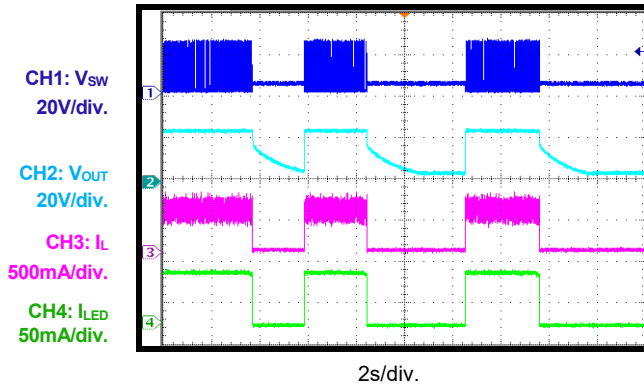

PCB LAYOUT

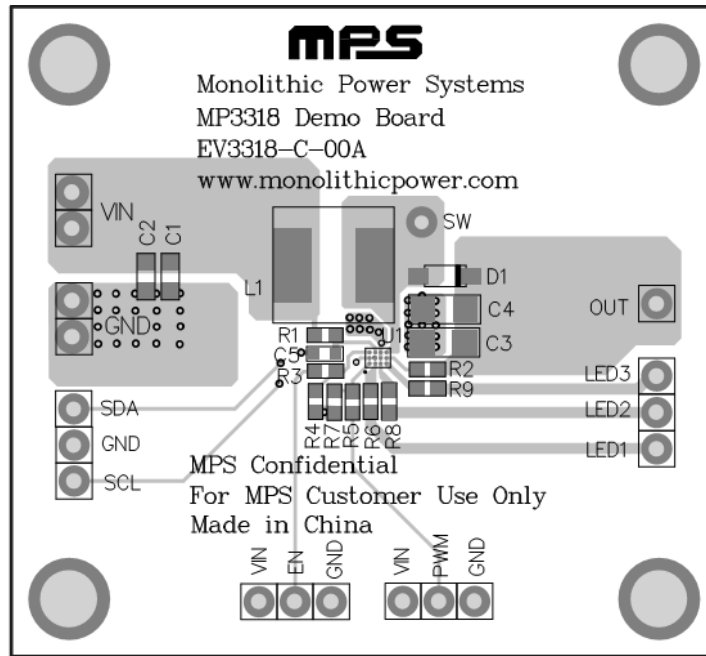

Figure 3: Top Layer

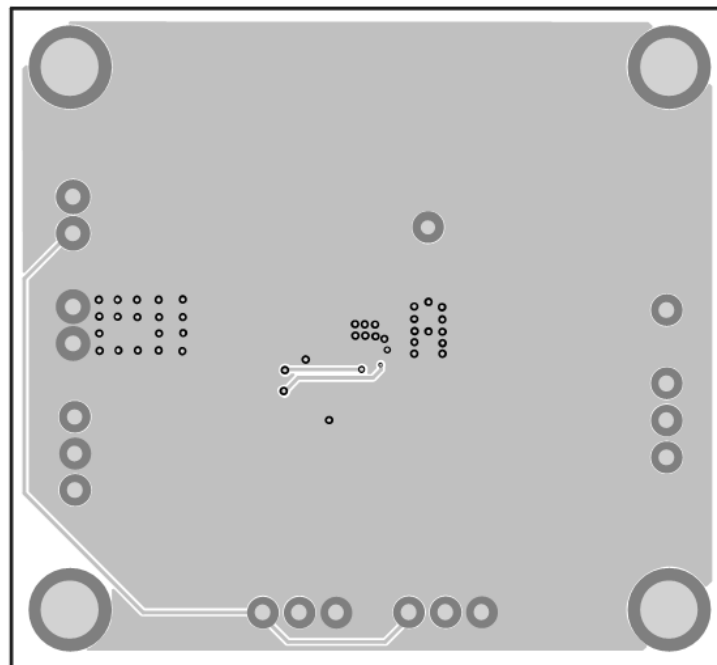

Figure 4: Bottom Layer

REVISION HISTORY

Revision #	Revision Date	Description	Pages Updated
1.0	1/18/2021	Initial Release	-

Notice: The information in this document is subject to change without notice. Please contact MPS for current specifications. Users should warrant and guarantee that third-party Intellectual Property rights are not infringed upon when integrating MPS products into any application. MPS will not assume any legal responsibility for any said applications.