

## DESCRIPTION

The MP3332 is a dual-channels flash LED driver with very compact package, high efficiency for high-resolution camera phones to improve image and video quality in low light environment. The synchronous boost converter operates in 1/2/3/4MHz to provide an optimized solution for smaller PCB space and higher efficiency.

The MP3332 features standard I<sup>2</sup>C interface, dual LED channels, rich protection modes and high power density and performances. The MP3332 supports flash/assist light/torch/indicator/5V DC modes.

The cathodes of the dual flash LED are referenced to GND for better layout to improve thermal performance. It is available in WLCSP16-1.65X1.65mm package.

## ELECTRICAL SPECIFICATIONS

Parameter	Symbol	Value	Units
Input Voltage	V <sub>IN</sub>	2.7-5.5	V
Output Voltage	V <sub>out</sub>	<5.5	V
LED channel		2	
LED Current/Ch	I <sub>LED</sub>	1500	mA

## FEATURES

- 2.7V~5.5V input voltage
- Dual-channels, 1.5A/ch flash current with +/-7% accuracy
- 1/2/3/4MHz selectable switching frequency and switching frequency fold-back function
- 400kHz I<sup>2</sup>C compatible interface
- Standby/Flash/Assist/Torch/Indicator/5V DC modes

### Flash Mode:

Up to 1.5A programmable current with +/-7% accuracy for each LED

### Assist/Torch Mode:

Up to 500mA/ch programmable current with +/-7% accuracy

### Indicator Mode:

Work in 31.5kHz PWM operation with 2/16, 3/16, 4/16, 5/16 duty cycle  
128ms/256ms/512ms selectable blinking time

### 5V DC Mode:

Constant 5V DC Output

- External Torch/Strobe Pin
- LED forward voltage balance to improve efficiency
- 1A to 4.2A programmable input DC current limit protection
- Low battery voltage protection
- LED short/open protection
- Over voltage protection
- Over temperature protection
- Input under voltage lockout protection
- Available in WLCSP16-1.65X1.65mm

## APPLICATIONS

- LED Flash Application For Smart Phone
- Camera For Tablets
- Digital Still Camera

All MPS parts are lead-free, halogen free, and adhere to the RoHS directive. For MPS green status, please visit MPS website under Quality Assurance. "MPS" and "The Future of Analog IC Technology" are Registered Trademarks of Monolithic Power Systems, Inc.

## EV3332-C-00A EVALUATION BOARD

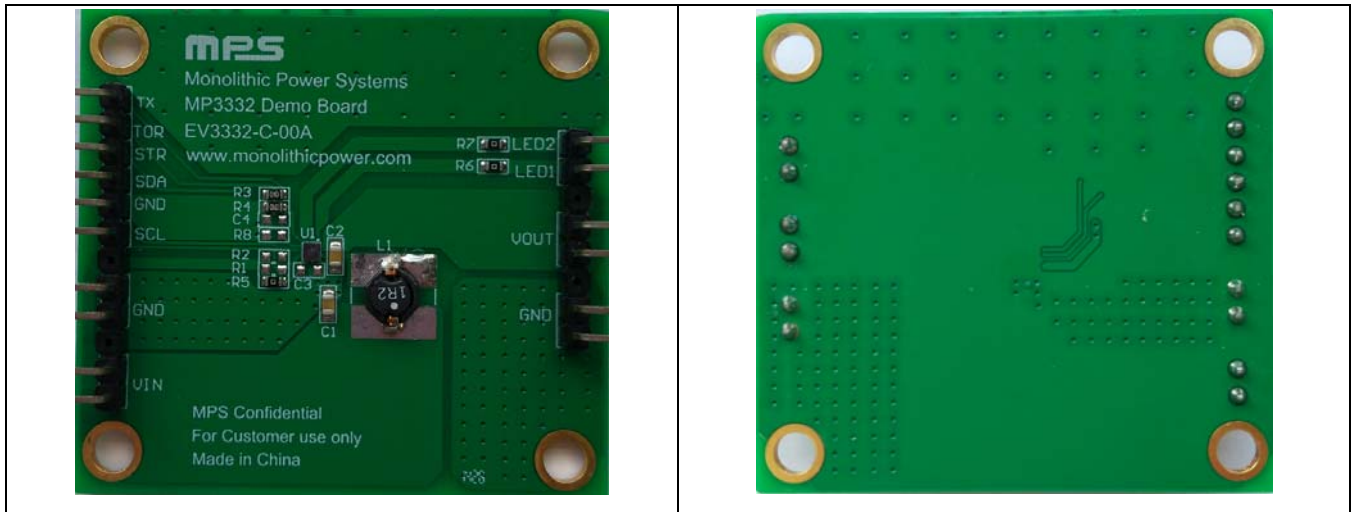

(L x W x H) 5.0cm x 4.6cm x 3.0cm

Board Number	MPS IC Number
EV3332-C-00A	MP3332GC

## EVALUATION BOARD SCHEMATIC

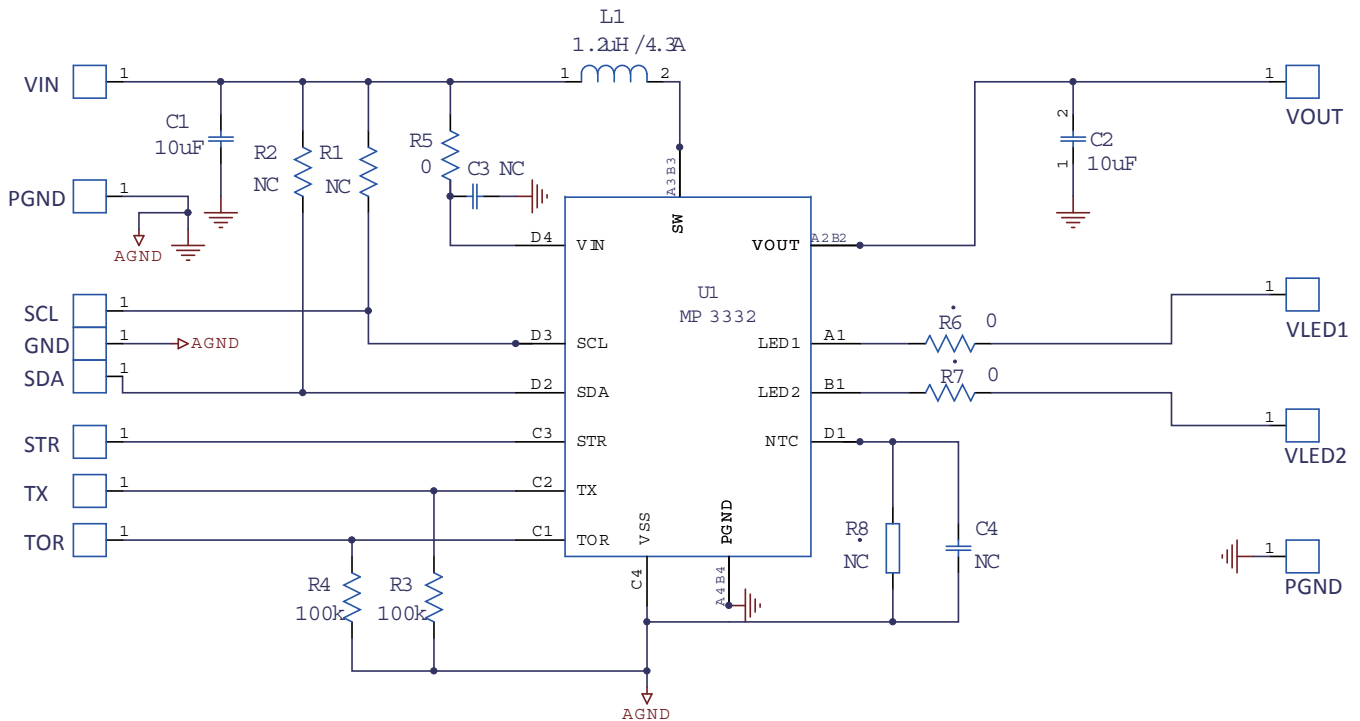

## EV3332-C-00A BILL OF MATERIALS

Qty	Ref	Value	Description	Package	Manufacturer	Part Number
2	R3,R4	100k	res,5%	0603	Yageo	RC0603JR-07100KL
3	R6,R7,R5	0	res,1%	0603	Yageo	RC0603FR-070RL
3	R1,R2, R8	NC		0603		
2	C1,C2	10uF	Ceramic Capacitor,10V,X5R	0805	muRata	GRM21BR61A106KE19L
2	C3, C4	NC				
1	L1	1.2uH	Inductor, DCR=25m, IDC=4.3A	SMD	TDK	LTF-5022T-1R2N4R2
1	U1			CSP16/1.65*1.65	MPS	MP3332

## EVB TEST RESULTS

Performance waveforms are tested on the evaluation board.

V<sub>IN</sub> = 3.6V, 1\*LEDs, FL\_TIM=100ms, L = 1.2μH, T<sub>A</sub> = 25°C, unless otherwise noted.

**Torch/Assist Mode**  
LED\_EN enable

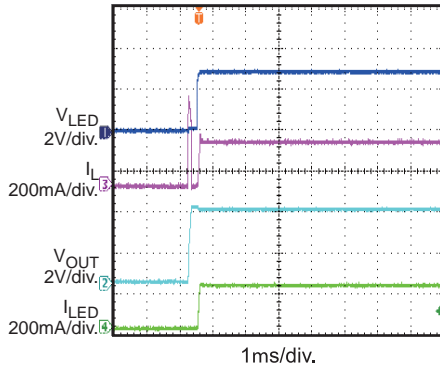

**Torch/Assist Mode**  
LED\_EN disable

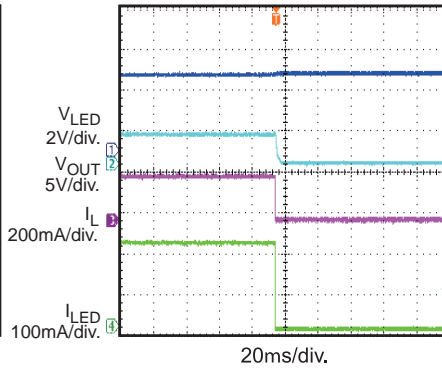

**Indicator Mode**  
ILED Duty=2/16

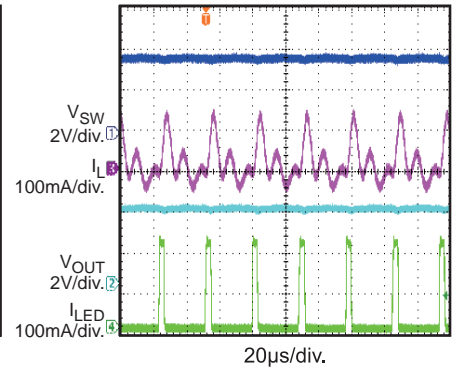

**Blinking Mode and Indicator Mode**  
Blinking Time=128ms

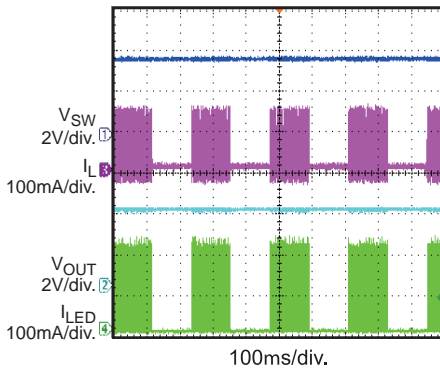

**Flash Mode**  
flash time=100ms

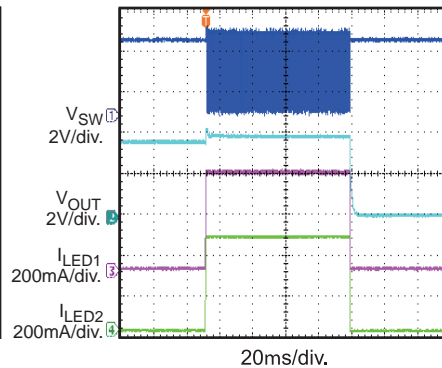

**5V\_DC Mode**  
With light load

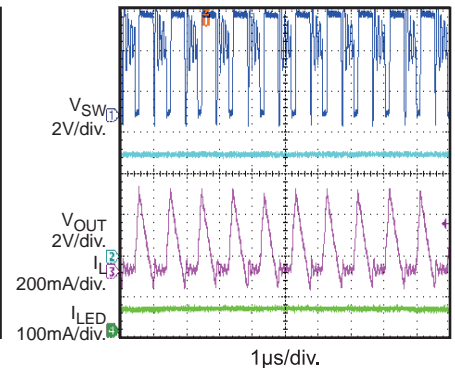

**Torch/Assist Mode to Flash Mode**

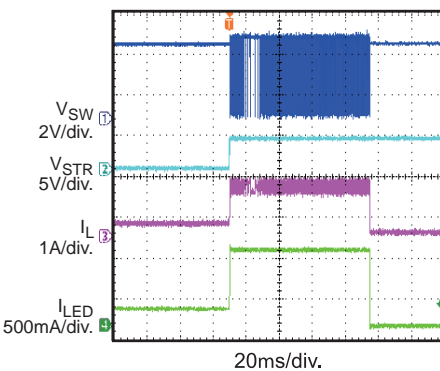

**TX pin is high**  
In flash Mode

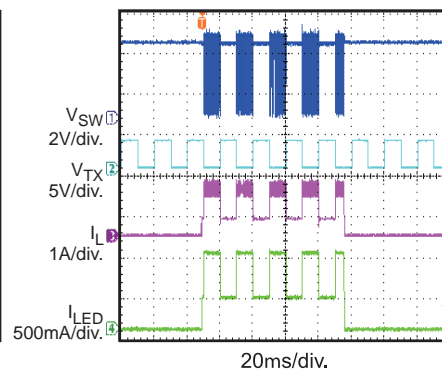

**Load Balancing**  
from disable this function to enable

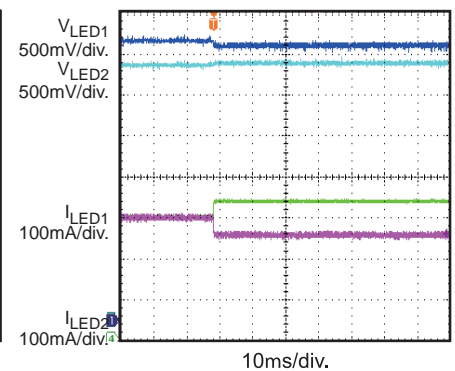

## EVB TEST RESULTS (continued)

V<sub>IN</sub> = 3.6V, 1\*LEDs, FL\_TIM=100ms, L = 1.2μH, T<sub>A</sub> = 25°C, unless otherwise noted.

**Short one channel  
when working**

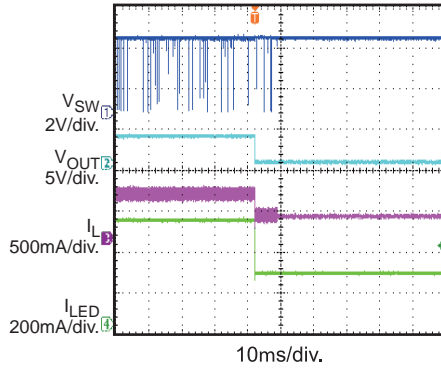

**Open one string  
Protection  
when working**

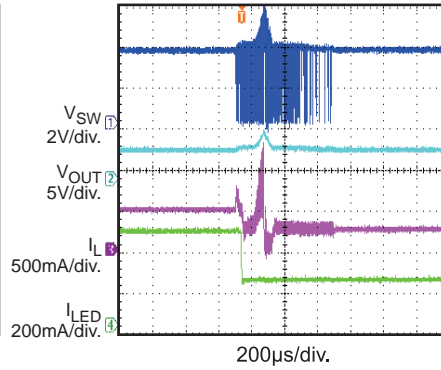

**Vout to GND short  
Protection**

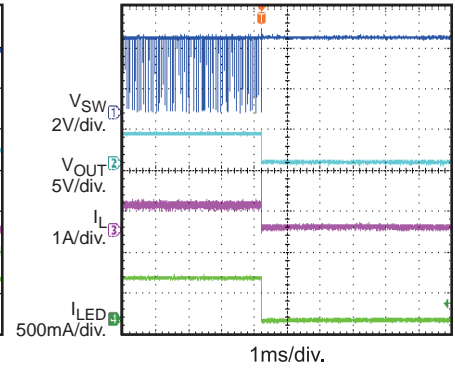

**Thermal Protection**

In flash mode,  
LED\_OTAD=1

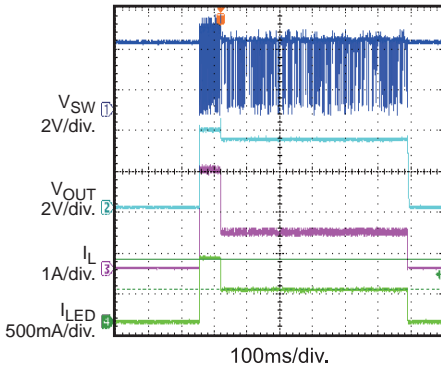

**NTC Detection**

Set NTC\_WD=0.88V

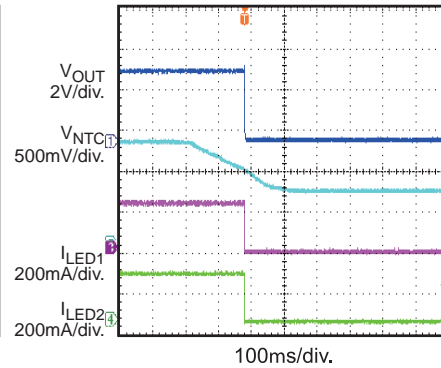

## PRINTED CIRCUIT BOARD LAYOUT

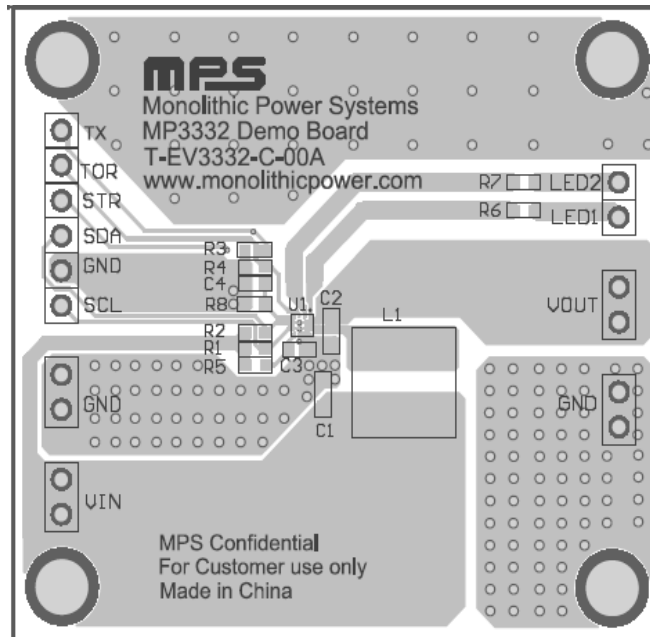

Figure 1—Top Layer

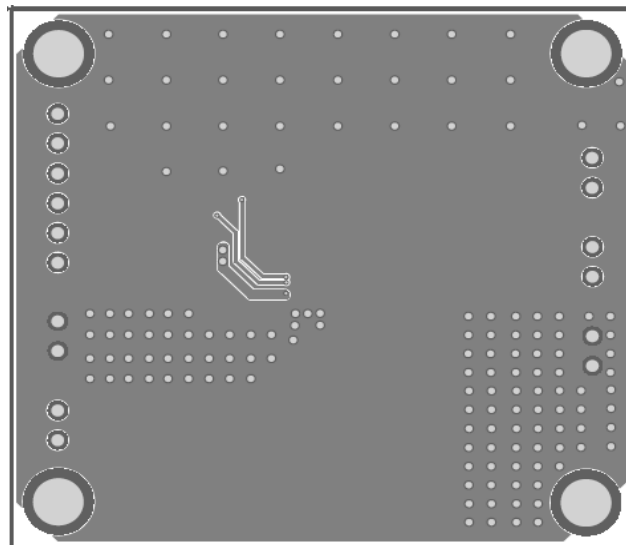
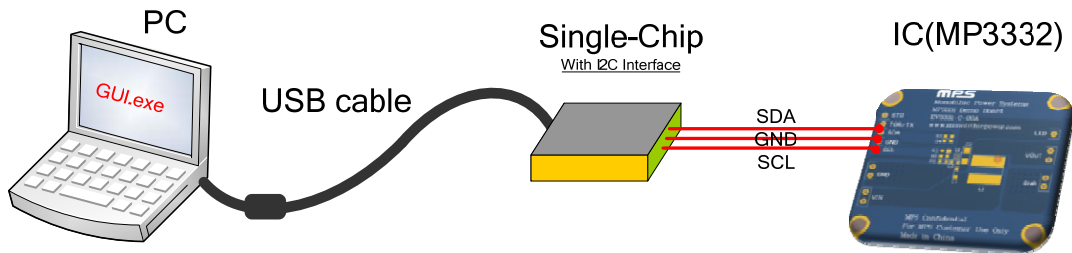

Figure 2—Bottom Layer

## QUICK START GUIDE

1. Connect the positive and negative terminals of the power supply (2.7V ~ 5.5V) to the VIN and GND pins on the EV board, respectively.
2. Connect the positive and negative terminals of the LED to the LED terminal and GND on the EV board, respectively.
3. Please connect SCL, SDA and GND of EV board to SCL, SDA and GND of a programmable kit with I<sup>2</sup>C interface, respectively. I<sup>2</sup>C is active only when Vin powers on.



4. When work in Torch mode, please pull torch terminal to high. When work in flash mode with hardware level or edge sensitive, please give a level or pulse signal to STR pin. It is OK that STR is float or connected to a high/level if trigger flash with software.

**NOTICE:** The information in this document is subject to change without notice. Users should warrant and guarantee that third party Intellectual Property rights are not infringed upon when integrating MPS products into any application. MPS will not assume any legal responsibility for any said applications.