



The Future of Analog IC Technology®

EV3366-C-00A

6 Strings Boost White LED Driver Evaluation Board

DESCRIPTION

The MP3366 is a step-up converter with 6-channel current sources. It is designed for driving the white LED arrays as backlighting of mid- or larger- sized LCD panel.

The MP3366 uses peak-current mode as its PWM control architecture. The switching frequency can be programmed by a resistor. It generates an output voltage up to 45V from a 3V to 25V input supply. The MP3366 independently regulates the current in each LED string to the value set by an external current-setting resistor.

The MP3366 applies 6 internal current sources in each LED string terminal to achieve a current balance with 1.5% current regulation accuracy between strings. Its low 500mV regulation voltage on LED current sources reduces power loss.

The MP3366 features external digital PWM dimming and analog dimming, both of which sharing a single input with 25% PWM duty cycle as a transfer point. The mix-dimming strategy helps to improve the dimming ratio. Also, MP3366 automatically transfers the PWM input signal 100Hz to 20kHz frequency to 23.5kHz to 29.5kHz to eliminate the audible noise.

MP3366 has rich protection modes to guarantee safety operation. The protection modes include recoverable OCP (over-current protection), OVP (over-voltage protection), OTP (over-temperature protection), any string of LED short and open protection.

The MP3366 is available in CSP-18(1.35mmX2.55mm) package.

ELECTRICAL SPECIFICATIONS

Parameter	Symbol	Value	Units
Input Voltage	V_{IN}	3 – 25	V
Output Voltage	V_{LED}	<50	V
LEDs #		6 string	
LED Current	I_{LED}	20/string	mA

FEATURES

- 6-String, Max 45mA/String
- 3V to 25V Input Voltage Range
- 1.5% Current Matching Accuracy Between Strings
- 600kHz Switching Frequency
- Combined Analog and PWM Dimming Mode with 25% Dimming Transfer Point
- 23.5kHz to 29.5kHz Output Dimming Frequency to eliminate audible noise
- Programmable Over-Voltage Protection
- Recoverable Thermal Shutdown Protection
- Cycle by Cycle Over Current Protection
- Under-Voltage Lockout
- Available in a WLCSP-18(1.35X2.55mm) Package

APPLICATIONS

- Tablets
- NBs
- Handy Terminals Display

All MPS parts are lead-free, halogen free, and adhere to the RoHS directive. For MPS green status, please visit MPS website under Quality Assurance. "MPS" and "The Future of Analog IC Technology" are Registered Trademarks of Monolithic Power Systems, Inc.

EV3366-C-00A EVALUATION BOARD

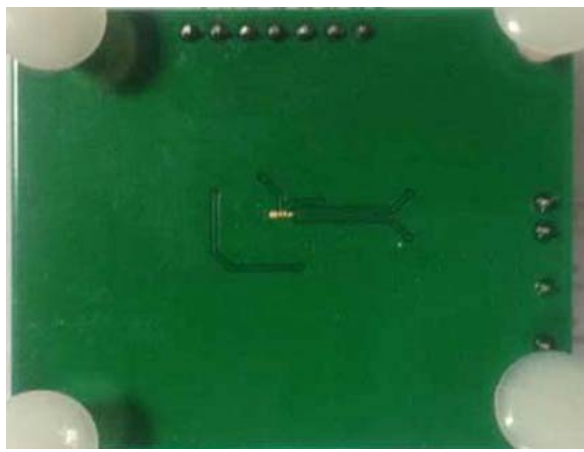
	
(L x W x H) 5cm x 4cm x 1.0cm	
Board Number	MPS IC Number
EV3366-C-00A	MP3366GC

EVALUATION BOARD SCHEMATIC

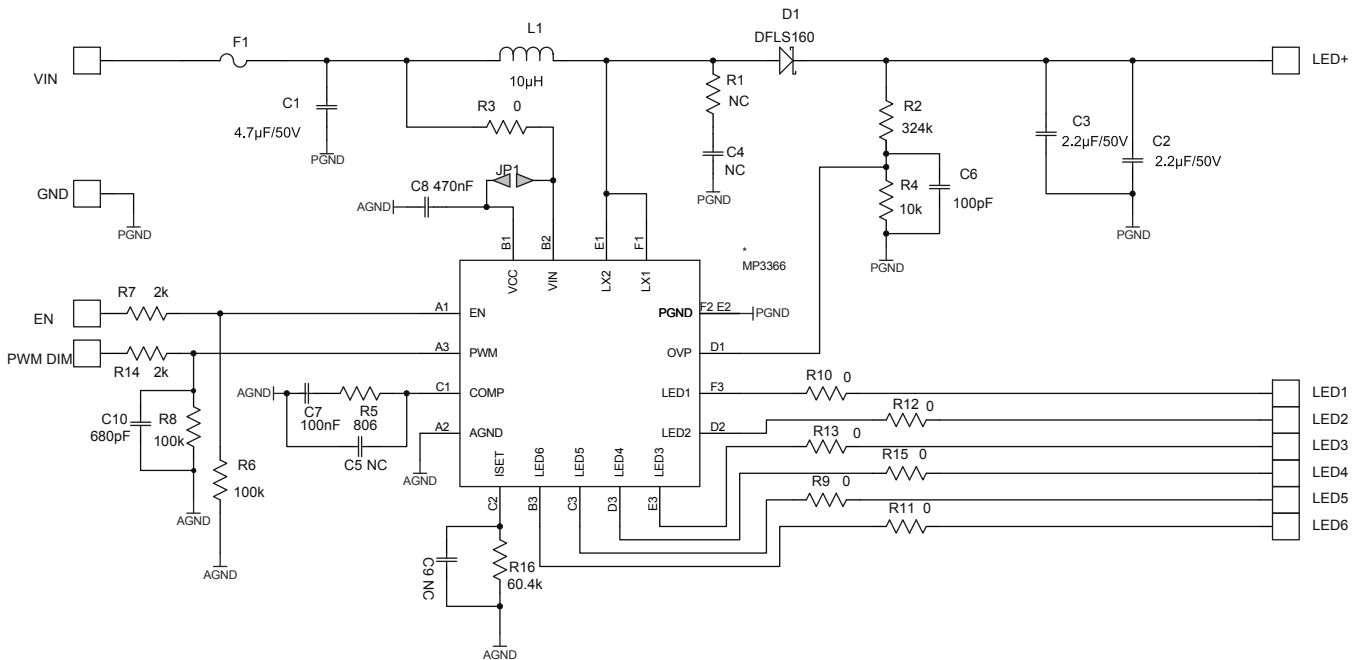

EV3366-C-00A BILL OF MATERIALS

Qty	Ref	Value	Description	Package	Manufacturer	Part Number
1	C1	4.7 μ F	Ceramic Capacitor, 50V, X7R	1210	Murata	GRM32ER71H475KA8
2	C2,C3	2.2 μ F	Ceramic Capacitor, 50V, X7R	1206	Murata	GJ8319R61H225K
3	C4,C5,C9	NC				
1	C6	100pF	Ceramic Capacitor, 50V	0603	Murata	GRM1885C1H101JA01D
1	C7	100nF	Ceramic Capacitor, 16V, X7R	0603	Murata	GCJ188R71H104KA12D
1	C8	0.47 μ F	Ceramic Capacitor, 16V, X5R	0603	Murata	GRM188R71C47KA88D
1	C10	680pF	Ceramic Capacitor, 50V, X7R	0603	Murata	GRM188R71H681KA01D
1	D1	B160	Diode Schottky, 60V, 1A	SMA	Diodes Inc	B160
1	L1	10 μ H	Inductor,DCR=80 Ω	SMD	WURTH	7440700100
1	F1	0 Ω	Resistor, 1%	1206	Yageo	RC1206JR-070RL
1	R1	NC				
1	R2	324k Ω	Resistor, 1%	0603	Yageo	RC0603FR-07324KL
8	JP1,R3,R9,R10, R11,R12, R13,R15	0 Ω	Resistor, 1%	0603	Yageo	RC0603JR-070RL
1	R4	10k Ω	Resistor, 1%	0603	Yageo	RC0603FR-0710KL
1	R5	806 Ω	Resistor, 1%	0603	Yageo	RC0603FR-07806RL
2	R6,R8	100k Ω	Resistor, 1%	0603	Yageo	RC0603JR-07100KL
2	R7,R14	2k Ω	Resistor, 5%	0603	Yageo	RC0603JR-0702KL
1	R16	60.4k Ω	Resistor, 1%	0603	Yageo	RC0603FR-0760K4L
1	U1		LED Driver IC	CSP18	MPS	MP3366, R6
11	VIN,GND, EN,PW MDIM,LE D+,LED1 ,LED2,LE D3,LED4 ,LED5,LE D6	bend terminal	Connector			单排, 2.54mm, 90度

EVB TEST RESULTS

Performance waveforms are tested on the evaluation board.

$V_{IN} = 7V$, 8 LEDs in series, 6 strings in parallel, 20mA/string, $T_A = 25^{\circ}C$, unless otherwise noted.

Steady State

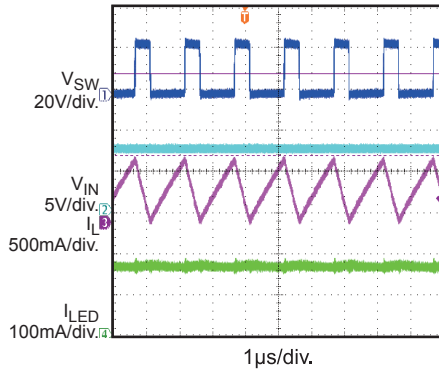

V_{IN} Power On

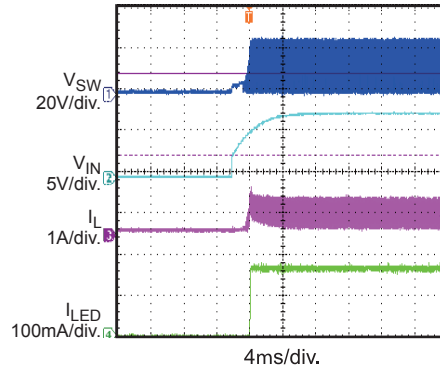

V_{IN} Power Off

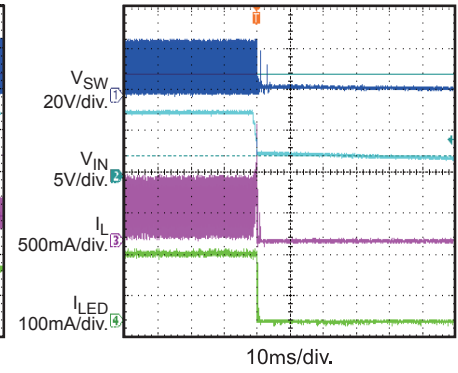

EN Power On

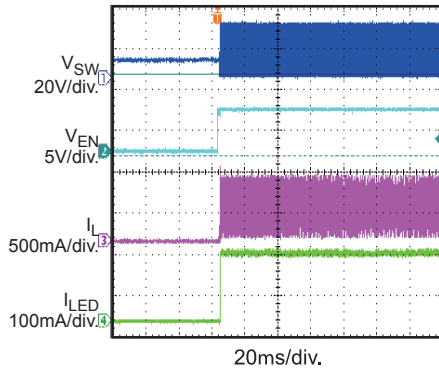

EN Power Off

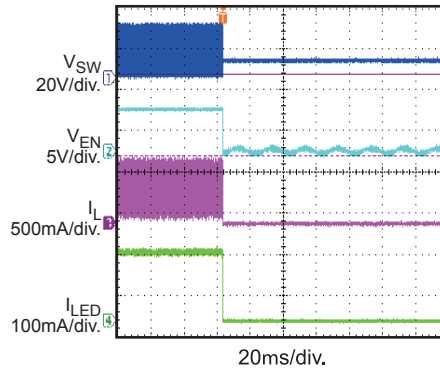

Mix Dimming

$F_{SW} = 200Hz$, $D = 25\%$

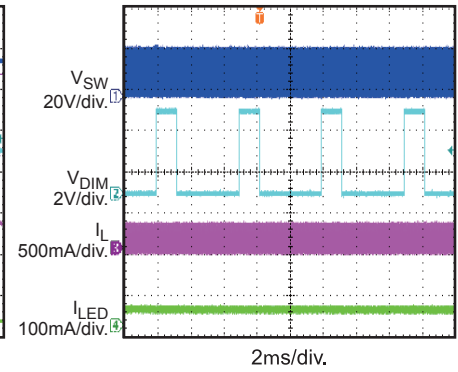

Mix Dimming

$F_{SW} = 200Hz$, $D = 24\%$

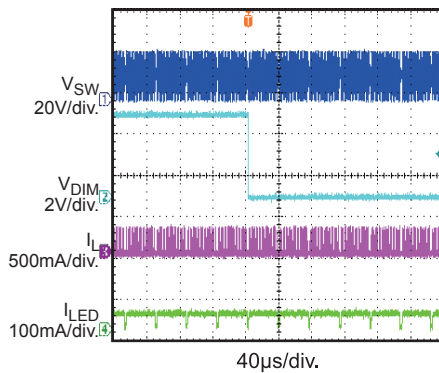

Mix Dimming Linearity

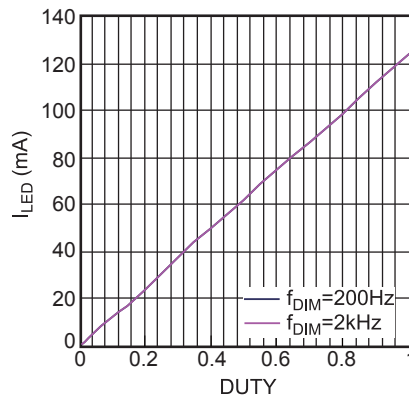

EVB TEST RESULTS *(continued)*

Performance waveforms are tested on the evaluation board.

$V_{IN} = 7V$, 8 LEDs in series, 6 strings in parallel, 20mA/string, $T_A = 25^{\circ}C$, unless otherwise noted.

Start-Up when Open Load

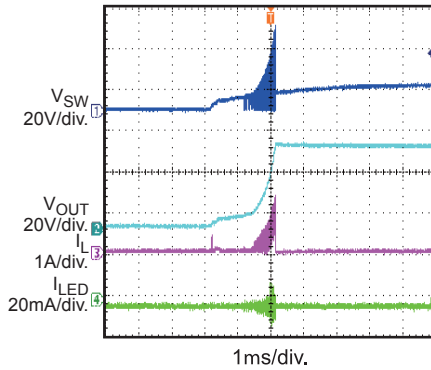

Open Load when Work Normally

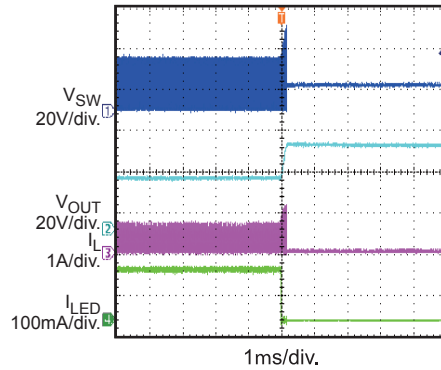

Open 1 String when Work Normally

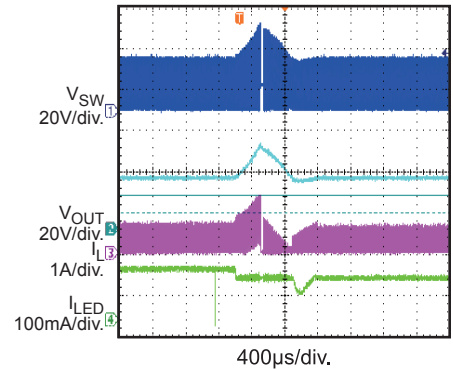

Start-Up when Open 1 String

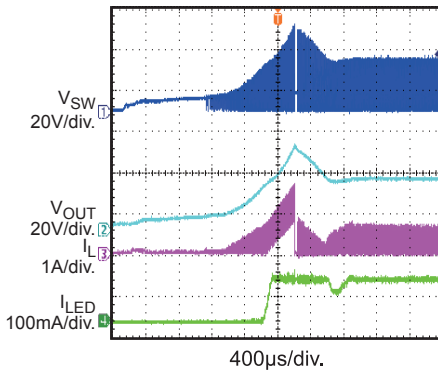

Start-Up when Short 1 String

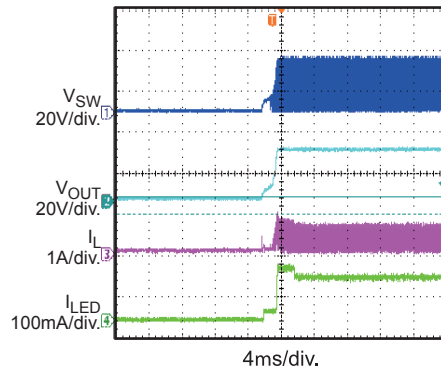

Short 1 String when Work Normally

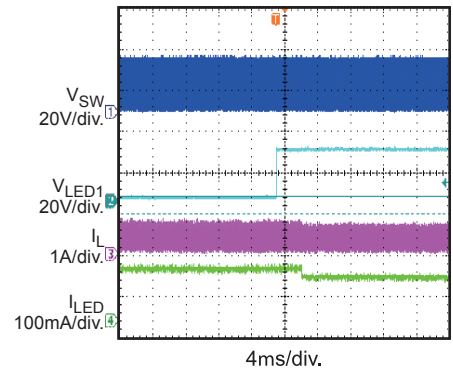

Thermal Protection

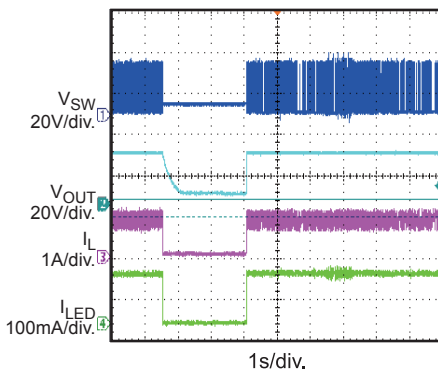

PRINTED CIRCUIT BOARD LAYOUT

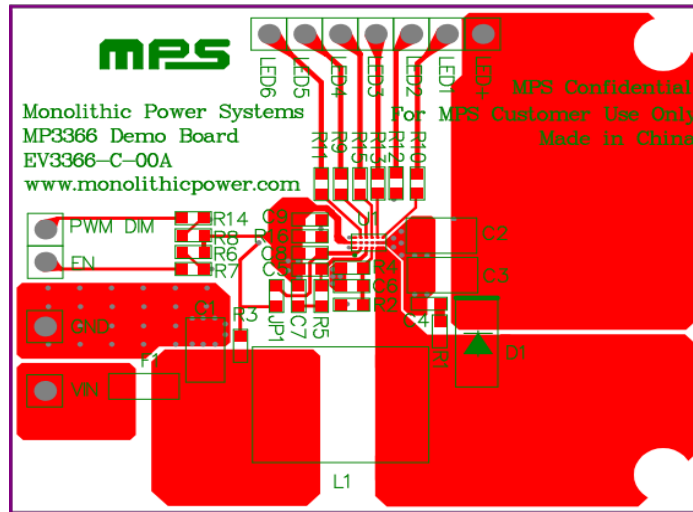

Figure 1—Top Layer

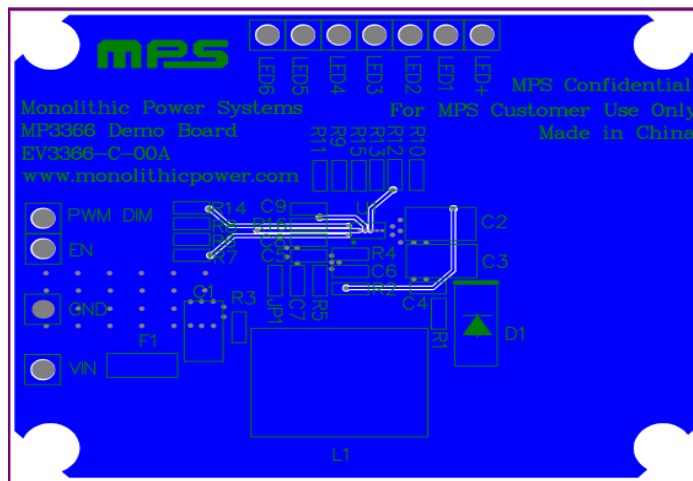

Figure 2—Bottom Layer

Note:
A 680pF Ceramic Capacitor named C10 is in parallel with R8 to eliminate the noise from PWM input.

QUICK START GUIDE

1. Connect the positive and negative terminals of the load panel (6 strings) to the LED+ and LED1~6 pins on the EV board, respectively.
2. Connect the positive and negative terminals of the power supply (3V ~ 25V) to the VIN and GND pins on the EV board, respectively.
3. Drive EN pin high (5V) to enable the MP3366
4. Drive PWM pin with 200Hz~20kHz pulse signal, the dim duty is low to 1% in Mix dim mode. A 680pF Ceramic Capacitor that connected between PWM pin and GND can eliminate the noise from PWM input.
5. Set current of every string by R16 at ISET pin.
6. Connect VCC and VIN together through JP1 if VIN is below 5V.

NOTICE: The information in this document is subject to change without notice. Please contact MPS for current specifications. Users should warrant and guarantee that third party Intellectual Property rights are not infringed upon when integrating MPS products into any application. MPS will not assume any legal responsibility for any said applications.