



# EV3367-R-00A

## 6-Channel, Maximum 150mA/Ch Boost WLED Driver with 15000:1 Dimming Ratio and I<sup>2</sup>C

### DESCRIPTION

The MP3367 is a step-up converter with six channel current sources. It is designed to drive the white LED arrays as backlighting for small- or medium-sized LCD panels.

The device uses peak current mode as its PWM control architecture to regulate the boost converter. Six channel current sources are applied to the LED cathode to adjust the LED brightness. The MP3367 regulates the current in each LED string to the value set by an external current-setting resistor, with 2.5% current regulation accuracy between strings.

A low on resistance MOSFET and a low headroom voltage are provided to improve efficiency. The MP3367 has a standard I<sup>2</sup>C digital interface for easy use. The switching frequency can be configured via a resistor, I<sup>2</sup>C interface, or external clock.

The MP3367 provides analog, PWM, and mix dimming modes with a PWM input. The dimming mode can be selected with the I<sup>2</sup>C interface or the MIX/AD pin. The device also has a phase shift function to eliminate noise during PWM dimming.

Robust protections guarantee safe operation of the device, and include over-current protection (OCP), over-voltage protection (OVP), over-temperature protection (OTP), and LED short and open protection. The MP3367's LED current automatically decreases at higher temperatures.

The MP3367 is available in a QFN-24 (4mmx4mm) package.

### ELECTRICAL SPECIFICATIONS

Parameter	Symbol	Value	Units
Input voltage	V <sub>IN</sub>	12	V
Output voltage	V <sub>LED</sub>	<50	V
LEDs #		6 strings	
LED current/ string	I <sub>LED</sub>	50	mA

### FEATURES

- 3.5V to 36V Input Voltage Range
- 6 Channels with Max 150mA per Channel
- Internal 100mΩ, 50V MOSFET
- Up to 2.2MHz Configurable Switching Frequency
- External Sync SW Function
- Multi-Dimming Operation Mode via PWM Input, including:
  - Direct PWM Dimming
  - Analog Dimming
  - Mix Dimming with 25% or 12.5% Transfer Point
- 15000:1 Dimming Ratio in PWM Dimming at f<sub>PWM</sub> ≤ 200Hz
- 200:1 Dimming Ratio at Analog Dimming via PWM Dimming Signal Input
- Excellent EMI Performance, Frequency Spread Spectrum
- I<sup>2</sup>C Interface
- Phase Shift for PWM Dimming
- 2.5% Current Matching
- Cycle-by-Cycle Current Limit
- Disconnect VOUT from VIN
- LED Current Auto-Decrement at High Temperatures
- LED Short/Open, OTP, OCP, Inductor Short Protection
- Configurable LED Short Threshold
- Configurable OVP Threshold
- Fault Indicator Signal Output
- Available in a QFN-24 (4mmx4mm) Package

### APPLICATIONS

- Tablets/Notebooks
- Automotive Displays

All MPS parts are lead-free, halogen-free, and adhere to the RoHS directive. For MPS green status, please visit the MPS website under Quality Assurance. "MPS", the MPS logo, and "Simple, Easy Solutions" are trademarks of Monolithic Power Systems, Inc. or its subsidiaries.

### EV3367-R-00A EVALUATION BOARD

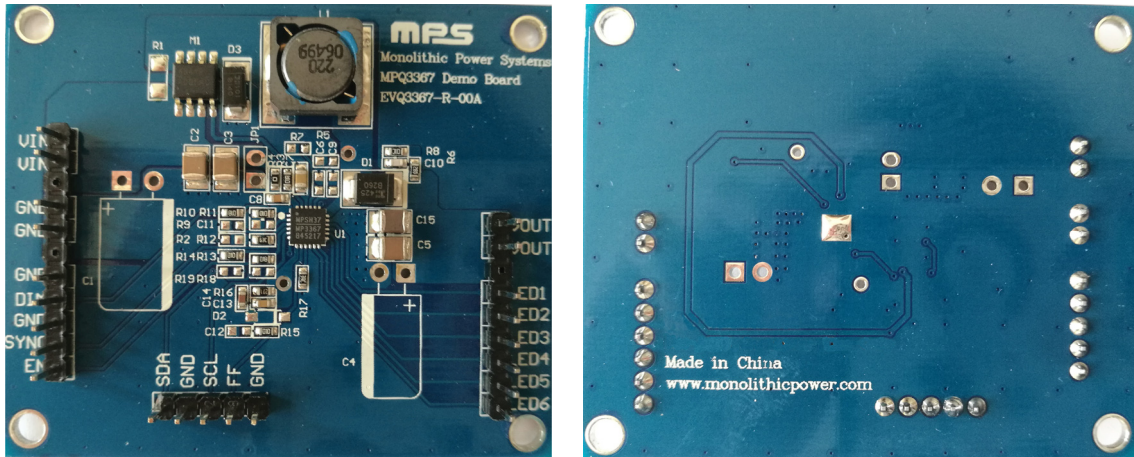

(LxW): 6.35cmx5.25cm

Board Number	MPS IC Number
EV3367-R-00A	MP3367GR

## QUICK START GUIDE

1. Provide a 3.5V to 36V voltage source between the VIN terminal and GND on the evaluation board.
2. Connect the LED load (6 strings) to:
  - a) Positive (+): LED+
  - b) Negative (-): LED1–LED6
3. Drive the EN pin high to enable the MP3367.
4. Add a PWM pulse (between 100Hz to 20kHz) to the PWM terminal.
5. Connect the SCL, SDA, and GND pins of the evaluation board to their respective locations on the I<sup>2</sup>C kit.
6. Write and read the registers:
  - a) Ensure that the I<sup>2</sup>C kit can communicate with the computer.
    - If the text “USB is not connected!” appears on the GUI, this means that the I<sup>2</sup>C kit cannot communicate with the computer (see Figure 1).
  - b) Once a connection has been established, use the drop-down menus to select the parameters.
  - c) When the parameters are set, send the data to the IC by clicking “WRITE ALL”.
  - d) Click the button “READ ALL” to see the data being written to the IC.

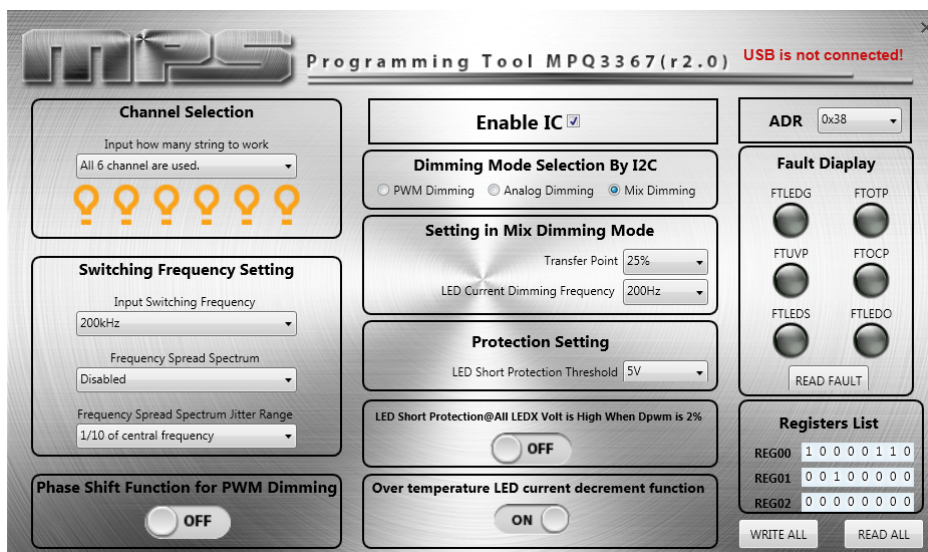

Figure 1: Unsuccessful Connection

### EVALUATION BOARD SCHEMATIC

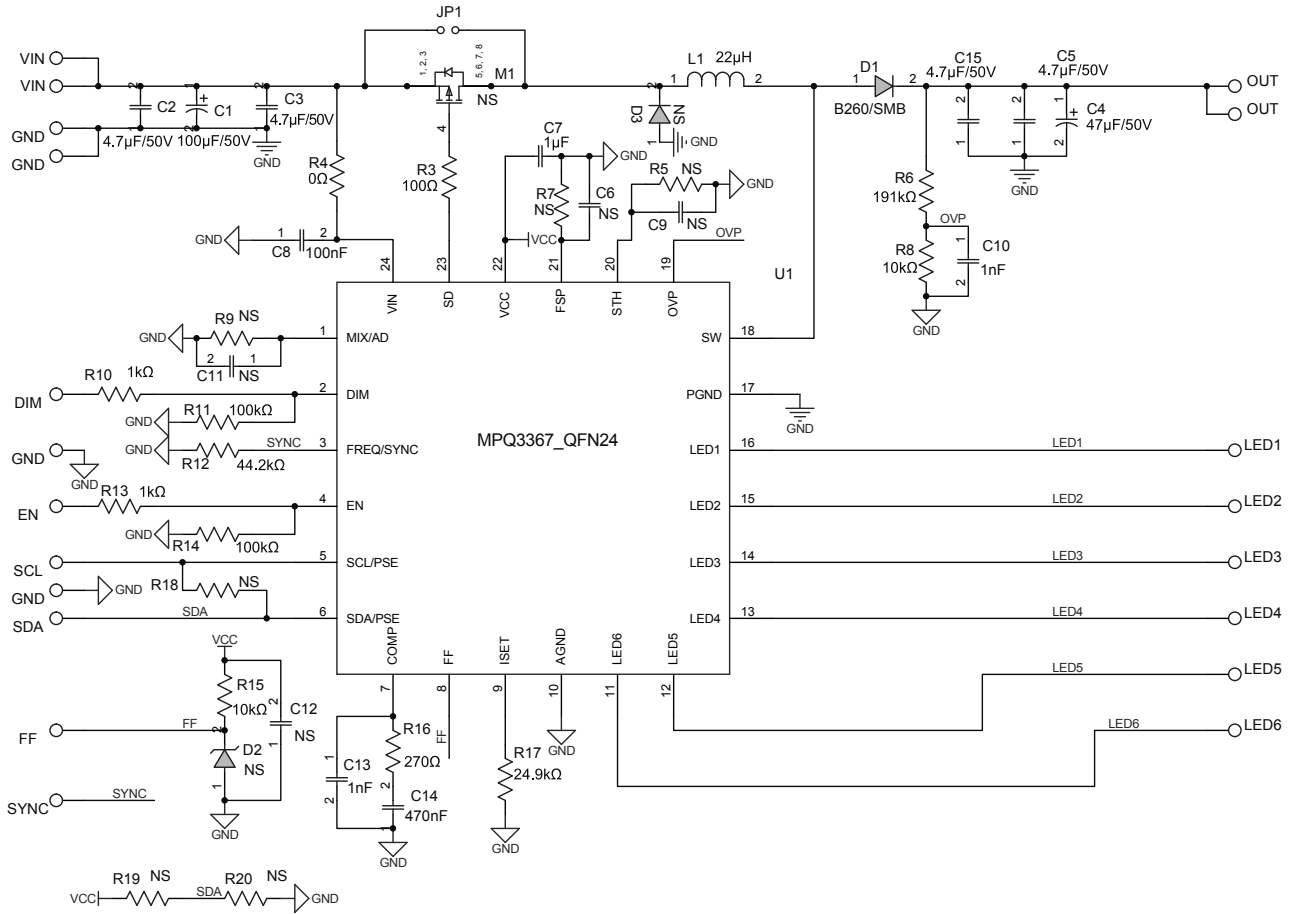

Figure 2: Typical Application for 6 Strings (12 LED in Series, 50mA/String)

**BILL OF MATERIALS**

Qty	Ref	Value	Description	Package	Manufacturer	Manufacturer P/N
1	C1	NC	Electrolytic capacitor, 100µF/50V	DIP		
4	C2, C3, C5, C15	4.7µF/50V	Ceramic capacitor, 50V, X7R, 1210	CAP/1210	MuRata	GRM32ER71H475KA88L
1	C4	NC	Electrolytic capacitor, 22µF/50V	DIP		
1	C7	1µF/25V	Ceramic capacitor, 25V, X7R	CAP/0805	MuRata	GRM216R61E105KA12D
1	C8	100nF/50V	Ceramic capacitor, 50V, X7R	CAP/0603	TDK	C1608X7R1H104K
4	C6, C9, C11, C12	NC		CAP/0603		
1	C10	100pF/10V	Ceramic capacitor, 50V, X7R	CAP/0603	MuRata	GRM1885C1H101JA01D
1	C13	1nF/10V	Ceramic capacitor, 16V, X7R	CAP/0603	MuRata	GRM188R71102KA01D
1	C14	470nF/10V	Ceramic capacitor, 16V, X7R	CAP/0603	TDK	C1608X7R1C474K
1	D1		Schottky diode, 60V, 2A	DIODES/SMB	Diodes	B260
1	D2	NC	Zener diode, 3.3V	DIODES/SOD-123		
1	D3	WSCD24H	Schottky diode, 40V, 2A	DIODES/SMA		WSCD24H
1	JP1	NC	Connector	CONN/DIP/2PIN/2.54MM/A		
1	L1	22µH	Inductor, 22µH, 77.6m, I <sub>SAT</sub> = 3A	IND/TOKO/D104C-919AS-220M	TOKO	D104C-919AS-220M
1	M1	AM4841P	P-channel MOSFET, -40V/9A	MOS/SO8	Analog Power	AM4841P
1	R1	NC	Film resistor, 5%	RES/1206		
6	R2, R4, R5, R7, R9, R18	NC	Film resistor, 1%	RES/0603		
1	R3	100Ω	Film resistor, 1%	RES/0603	Yageo	RC0603FR-07100RL
1	R4	0	Film resistor, 1%	RES/0603	Yageo	RC0603FR-070RL

**BILL OF MATERIALS** (continued)

Qty	Ref	Value	Description	Package	Manufacturer	Manufacturer P/N
1	R6	191k $\Omega$	Film resistor, 1%	RES/0603	Yageo	RC0603FR-07191KL
1	R8	10k $\Omega$	Film resistor, 1%	RES/0603	Yageo	RC0603FR-0710KL
2	R10, R13	1k $\Omega$	Film resistor, 1%	RES/0603	Yageo	RC0603FR-071KL
3	R11, R14, R15	100k $\Omega$	Film resistor, 1%	RES/0603	Yageo	RC0603FR-07100KL
1	R12	44.2k $\Omega$	Film resistor, 1%	RES/0603	Yageo	RC0603FR-0744K2L
1	R16	270 $\Omega$	Film resistor, 1%	RES/0603	Yageo	RC0603FR-07270RL
1	R17	24.9k $\Omega$	Film resistor, 1%	RES/0603	Yageo	RC0603FR-0724K9L
1	U1	MP3367	6-channel boost WLED driver with I <sup>2</sup> C	QFN-24	MPS	MP3367GR

## EVB TEST RESULTS

Performance waveforms are tested on the evaluation board.  $V_{IN} = 12V$ ,  $L = 22\mu H$ , LED = 6P12S,  $f_{sw} = 400kHz$ ,  $I_{SET} = 50mA$ ,  $T_A = 25^\circ C$ , unless otherwise noted.

### Steady State

$f_{sw} = 400kHz$

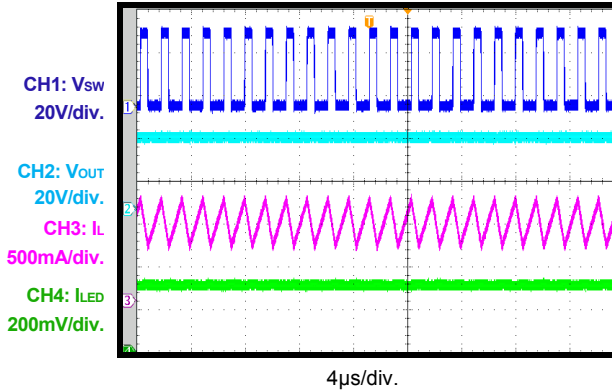

### Steady State

$f_{sw} = 2.2MHz$

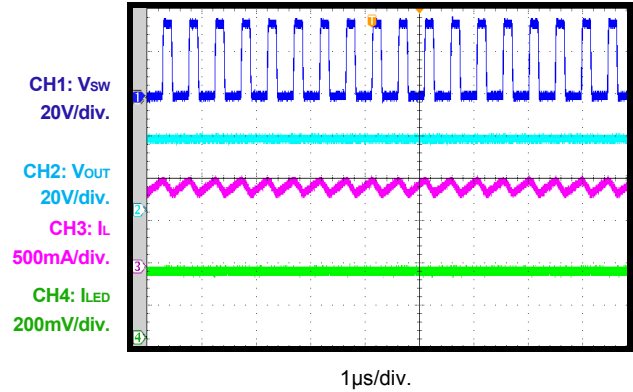

### VIN Power On

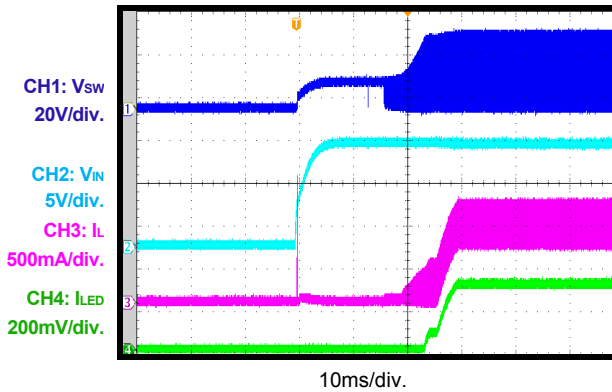

### EN Power On

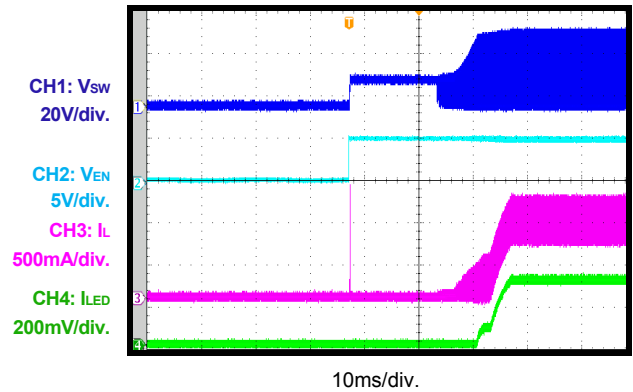

### PWM Dimming

$f_{PWM} = 200Hz$ ,  $D_{PWM} = 50\%$

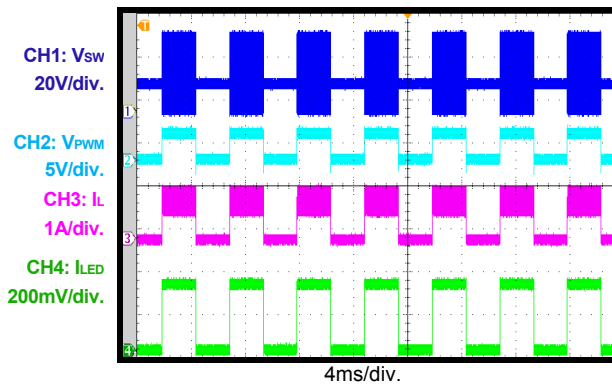

### PWM Dimming

$f_{PWM} = 20kHz$ ,  $D_{PWM} = 50\%$

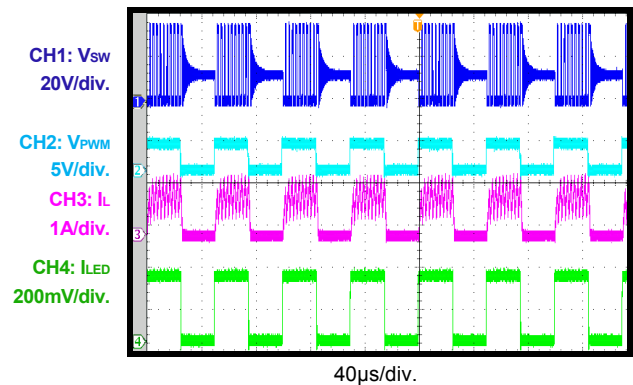



### EVB TEST RESULTS (continued)

Performance waveforms are tested on the evaluation board.  $V_{IN} = 12V$ ,  $L = 22\mu H$ , LED = 6P12S,  $f_{sw} = 400kHz$ ,  $I_{SET} = 50mA$ ,  $T_A = 25^\circ C$ , unless otherwise noted.

#### PWM Dimming

$f_{PWM} = 200Hz$ ,  $D_{PWM} = 0.01\%$

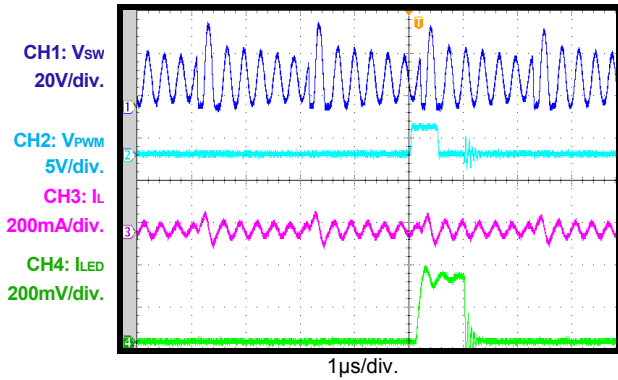

#### PWM Dimming

$f_{PWM} = 200Hz$ ,  $D_{PWM} = 0.001\%$

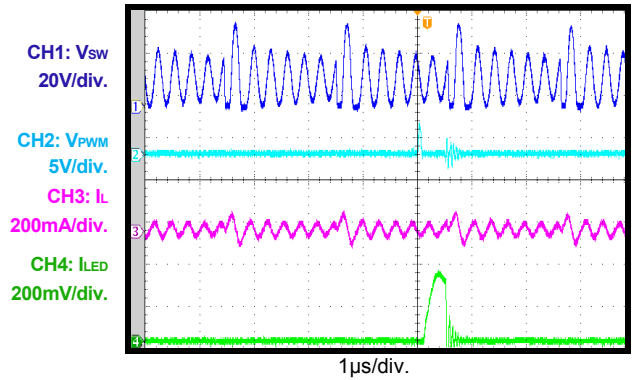

#### Mix Dimming

$f_{PWM} = f_{ILED} = 200Hz$ ,  $D_{PWM} = 10\%$

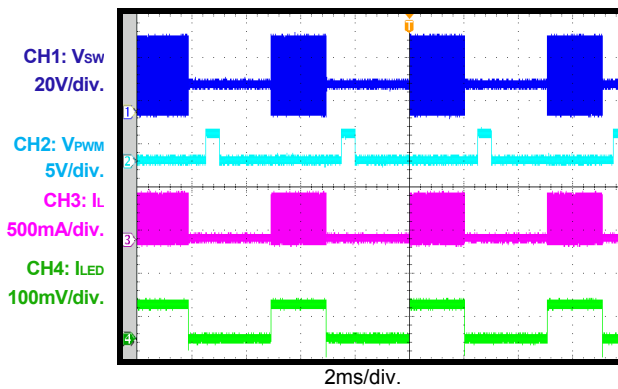

#### Mix Dimming

$f_{PWM} = 200Hz$ ,  $f_{ILED} = 23kHz$ ,  $D_{PWM} = 10\%$

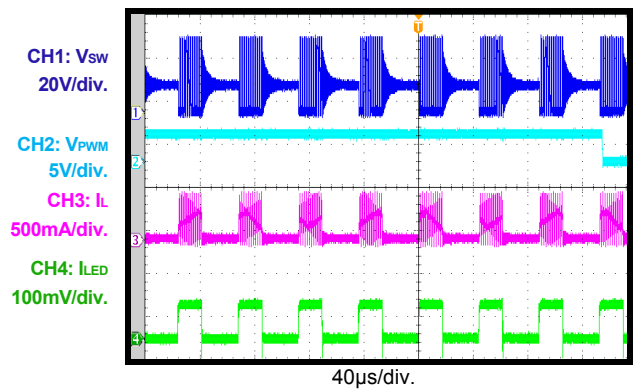

#### Phase Shift Function

$f_{PWM} = 200Hz$ , PWM Dimming, 6 channel enable

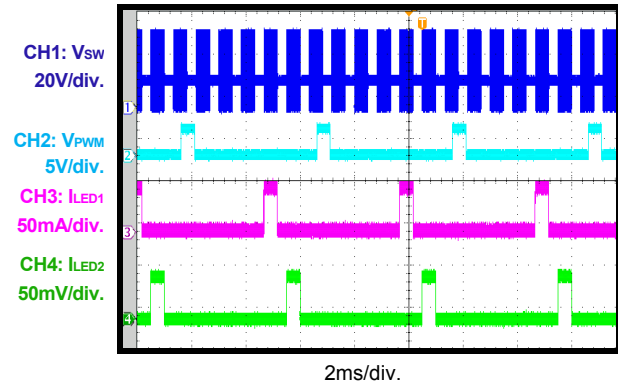

#### Frequency Spread Spectrum

$f_{PWM} = 400Hz$ , 1/100 of center frequency

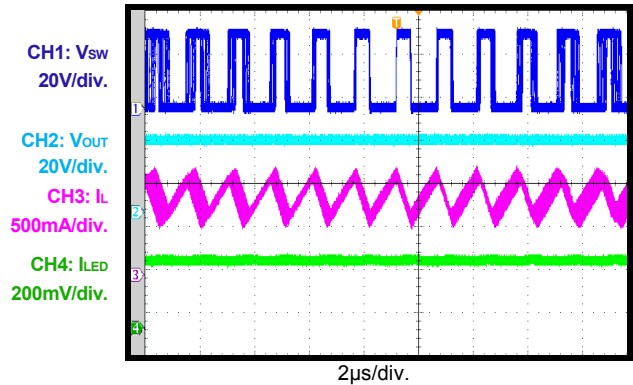



### EVB TEST RESULTS (continued)

Performance waveforms are tested on the evaluation board.  $V_{IN} = 12V$ ,  $L = 22\mu H$ , LED = 6P12S,  $f_{sw} = 400kHz$ ,  $I_{SET} = 50mA$ ,  $T_A = 25^\circ C$ , unless otherwise noted.

#### Open LED Protection Open one string when working

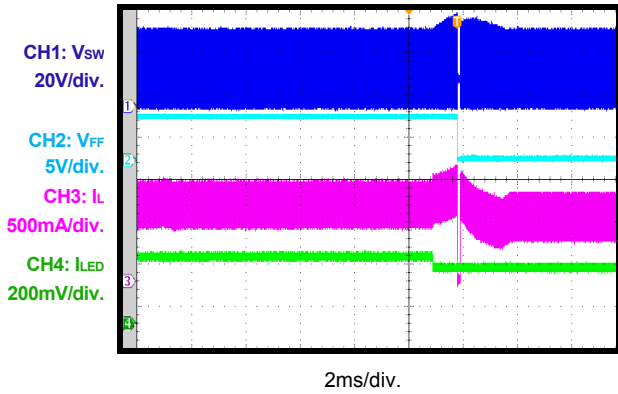

#### LED Short Protection Short one string when working

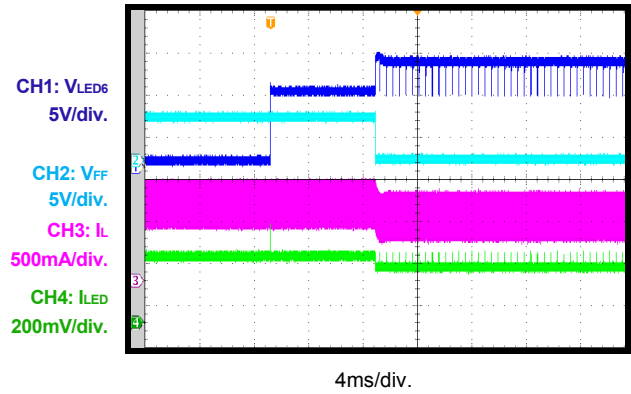

#### Inductor Short Protection

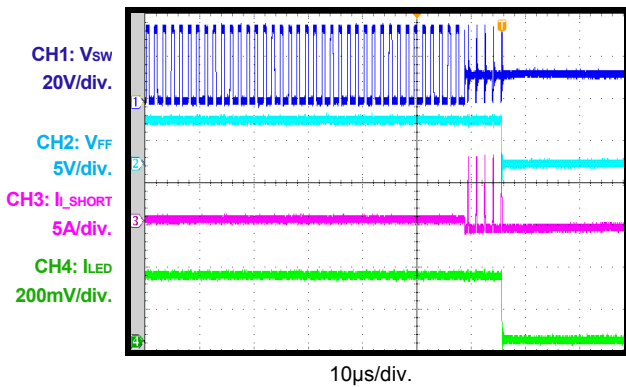

#### Diode Short Protection

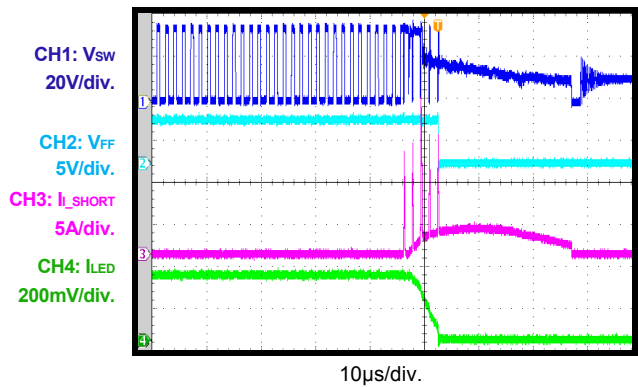

#### VOUT-to-GND Short Protection

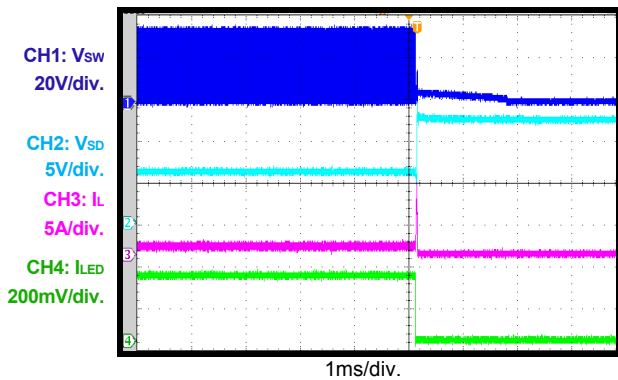

#### Thermal Shutdown Protection

$f_{PWM} = 400Hz$ , 1/100 of center frequency

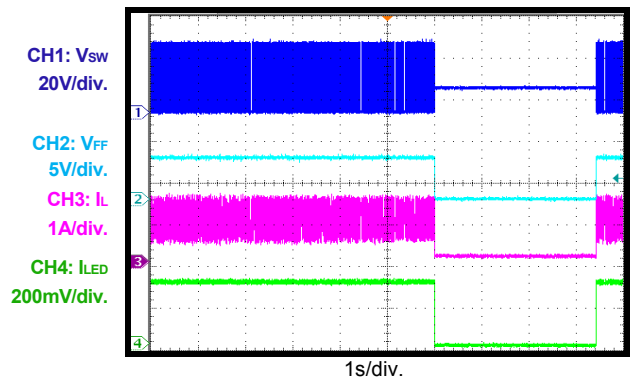

PCB LAYOUT

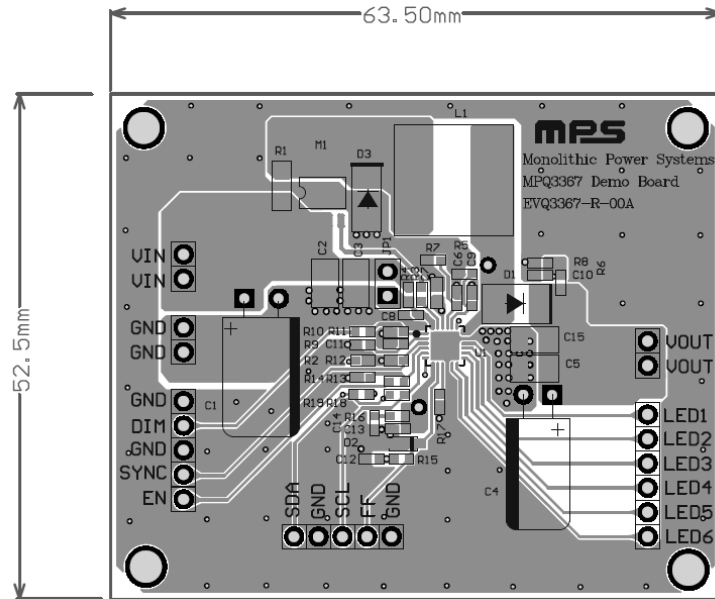

Figure 3: Top Layer

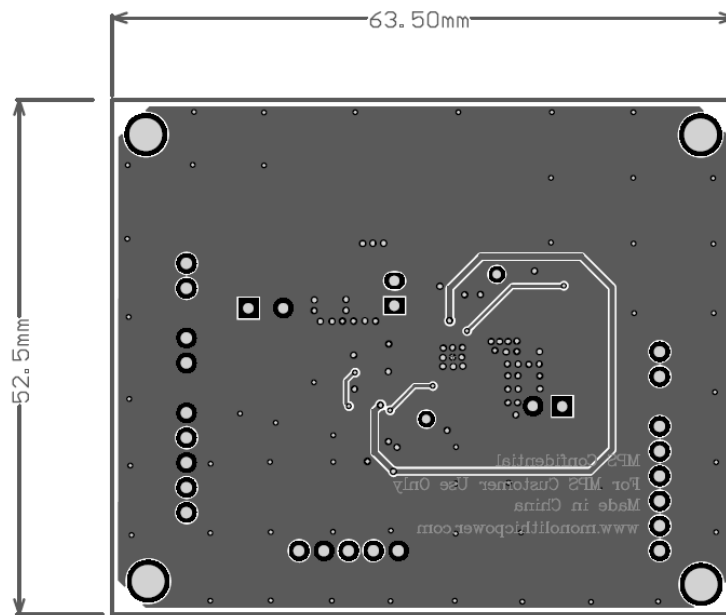

Figure 4: Bottom Layer

**Notice:** The information in this document is subject to change without notice. Please contact MPS for current specifications. Users should warrant and guarantee that third-party Intellectual Property rights are not infringed upon when integrating MPS products into any application. MPS will not assume any legal responsibility for any said applications.