

### DESCRIPTION

The MP3376 is a synchronous boost converter with 8 current channels designed to drive WLED arrays for LCD-panel in tablet and notebook backlighting applications.

The MP3376 uses peak-current mode and PWM control to maintain boost converter regulation. The MP3376 employs a standard I<sup>2</sup>C digital interface to set operation mode, switching frequency, full-scale current for each channel, sync or non-sync mode, dimming mode and duty, and various protection thresholds.

MP3376 features high efficiency with small on resistance of switching MOSFET. In addition, the synchronous rectifier saves PCB size and total BOM cost.

The MP3376 is available in QFN24 (4mmX4mm) package.

### ELECTRICAL SPECIFICATIONS

Parameter	Symbol	Value	Units
Input Voltage	V <sub>IN</sub>	3 – 30	V
Output Voltage	V <sub>LED</sub>	<=34.5	V
LEDs #		8 string	
LED Current	I <sub>LED</sub>	MAX:50/string	mA

### FEATURES

- 8-Channel with Max. 50mA/Channel
- Synchronous Converter with LS-FET/HS-FET 160m/260mΩ on Resistance
- 3V to 30V Input Voltage Range
- Up to 36V Output Voltage
- Max 2.5% Current Matching
- 350k / 500k / 650k / 800k / 950k / 1.2M / 1.8M / 2.4MHz Selectable Switching Frequency
- A0, A1 Pins for 4 PCS IC Selection
- 0mA to 50mA Full Scale Current Set, 8-bit, 0.196mA/step
- Selectable Sync or Non-Sync Mode
- Multi-Dimming Operation Mode Including:
  1. Analog Dimming Mode through External PWM Input
  2. Analog Dimming Mode through I<sup>2</sup>C interface
  3. Mix dimming Mode through External PWM Input with 6.25% / 12.5% / 25% / 50% Transfer Point
  4. Mix Dimming Mode through I<sup>2</sup>C Interface with 6.25% / 12.5% / 25% / 50% Transfer Point
- Customizable Default Register Values
- Linear smooth dimming with 2 / 4 / 8 / 16 / 32 / 64 / 128us for per step-slope set
- Unused LED string auto disable during Startup
- LED short/open, OTP, OCP, Inductor or Diode Short Protection
  - 2.5 / 5 / 7.5 / 10V LED Short Threshold
  - 24 / 31 / 36V OVP Threshold
  - 1.8 / 2.5A Cycle by Cycle Current Limit
- Free for Adjacent Pin Short Test
- Available in QFN24 (4mmX4mm) package

### APPLICATIONS

- Tablet/Notebook
- Auto-motive Display

All MPS parts are lead-free, halogen free, and adhere to the RoHS directive. For MPS green status, please visit MPS website under Quality Assurance. "MPS" and "The Future of Analog IC Technology" are Registered Trademarks of Monolithic Power Systems, Inc.

## EV3376-R-00A EVALUATION BOARD

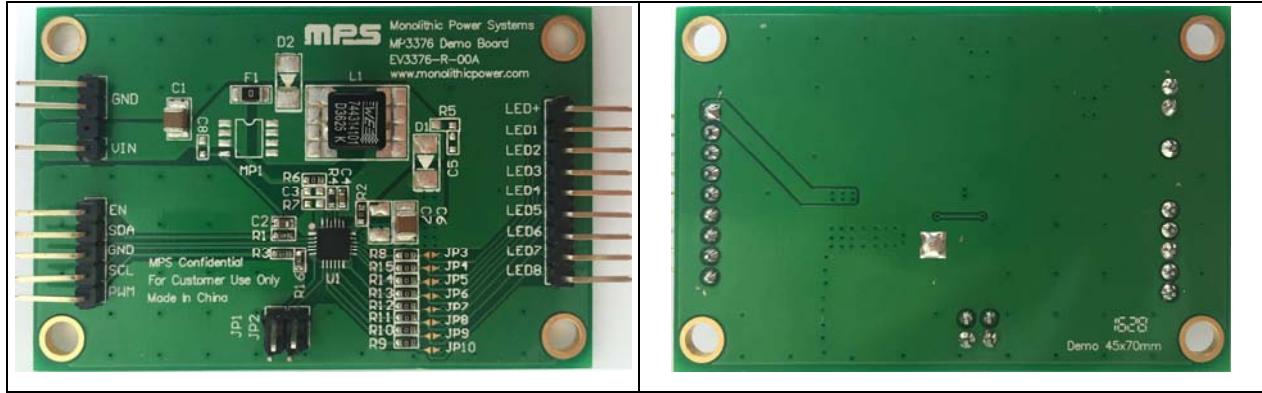

(L x W x H) 7cm x 4.5cm x 0.6cm

Board Number	MPS IC Number
EV3376-R-00A	MP3376GR

## EVALUATION BOARD SCHEMATIC

MP1: Optional for short Vout to GND pin

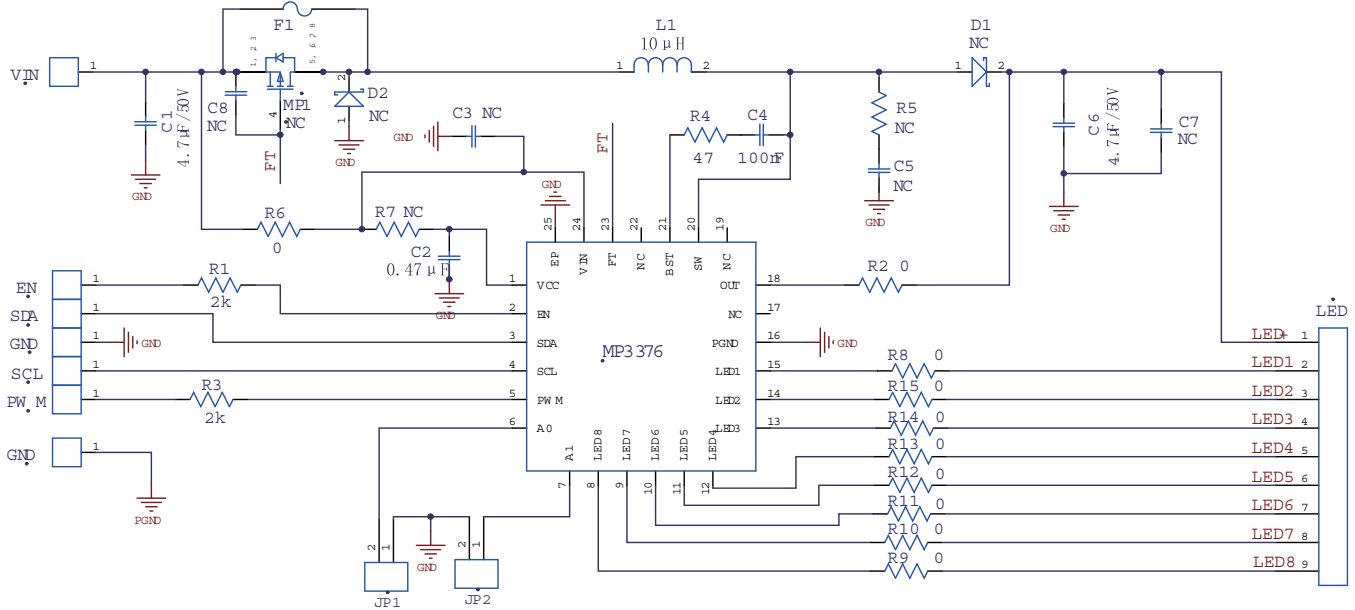

**EV3376-R-00A BILL OF MATERIALS**

Qty	Ref	Value	Description	Package	Manufacturer	Part Number
1	F1	0Ω	Fuse or Res	1206	muRata	RC1206JR-070RL
1	MP1	NC	PMOS	SO-8		
2	C1,C6	4.7μF	Ceramic Capacitor, 50V, X7R	1210	muRata	GRM32ER71H475KA88L
1	C7	NC	Ceramic Capacitor, 50V	1210		
1	C2	470nF	Ceramic Capacitor, 16V, X7R	0603	muRata	GRM188R71C474KA88D
1	C3	NC	Ceramic Capacitor, 50V	0603		
1	C4	100nF	Ceramic Capacitor, 16V, X7R	0603	muRata	GRM188R71C104KA01D
2	C5,C8	NC	Ceramic Capacitor, 50V	0603		
1	D1	NC	B160	SMA		
1	D2	NC		SMA		
1	L1	10μH	Inductor, 33mΩ,3.5A	SMD	Würth	744314101
2	R1,R3	2.1kΩ	Resistor, 2.1kΩ, 1%	0603	Yageo	RC0603FR-072K1L
10	R2,R6, R8~R15	0Ω	Resistor, 0Ω, 1%	0603	Yageo	RC0603FR-070RL
1	R4	47Ω	Resistor, 47Ω, 1%	0603	Yageo	RC0603FR-0747RL
2	R5,R7	NC	Resistor	0603		
1	R16	100kΩ	Resistor, 100kΩ, 1%	0603	Yageo	RC0603FR-07100KL
1	U1	MP3376	LED driver with I2C interface	QFN24 (4*4mm)	MPS	R5

## EVB TEST RESULTS

Performance waveforms are tested on the evaluation board.

$V_{IN} = 7V$ , 8 LEDs in series, 8 strings, 20mA/string,  $L = 4.7\mu H$ ,  $T_A = 25^\circ C$ , unless otherwise noted.

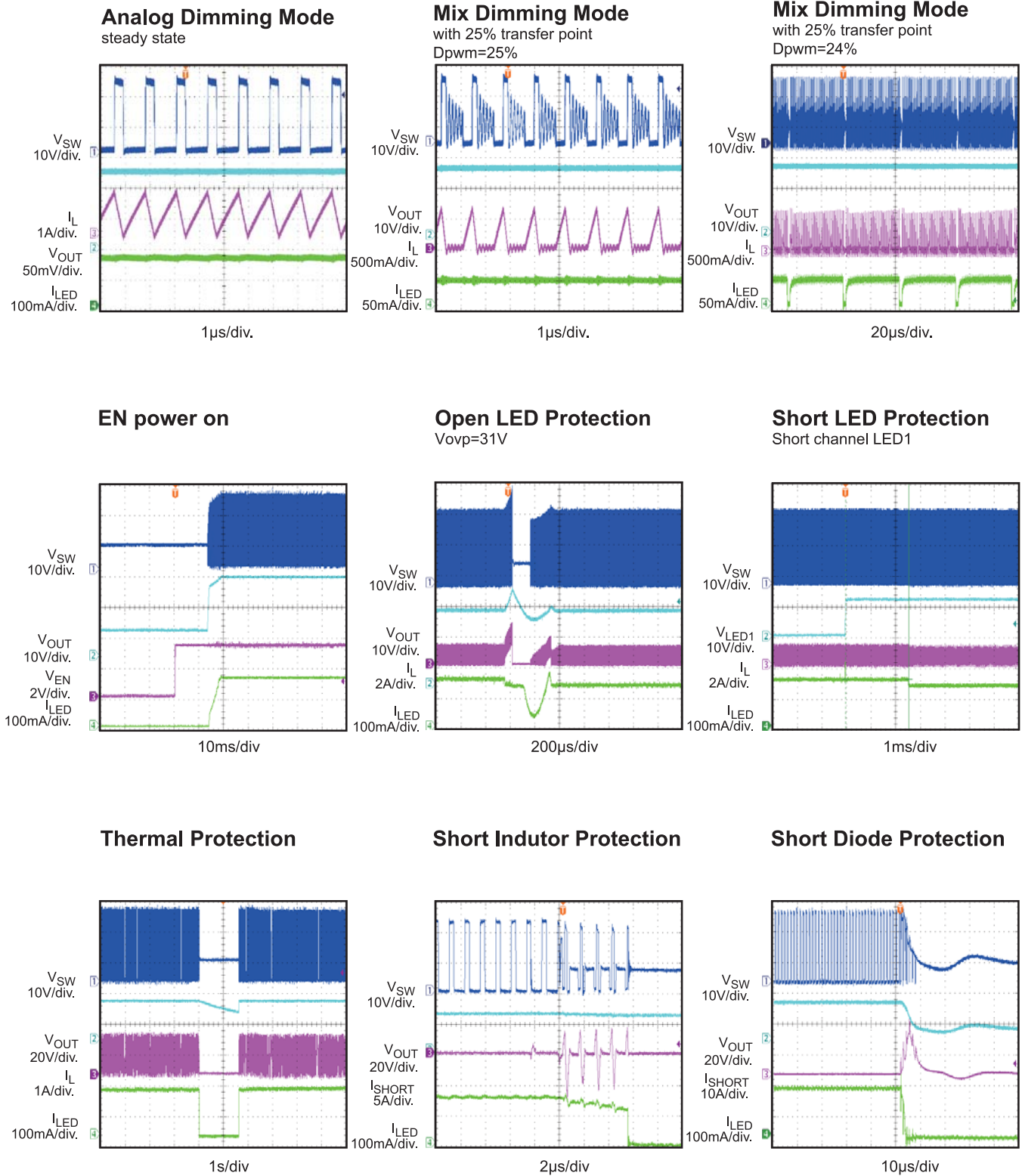

### PRINTED CIRCUIT BOARD LAYOUT

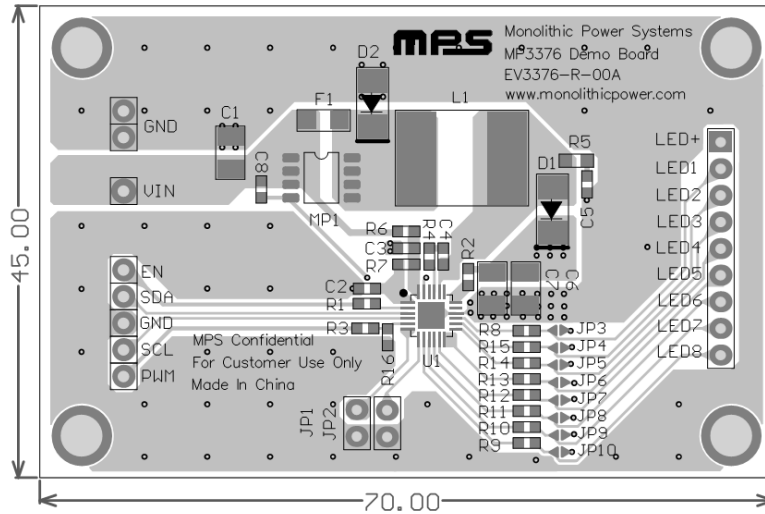

Figure 1—Top Layer

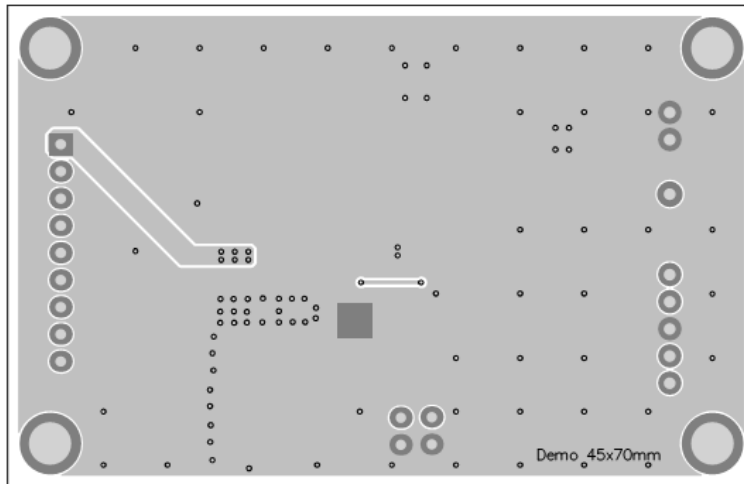
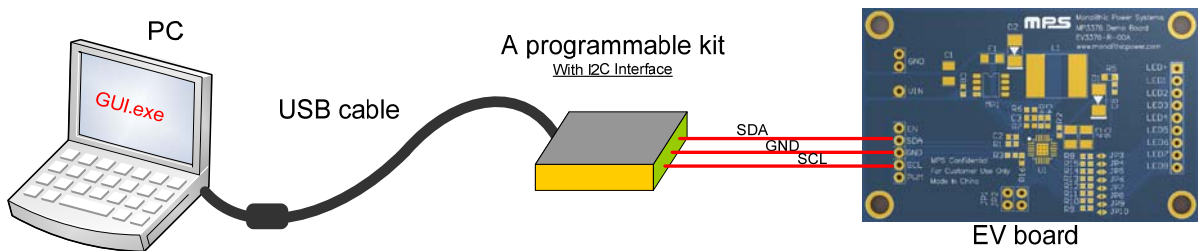

Figure 2—Bottom Layer

## QUICK START GUIDE

### Signal connection:

1. Connect the positive and negative terminals of the power supply (3V ~ 30V) to the VIN and GND pins on the EV board, respectively.
2. Connect the positive and negative terminals of the load panel (8 strings) to the Vout and LED1~8 pins on the EV board, respectively. For unused string, it is recommended to connect the unused LEDX pin to GND by a 0Ω resistor.
3. Connect EN pin to enable signal(High level>1.5V).
4. Please connect SCL, SDA and GND of EV board to SCL, SDA and GND of a programmable kit with I<sup>2</sup>C interface, respectively, as picture 3 shows.
5. If work in external dimming mode, please add PWM input signal to PWM terminal on the EV board. If work in internal dimming mode, nothing is need for PWM pin or pull PWM pin to GND.



Picture 3—I<sup>2</sup>C Connection Diagram

### Power on sequence:

1. Vin power on
2. EN power on
3. Setting Register by I2C interface as picture 4 shows: (Refer to the “GUI user guide” in another file.)
4. PWM signal on and the LED string should be ignited. Program the PWM duty cycle to dim the LED current.

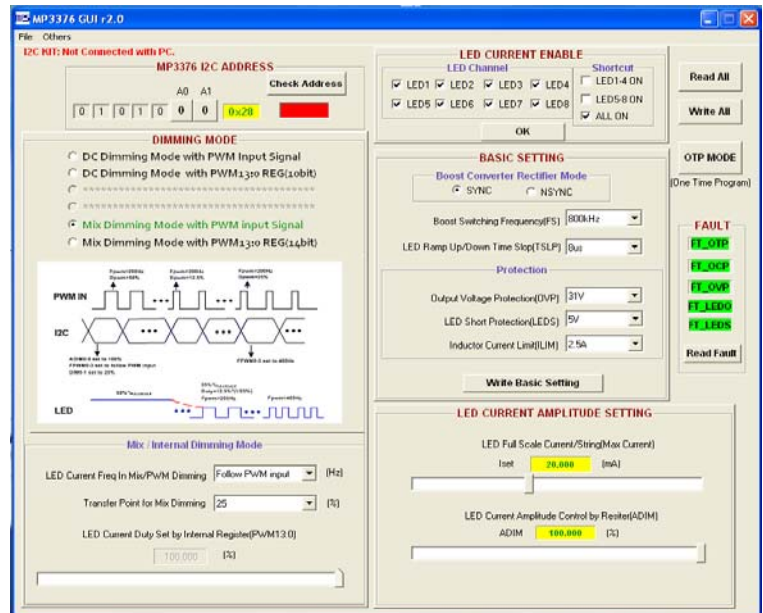

Picture 4—MP3376 GUI Interface

**NOTICE:** The information in this document is subject to change without notice. Please contact MPS for current specifications. Users should warrant and guarantee that third party Intellectual Property rights are not infringed upon when integrating MPS products into any application. MPS will not assume any legal responsibility for any said applications.