

### DESCRIPTION

The EV3393-F-00A is an evaluation board for the MP3393, a step-up controller with 8-channel external-transistor current sources.

The MP3393 uses current mode, fixed frequency architecture. It drives an external MOSFET to boost up the output voltage from 9V to 32V input supply. The switching frequency is programmable by an external setting resistor.

The MP3393 integrates the constant current control circuit to regulate the current in each LED string to the value set by an external current feedback resistor. And the current matching can achieve 1.2% regulation accuracy between strings. Its low 202mV regulation voltage on LED current sources reduces power loss and improves efficiency.

The EV3393-F-00A is a fully assembled and tested PCB. It generates a 1.6A (200mA/string, 8 strings) output current at LED load from a 12V to 30V input range. Switching frequency is set at 160kHz.

### ELECTRICAL SPECIFICATIONS

Parameter	Symbol	Value	Units
Input Voltage	$V_{IN}$	12 – 30	V
Output Voltage	$V_{OUT}$	$>V_{IN}$	V
Output Current	$I_{OUT}$	200*8	mA

### FEATURES

- 9V to 32V Input Voltage Range
- Drive 8 Channels LED strings
- Internal Constant Current Control
- Maximum Channel Current Over 350mA
- 1.2% Current Matching Accuracy Between Strings
- Programmable Switching Frequency
- Analog Dimming and External PWM Dimming
- Open and Short LED Protection
- Programmable Over-voltage Protection
- Fault Flag Output
- Thermal Shutdown
- Extendable LED Channels with Share One Set of Power Stage
- 28-pin TSSOP and 28-pin SOIC Packages

### APPLICATIONS

- Desktop LCD Flat Panel Displays
- Flat Panel Video Displays
- LCD TVs and Monitors

All MPS parts are lead-free and adhere to the RoHS directive. For MPS green status, please visit MPS website under Quality Assurance. "MPS" and "The Future of Analog IC Technology" are Registered Trademarks of Monolithic Power Systems, Inc.

### EV3393-F-00A EVALUATION BOARD



(L x W x H)  
(13.1cm x 8.7cm x 1.0cm)

Board Number	MPS IC Number
EV3393-F-00A	MP3393EF

Efficiency vs.  $V_{IN}$

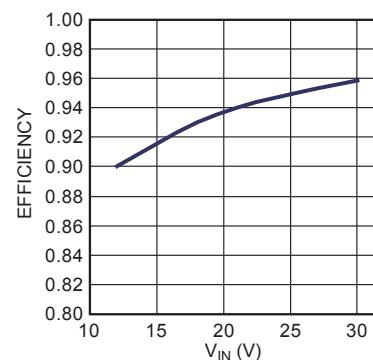

EVALUATION BOARD SCHEMATIC

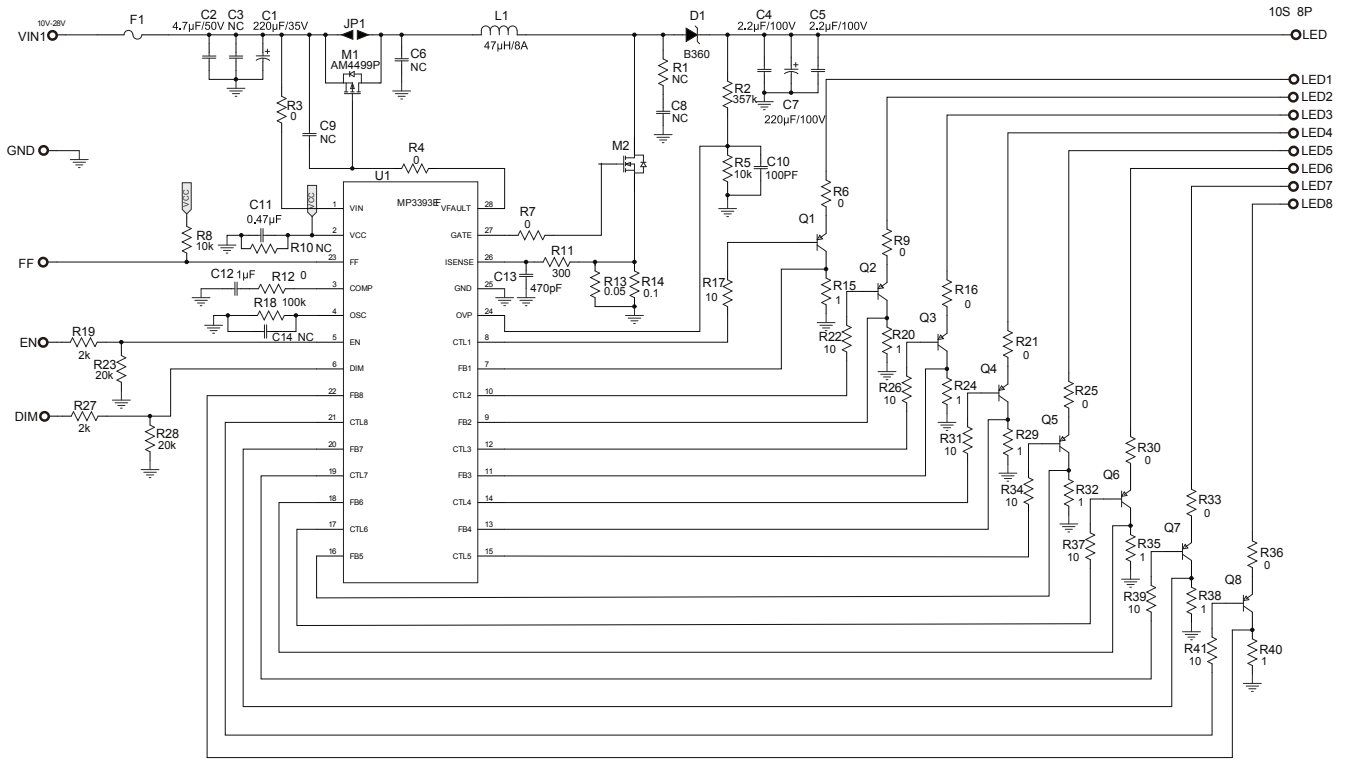

**EV3393-F-00A BILL OF MATERIALS**

Qty	Ref	Value	Description	Package	Manufacturer	Part Number
1	C1	220 $\mu$ F	Electrolytic Capacitor, 35V	DIP	江海	CD110-35V220
1	C2	4.7 $\mu$ F	Ceramic Capacitor, 50V, X7R	1210	Murata	GRM32ER71H475KA88L
2	C3, C6	NC		1210		
2	C4, C5	2.2 $\mu$ F	Ceramic Capacitor, 100V, X7R	1210	Murata	GRM32ER72A225KA35L
1	C7	220 $\mu$ F	Electrolytic Capacitor, 63V	DIP	Panasonic	EEU-FC1J221X
1	C14	NC		0603		
1	C9	4.7nF	Ceramic Capacitor, 50V, X7R	0603	Murata	GRM188R71H472KA01D
1	C10	100pF	Ceramic Capacitor, 50V, COG	0603	Murata	GRM1885C1H101JA01
1	C11	0.47 $\mu$ F	Ceramic Capacitor, 25V, X7R	0603	Murata	GRM188R71EH474LKA12
1	C12	1 $\mu$ F	Ceramic Capacitor, 25V, X7R	0603	Murata	GRM188R71E105KA12
2	C13, C8	470pF	Ceramic Capacitor, 50V, COG	0603	Murata	GRM1885C1H471JA01
2	D1, D2		Diode Schottky, 60V, 3A	SMA	Diodes Inc	B360
1	F1	0 $\Omega$	Fuse, 4A, 63V	1206	Cooper Bussman	CC12H4A
1	L1	47 $\mu$ H	Inductor, 6.8A	SMD	Würth	74435574700
1	M1		P- channel MOSFET	SO8	Analog Power	AM4499P
1	M2		N- channel MOSFET	TO-263	Vishay	SUM110N15-1XP
8	Q1-Q8		PNP, Transistor, -100V, -5A	SOT223	Zetex	FZT953TA
1	R2	357k $\Omega$	Resistor, 1%	0603	Yageo	RC0603FR-07357KL
1	R10	NC		0603		
11	R3, R4, R6, R9, R12, R16, R21, R25, R30, R33, R36	0 $\Omega$	Resistor, 1%	0603	Yageo	RC0603JR-070RL
2	R5, R8	10k $\Omega$	Resistor, 1%	0603	Yageo	RC0603FR-0710KL
1	R11	300 $\Omega$	Resistor, 1%	0603	Yageo	RC0603FR-07300RL
1	R13	0.05 $\Omega$	Current Resistor, 1%	2512	CYNTEC	RL3264-6-R050-FN
1	R14	0.1 $\Omega$	Current Resistor, 1%	2512	CYNTEC	RL3264-6-R100-FN

**EV3393-F-00A BILL OF MATERIALS** *(continued)*

Qty	Ref	Value	Description	Package	Manufacturer	Part Number
8	R15, R20, R29, R32, R35, R40, R24, R38	1Ω	Resistor, 1%	1206	Yageo	RC1206FR-071RL
1	R1	100Ω	Resistor, 5%	1206	Yageo	RC1206JR-07100RL
9	R7, R17, R22, R26, R31, R34, R37, R39, R41	10Ω	Resistor, 1%	0603	Yageo	RC0603FR-0710RL
1	R18	100kΩ	Resistor, 1%	0603	Yageo	RC0603FR-07100KL
2	R19,R27	2kΩ	Resistor, 1%	0603	Yageo	RC0603FR-072KL
2	R23,R28	20kΩ	Resistor, 1%	0603	Yageo	RC0603FR-0720KL
1	U1		LED Driver IC	TSSOP2	MPS	MP3393EF R1

## EVB TEST RESULTS

Performance waveforms are tested on the evaluation board.

$V_{IN} = 18V$ , 10 LEDs in series, 8 strings parallel, 200mA/string, unless otherwise noted.

Steady State

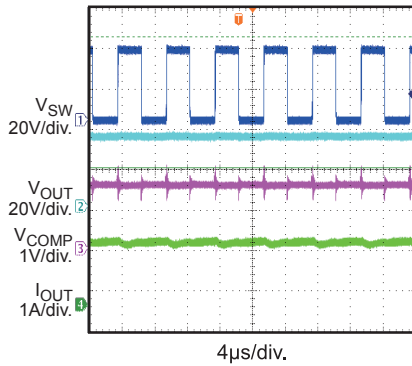

$V_{IN}$  Power On

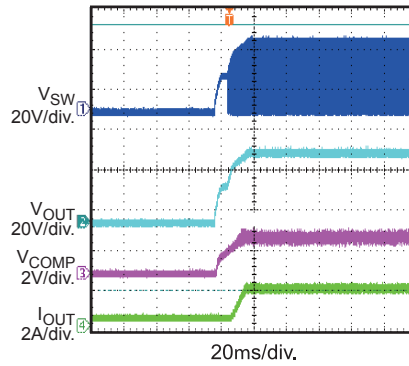

EN Power On

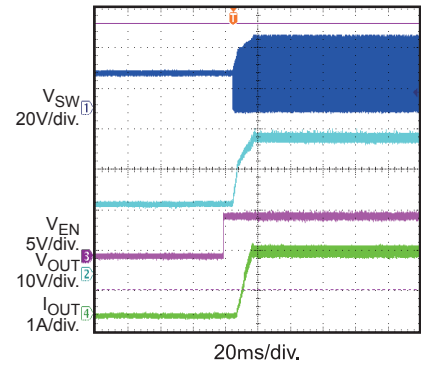

PWM Dimming

200Hz 50% PWM Dimming

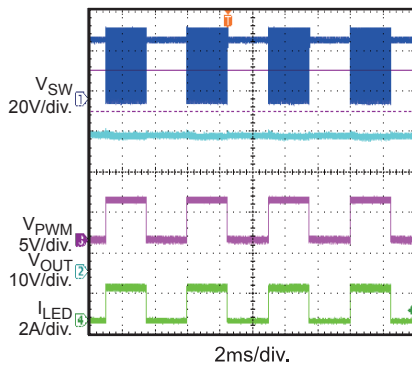

DC Dimming

$V_{DIM} = 0.8V$

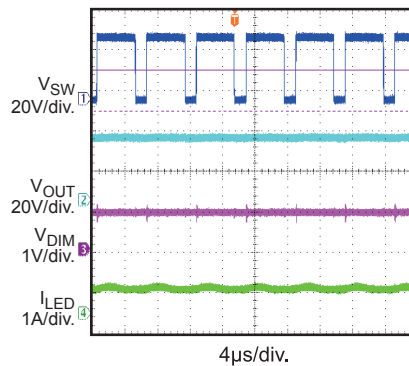

Open all Load

@ Working Normally

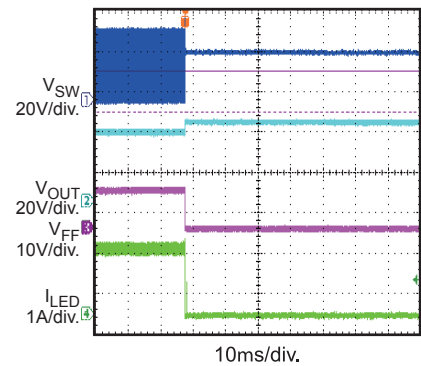

Open a String

@ Working Normally

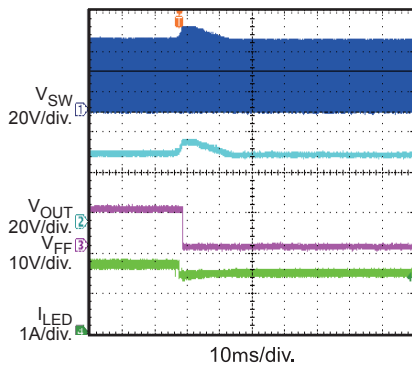

Short a String

@ Working Normally

$V_B$  is base pole of external NPN transistor in the short string

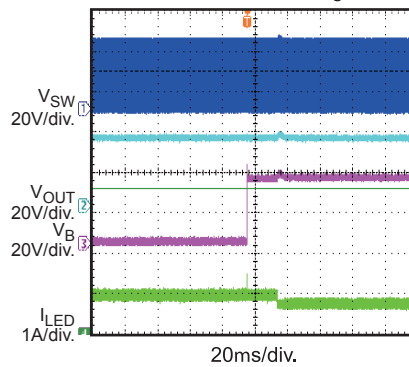

Short  $V_{OUT}$  to GND

@ Working Normally

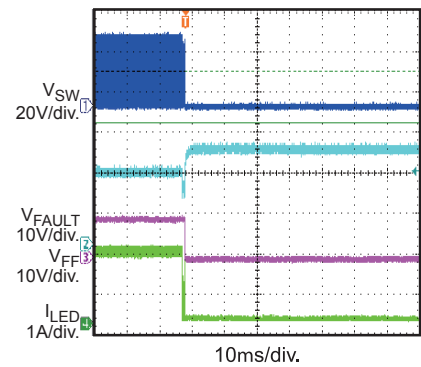

**PRINTED CIRCUIT BOARD LAYOUT**

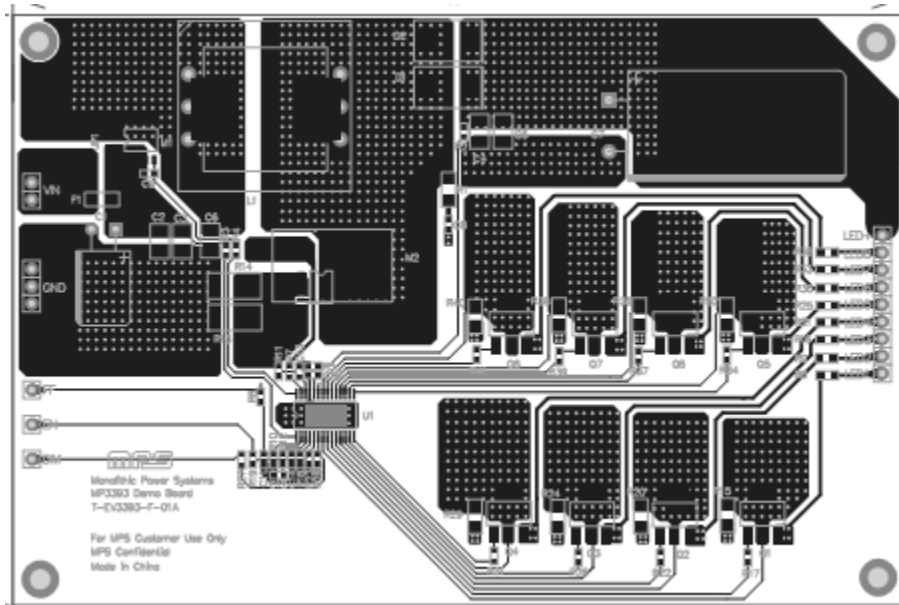

**Figure1 Top Layer**

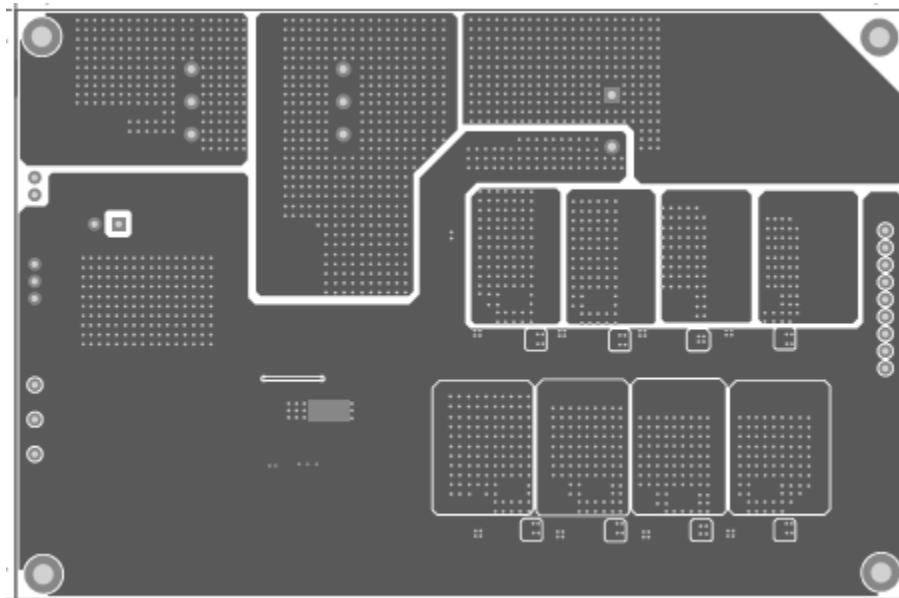

**Figure2 Bottom Layer**

## QUICK START GUIDE

1. Connect the positive terminals of 8-string LED load and LED+ port together. Then connect the negative terminals of 1-8 LED strings to LED1-8 port respectively.
2. Preset the power supply output to between 12 and 30V, and then turn it off.
3. Connect the positive and negative terminals of the power supply output to the VIN and GND ports, respectively.
4. Connect +5V to EN and DIM ports. If PWM dimming is required, put a 100-200Hz PWM signal on DIM port.
5. Output over voltage protection (OVP) function is implemented by the addition of a resistor divider R2 and R5. The OVP threshold is 1.23V. When  $V_{OUT}$  exceeds  $1.23 \times (1 + R2/R5)$ , the OVP is triggered. It is preset to 45V on this board.
6. Use R15, R20, R24, R29, R32, R35, R38 and R40 to set output current for each string. On the demo board, they are  $1\Omega$ . The output current is  $(0.202/1) \approx 0.2A/string$ .

**NOTICE:** The information in this document is subject to change without notice. Users should warrant and guarantee that third party Intellectual Property rights are not infringed upon when integrating MPS products into any application. MPS will not assume any legal responsibility for any said applications.