

DESCRIPTION

The MP3398E is a step-up controller with four current channels designed to drive WLED arrays for large size LCD panel backlighting applications. The MP3398E is able to expand the number of LED channels with two or more ICs in parallel sharing a single power source.

The MP3398E employs peak-current mode with a fixed switching frequency. The frequency is programmable through an external setting resistor. The MP3398E drives an external MOSFET to boost up the output voltage from a 4.5V to 33V input supply and regulates the current in each LED string to the value set by an external current-setting resistor.

The MP3398E applies four internal current sources for current balancing. The current matching achieves 2.3% regulation accuracy between strings. The low regulation voltage on the LED current sources reduces power loss.

The MP3398E supports direct PWM dimming and analog dimming with PWM input. Full protection features include over-current protection (OCP), Over-temperature protection (OTP), Under-voltage protection (UVP), over-voltage protection (OVP), LED short/open protection, and inductor/diode short protection.

The MP3398E is available in TSSOP-16EP and PDIP-16 packages.

ELECTRICAL SPECIFICATIONS

Parameter	Symbol	Value	Units
Input Voltage	V_{IN}	13 – 33	V
LEDs #		4 LED strings 20 LEDs/string	
LED Current	I_{LED}	120/string	mA

FEATURES

- 4-String, Max 400mA/String WLED Driver
- 4.5V to 33V Input Voltage Range
- 80V ABS. Rating for Each String
- 2.3% Current Matching Accuracy Between Each String
- Direct PWM Dimming Mode
- Analog Dimming Mode with PWM Input
- Cascading Capability with a Single Power Source
- LED Open and Short Protection
- Programmable Recoverable Over-Voltage Protection (OVP)
- 202mV Latch-off Cycle-by-Cycle Current Limit Threshold
- Latch-Off Over-Temperature Protection (OTP)
- Available in TSSOP-16EP and PDIP-16 Packages

APPLICATIONS

- Desktop LCD Flat Panel Displays
- All-in-one PCs
- 2D/3D LCD TVs

All MPS parts are lead-free, halogen free, and adhere to the RoHS directive. For MPS green status, please visit MPS website under Quality Assurance. "MPS" and "The Future of Analog IC Technology" are Registered Trademarks of Monolithic Power Systems, Inc.

EV3398E-U-00A EVALUATION BOARD

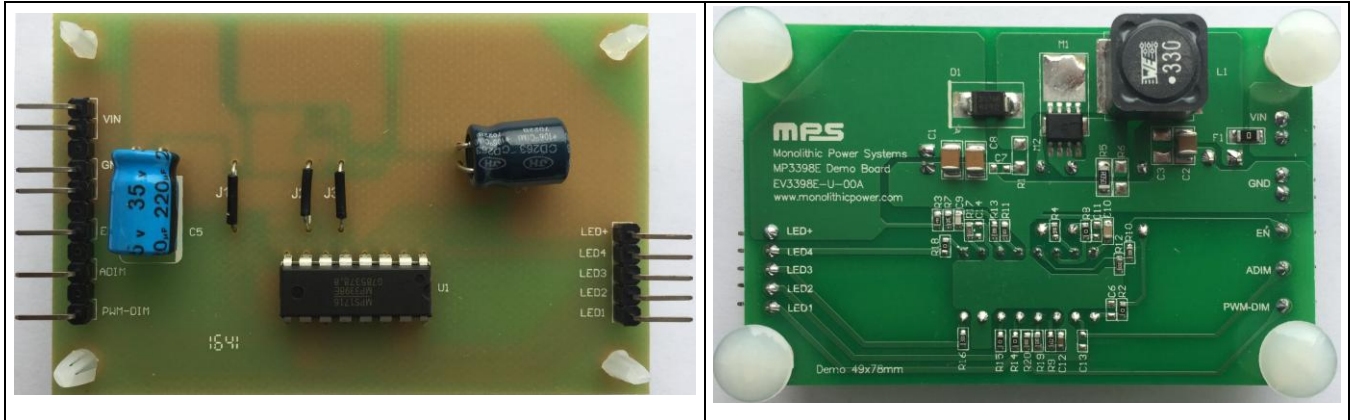

(L x W) 7.75cm x 4.88cm

Board Number	MPS IC Number
EV3398E-U-00A	MP3398EGP

EVALUATION BOARD SCHEMATIC

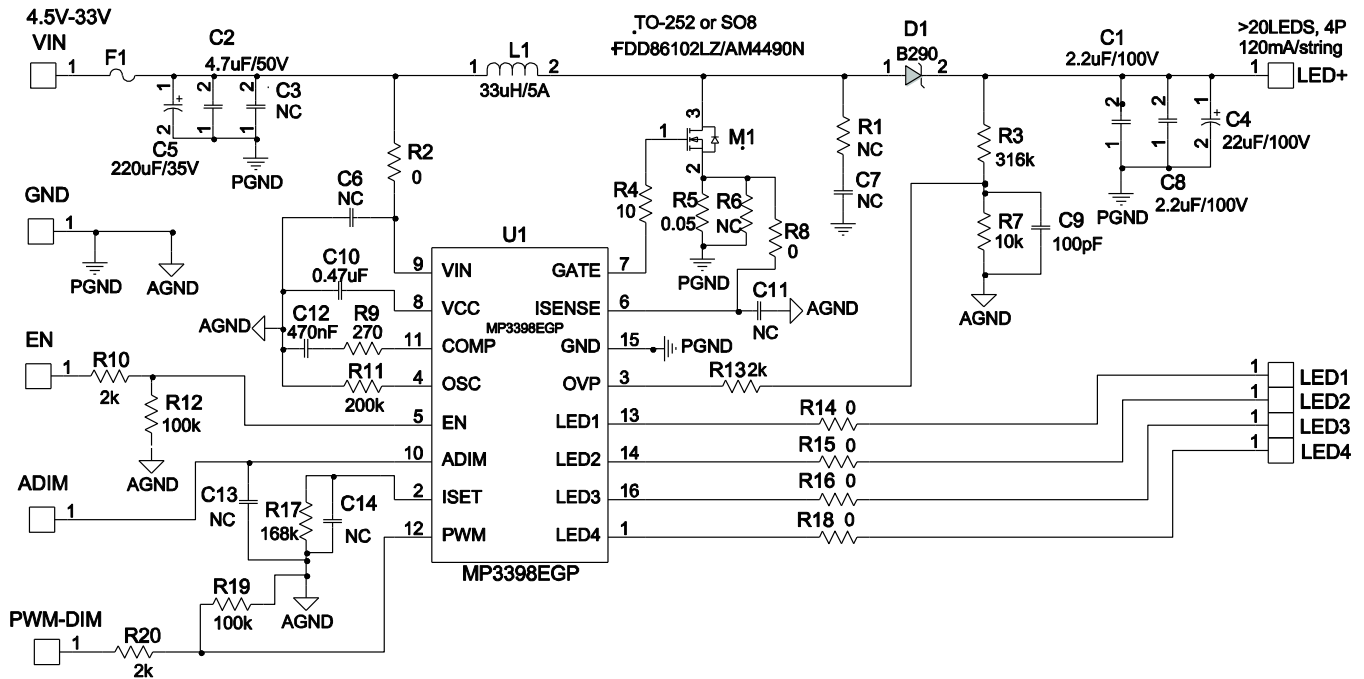

EV3398E-U-00A BILL OF MATERIALS

Qty	Ref	Value	Description	Package	Manufacturer	Part Number
2	C1,C8	2.2 μ F	Ceramic Capacitor, 100V, X7R	1210	Murata	GRM32ER72A225KA35L
1	C2	4.7 μ F	Ceramic Capacitor, 50V, X7R	1210	Murata	GRM32ER71H475KA88L
1	C3	NC		1210		
1	C4	22 μ F	Electrolytic Capacitor, 100V	DIP	JiangHai	CD263-100V22
1	C5	220 μ F	Electrolytic Capacitor, 35V	DIP	JiangHai	CD110-35V220
5	C6,C7, C11,C13, C14	NC		0603		
1	C9	100pF	Ceramic Capacitor, 50V, COG	0603	Murata	GRM1885C1H101JA01D
1	C10	470nF	Ceramic Capacitor, 16V, X7R	0805	Murata	GRM219R71C474KA01D
1	C12	470nF	Ceramic Capacitor, 16V, X7R	0603	Murata	GRM18R7C474KA88D
1	D1		Diode Schottky, 90V, 2A	SMB	Diodes Inc	B290
1	F1	0 Ω	Resistor, 1%	1206	Yageo	RC1206FR-070RL
1	L1	33 μ H	Inductor,5.5A,45mohm	SMD	Würth	7447709330
1	M1		N- channel MOSFET	SO8	Analog Power	AM4490N
1	R1	NC		0603		
6	R2,R8, R14,R15, R16,R18	0 Ω	Resistor, 1%	0603	Yageo	RC0603JR-070RL
1	R3	316k Ω	Resistor, 1%	0603	Yageo	RC0603FR-07316KL
1	R4	10 Ω	Resistor, 1%	0603	Yageo	RC0603FR-0710RL
1	R5	0.05 Ω	Current Resistor, 1%	1206	Yageo	RC1206FR-070R05L
1	R6	NC	Current Resistor, 1%	1206	Yageo	RC1206FR-070R05L
1	R7	10k Ω	Resistor, 1%	0603	Yageo	RC0603FR-0710KL
1	R9	270 Ω	Resistor, 1%	0603	Yageo	RC0603FR-07270RL
3	R10,R13, R20	2k Ω	Resistor, 1%	0603	Yageo	RC0603FR-072KL
1	R11	200k Ω	Resistor, 1%	0603	Yageo	RC0603FR-07100KL
2	R12, R19	100k Ω	Resistor, 1%	0603	Yageo	RC0603FR-07100KL
	U1		LED Driver IC	PDIP-16	MPS	MP3398EGP

EVB TEST RESULTS

Performance waveforms are tested on the evaluation board.

$V_{IN} = 19V$, $V_{EN} = 3.3V$, 120mA/string, 4 strings, 20 LEDs in series, $T_A = 25^\circ C$, unless otherwise noted.

Steady State

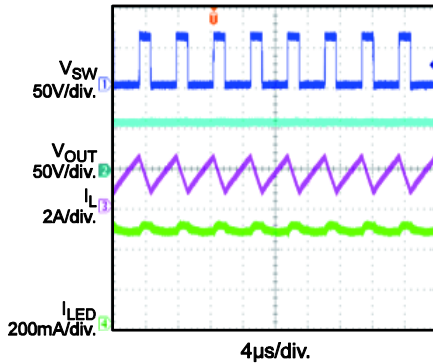

V_{IN} Power On

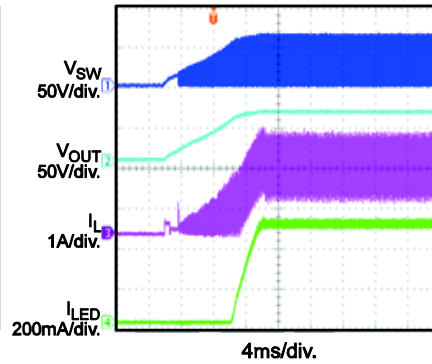

EN On

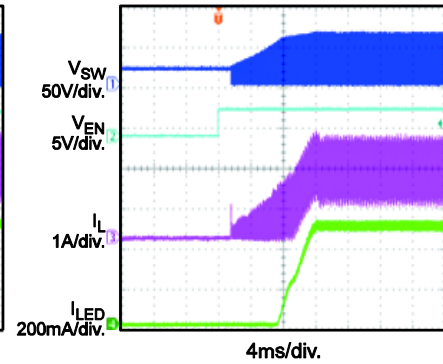

PWM Dimming

$f_{SW} = 200Hz$, $D_{PWM} = 50\%$

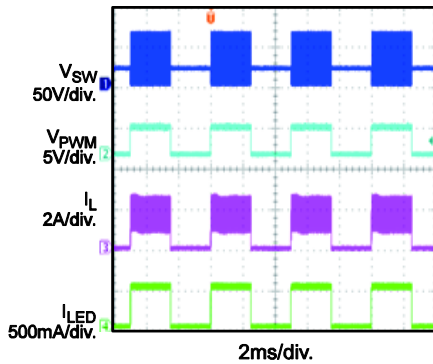

Analog Dimming

$f_{PWM} = 20kHz$, $D_{PWM} = 50\%$

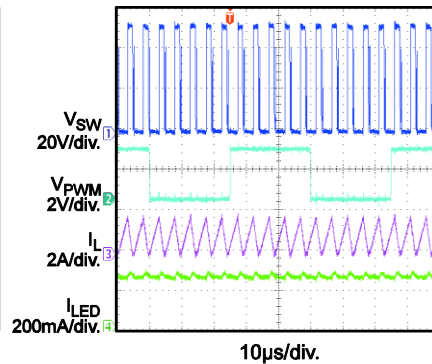

Open LED Protection

Open One LED String at Working

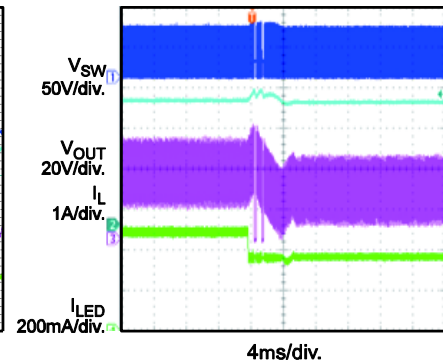

Short LED Protection

Short One LED String at Working

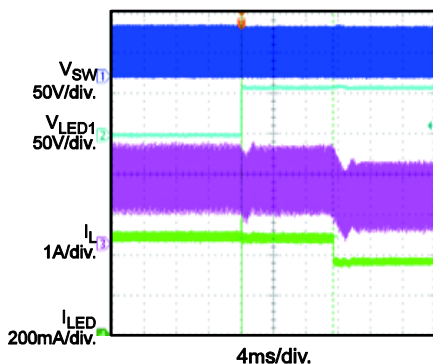

Short-Inductor Protection

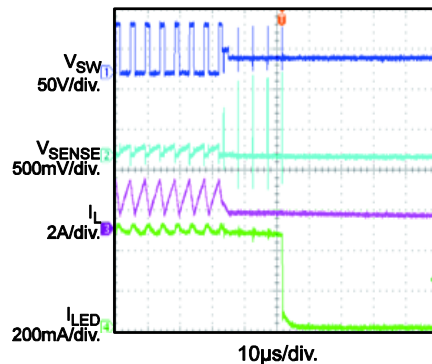

Short-Diode Protection

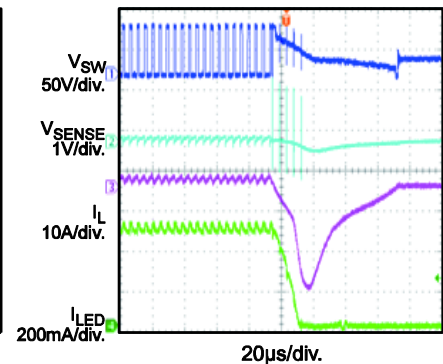

PRINTED CIRCUIT BOARD LAYOUT

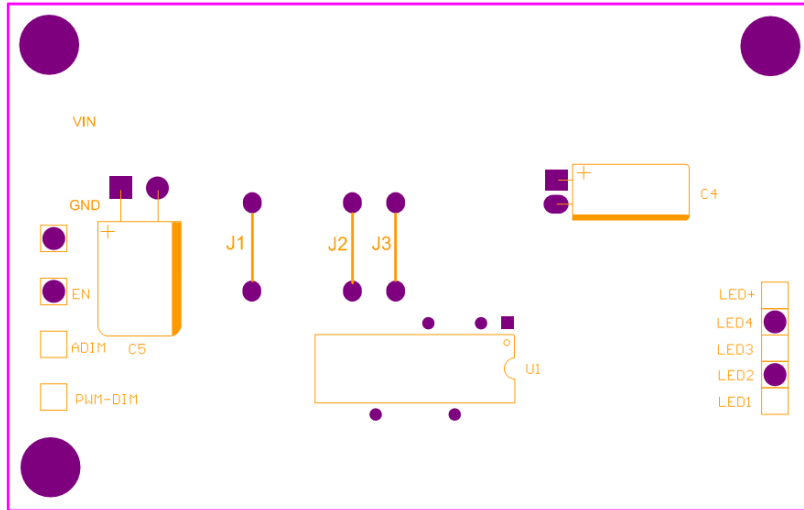

Figure 1—Top Layer

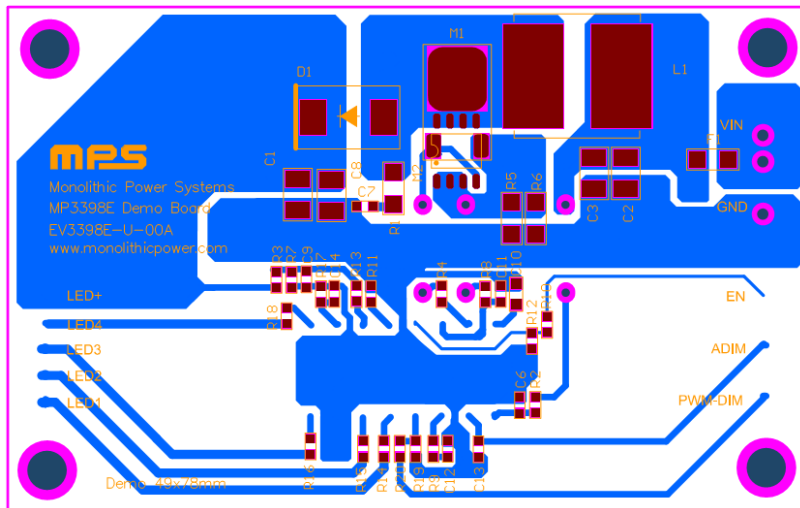

Figure 2—Bottom Layer

QUICK START GUIDE

1. Connect the positive and negative terminals of the load panel (20 white LEDs in series, 4 strings) to the LED+ and LED1~4 pins on the EV board, respectively.
2. Connect the positive and negative terminals of the power supply (13V ~ 33V) to the VIN and GND pins on the EV board, respectively.
3. Drive EN pin high (5V) to enable the MP3398E.
4. For PWM dimming, apply a PWM rectangular waveform with a minimum voltage less than 0.4V and a maximum greater than 1.5V on PDIM pin. The frequency of the PWM signal is recommended between 200Hz to 2kHz.
5. For analog dimming, apply a PWM rectangular waveform with a minimum voltage less than 0.4V and a maximum greater than 1.5V on ADIM pin. The frequency of the PWM signal is recommended between >20kHz.

NOTICE: The information in this document is subject to change without notice. Users should warrant and guarantee that third party Intellectual Property rights are not infringed upon when integrating MPS products into any application. MPS will not assume any legal responsibility for any said applications.