

DESCRIPTION

The MP3426 is a current-mode step-up converter with a 6A, 90mΩ internal switch that provides a highly efficient regulator with a fast response. The MP3426 features a programmable frequency of up to 2MHz that allows for easy filtering and reduces noise. An external compensation pin gives the user flexibility in setting loop dynamics, and uses small, low-ESR, ceramic output capacitors. Soft-start results in a small inrush current and can be programmed with an external capacitor. The MP3426 operates from an input voltage as low as 3.2V and can generate up to a 35V output.

The MP3426's features include under-voltage lockout, current limiting, and thermal overload protection. The MP3426 is available in a low profile 14-pin 3mm×4mm QFN package with an exposed pad.

FEATURES

- 6A, 90mΩ, 45V Power MOSFET
- Uses Very Small Capacitors and Inductors
- Wide Input Range: 3.2V to 22V
- Output Voltage as High as 35V
- Programmable f_{sw} : 300kHz to 2MHz
- Programmable UVLO, Soft-Start, UVLO Hysteresis
- Micropower Shutdown <1μA
- Thermal Shutdown 160°C
- Available in 14-Pin 3mm×4mm QFN Package

APPLICATIONS

- Telecom—Power Supplies
- Audio—Microphone and Tuner Bias
- Automotive

All MPS parts are lead-free and adhere to the RoHS directive. For MPS green status, please visit MPS website under Quality Assurance. MPS[®] and "The Future of Analog IC Technology" are Registered Trademarks of Monolithic Power Systems, Inc.

ELECTRICAL SPECIFICATIONS

Parameter	Symbol	Value	Units
Input Voltage	V_{IN}	6-9	V
Output Voltage	V_{OUT}	12	V
Output Current	I_{OUT}	2	A

EV3426-L-00A EVALUATION BOARD



(L x W x H) 2.5" x 2.5" x 0.4"
(6.35cm x 6.35cm x 1.0cm)

Board Number	IC Number
EV3426-L-00A	MP3426DL

Efficiency

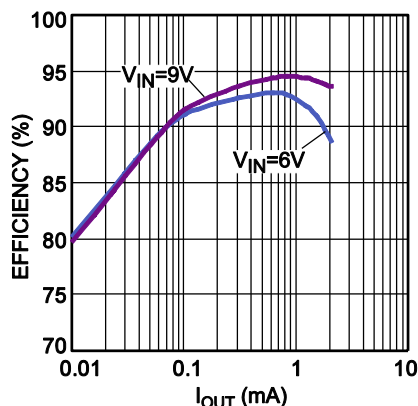

EVALUATION BOARD SCHEMATIC

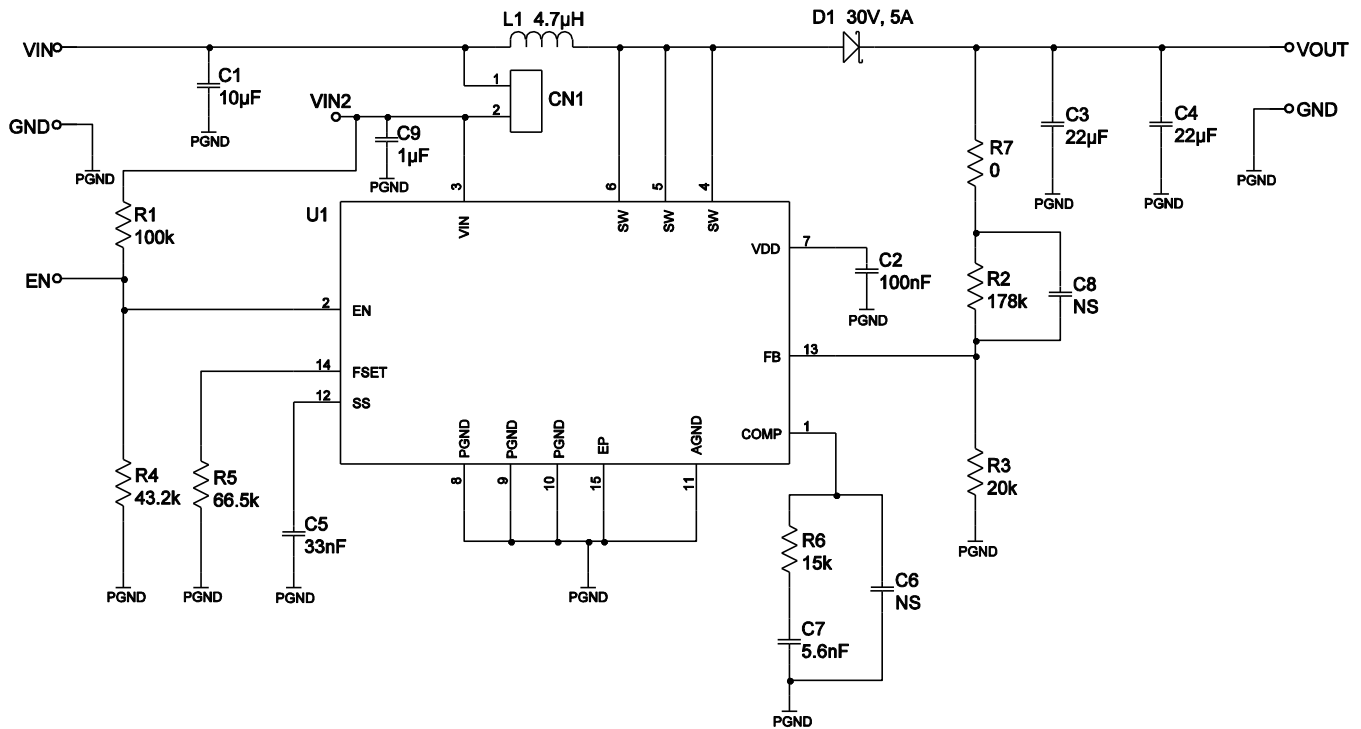

EV3426-L-00A BILL OF MATERIALS

Qty	Ref	Value	Description	Package	Manufacturer	Manufacturer P/N
1	R1	100k	Film Res,5%	0603	ROYAL	RL0603FR-07100KL
1	R2	178k	Film Res,1%	0603	ROYAL	RL0603FR-07178KL
1	R3	20k	Film Res,1%	0603	ROYAL	RL0603FR-0720KL
1	R4	43.2k	Film Res,5%	0603	ROYAL	RC0603FR-0743K2L
1	R5	66.5k	Film Res,1%	0603	ROYAL	RC0603FR-0766K5L
1	R6	15k	Film Res,5%	0603	ROYAL	RL0603FR-0715KL
1	R7	0	Film Res,5%	0603	ROYAL	RC0603FR-070RL
1	C1	10µF	Ceramic Cap,25V,X7R	1210	muRata	GRM32DR71E106KA12L
1	C2	0.1µF	Ceramic Cap,16V,X7R	0805	muRata	GRM219R71C104KA01D
2	C3,C4	22µF	Ceramic Cap,25V,X7R	1210	muRata	GRM32ER71E226KE15L
1	C5	33nF	Ceramic Cap,50V,X7R	0603	TDK	C1608X7R1H333K
1	C6,C8	NC				
1	C7	5.6nF	Ceramic Cap,50V,X7R	0603	muRata	GRM188R71H562KA01D
1	C9	1.0µF	Ceramic Cap,25V,X5R	0805	muRata	GRM216R61E105KA12D
1	L1	4.7µH	IR=15.5A, Isat=17A, Rdc=6.35mOhm		Wurth	744 332 047 0
1	D1	SS5P3	Schottky diode 30V 5A	TO-277A	Vishay	SS5P3
1	U1	MP3426	Boost converter	QFN	MPS	MP3426

EVB TEST RESULTS

Performance waveforms are tested on the evaluation board.

Efficiency

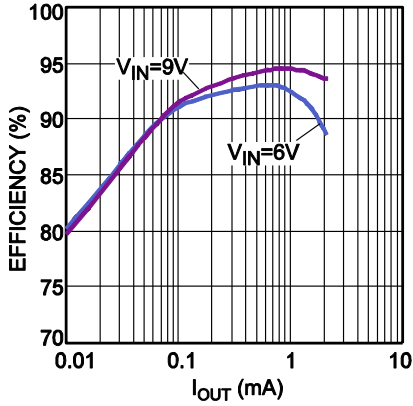

Line Regulation

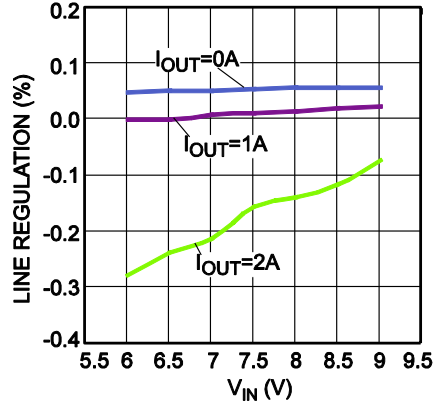

Load Regulation

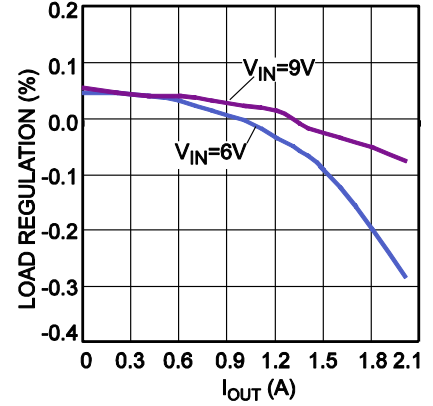

Case Temperature Rising vs. Load Current

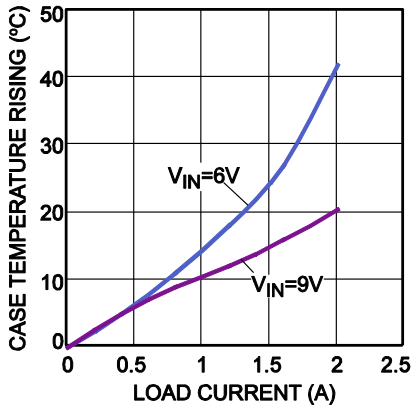

EVB TEST RESULTS (continued)

Performance waveforms are tested on the evaluation board.

Steady State

$V_{IN} = 6V, V_{OUT} = 12V/0A$

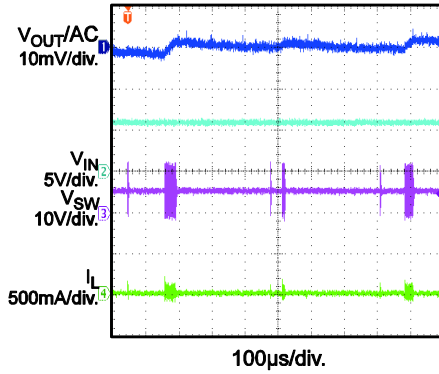

Steady State

$V_{IN} = 6V, V_{OUT} = 12V/2A$

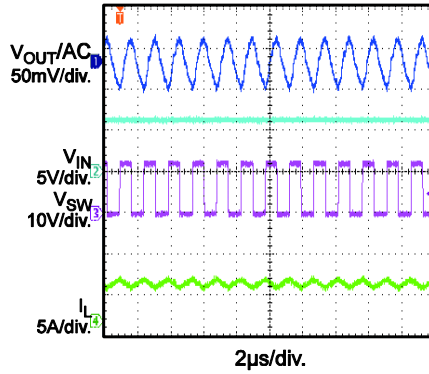

VIN Start Up

$V_{IN} = 6V, V_{OUT} = 12V/0A$

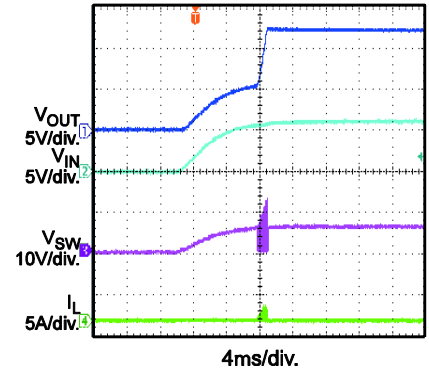

VIN Start Up

$V_{IN} = 6V, V_{OUT} = 12V/2A$

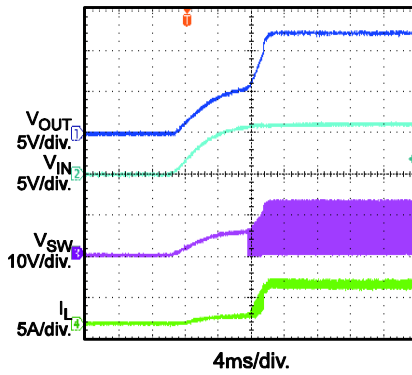

VIN Shutdown

$V_{IN} = 6V, V_{OUT} = 12V/0A$

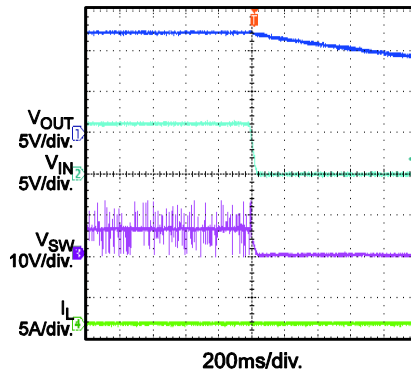

VIN Shutdown

$V_{IN} = 6V, V_{OUT} = 12V/2A$

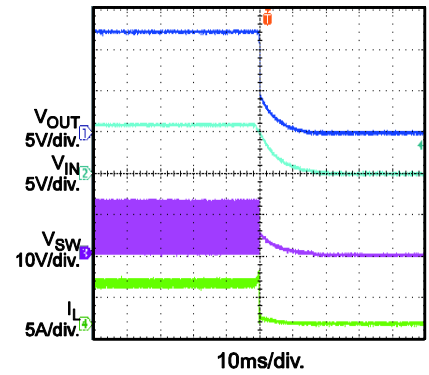

EN Startup

$V_{IN} = 6V, V_{OUT} = 12V/0A$

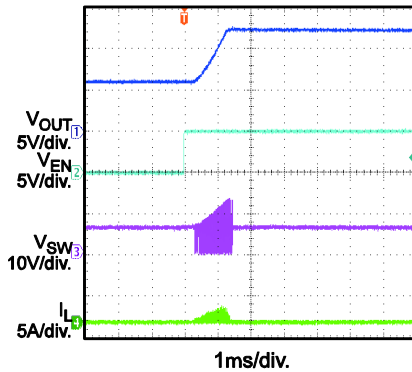

EN Startup

$V_{IN} = 6V, V_{OUT} = 12V/2A$

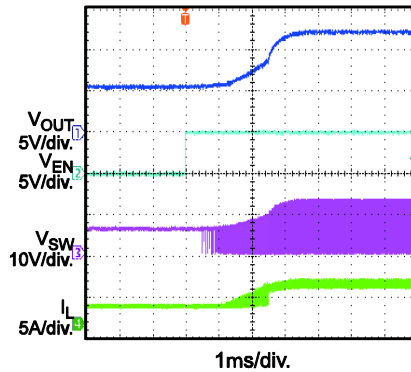

EN Shutdown

$V_{IN} = 6V, V_{OUT} = 12V/0A$

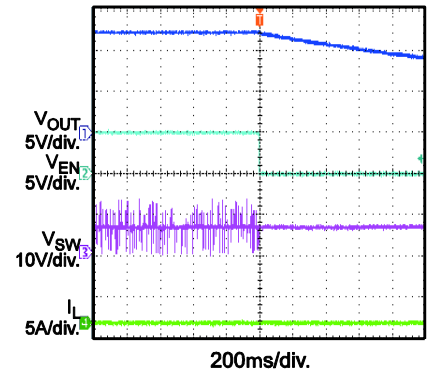

EVB TEST RESULTS *(continued)*

Performance waveforms are tested on the evaluation board.

EN Shutdown

$V_{IN} = 6V$, $V_{OUT} = 12V/2A$

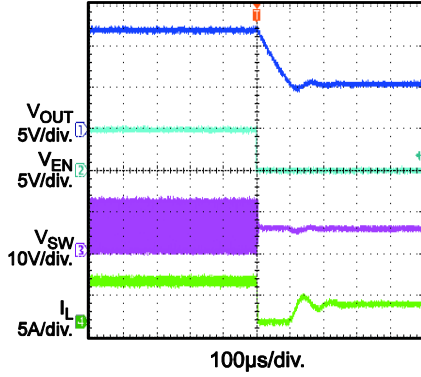

Load Transient

$V_{IN} = 6V$, $V_{OUT} = 12V$,
 $I_{OUT} = 0$ to 1A, $I_{RAMP} = 10mA/\mu s$

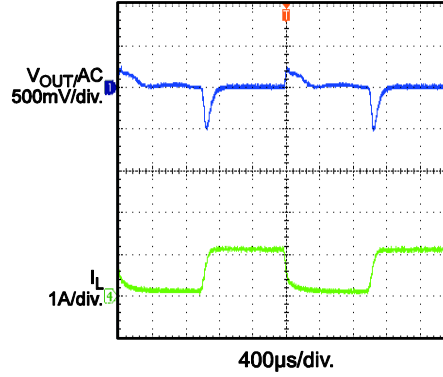

Load Transient

$V_{IN} = 6V$, $V_{OUT} = 12V$,
 $I_{OUT} = 1$ to 2A, $I_{RAMP} = 10mA/\mu s$

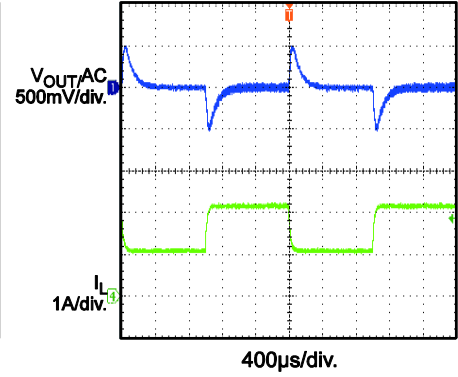

QUICK START GUIDE

The output voltage of this board is set to 12V. The frequency is set to 600kHz. The board layout accommodates most commonly used inductors and output capacitors.

1. Preset the power supply to $6V \leq V_{IN} \leq 9V$.
2. Turn the power supply off.
3. Connect the power supply terminals to:
 - a. Positive (+): VIN
 - b. Negative (-): GND
4. Connect the load to:
 - a. Positive (+): VOUT
 - b. Negative (-): GND
5. Make sure the CN1 jumper is installed
6. Turn the power supply on after making the connections.
7. The MP3426 is enabled on the evaluation board once VIN is applied.
8. The output voltage VOUT can be changed by varying R2. Calculate the new value using the formula: $R2 = \left(\frac{V_{OUT}}{V_{FB}} - 1\right) \times R3$
Where $V_{FB} = 1.225V$ and $R3=20k\Omega$
9. The frequency can be changed by adjusting R5. The formula is: $F_{SET} = 23 \times (R5^{-0.86})$
Where FSET is in MHz and R5 is in k Ω

NOTICE: The information in this document is subject to change without notice. Users should warrant and guarantee that third party Intellectual Property rights are not infringed upon when integrating MPS products into any application. MPS will not assume any legal responsibility for any said applications.