



The Future of Analog IC Technology®

# EV3429-L-00A

## 21A High Efficiency Fully-Integrated Synchronous Boost Converter EV Board

### DESCRIPTION

EV3429-L-00A Evaluation Board is designed to demonstrate the capability of MP3429. The MP3429 is a 600kHz fixed frequency, wide input range, highly integrated boost converter. It starts from an input voltage as low as 2.7V, and supports up to 30W load power from 1-cell battery.

MP3429 adopts constant-off-time (COT) control topology providing fast transient response. One MODE pin supports mode selection of PSM, FCCM and USM in light load condition. And the integrated LS and HS MOSFET simplify the design and save BOM cost.

The MP3429 also features with programmable input UVLO and over temperature protection.

The MP3429 is available in a 13-pin 3mmx4mm QFN package.

### Electrical Specification

| Parameter      | Symbol    | Value              | Units |
|----------------|-----------|--------------------|-------|
| Input Voltage  | $V_{IN}$  | 2.7-8.4            | V     |
| Output Voltage | $V_{OUT}$ | 9                  | V     |
| Output Current | $I_{OUT}$ | 3.5 <sup>(1)</sup> | A     |

**Note:**

1) When  $V_{IN}=2.7V$ ,  $I_{OUT}=3.5A$ , the case temperature should be high, It is limited by PCB size. Please decrease the load based the permitted temperature performance.

### FEATURES

- 2.7V-to-13V Startup Voltage
- 0.8V-to-13V Operation Voltage
- Up to 16V Output Voltage
- Support 30W Average Power Load and 40W Peak Power Load from 3.3V
- 21.5A Internal Switch Current Limit
- Integrated 6.5mΩ & 10mΩ Power MOSFET
- >95% Efficiency for 3.6V  $V_{IN}$  to 9V/3A
- Selectable PSM, >23kHz USM, and FCCM Mode in Light Load Condition
- 600kHz Fixed Switching Frequency
- Adaptive COT for Fast Transient Response
- External Soft Start and Compensation Pin
- Programmable UVLO and Hysteresis
- 150°C Over Temperature Protection
- Available in 3x4mm QFN-13 Package

### APPLICATIONS

- Notebook
- Bluetooth Speaker
- Portable POS System
- Quick Charger Power Bank

All MPS parts are lead-free and adhere to the RoHS directive. For MPS green status, please visit MPS website under Products, Quality Assurance page.

"MPS" and "The Future of Analog IC Technology" are Registered Trademarks of Monolithic Power Systems, Inc.

## EV3429-L-00A EVALUATION BOARD



(L x W x H) 6.35cm x 6.35cm x 0.6cm

| Board Number | MPS IC Number |
|--------------|---------------|
| EV3429-L-00A | MP3429GL      |

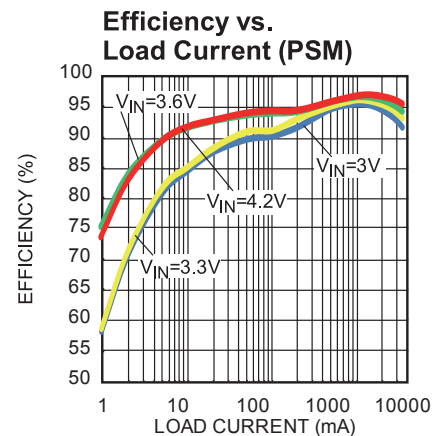

## EVALUATION BOARD SCHEMATIC

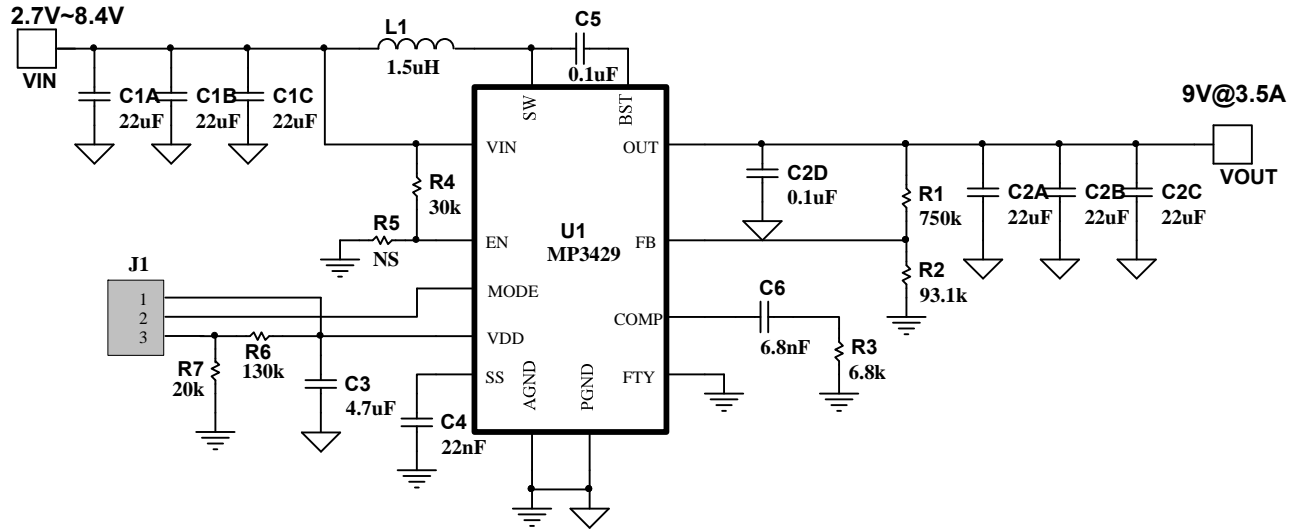

## EV3429-L-00A BILL OF MATERIALS

| Qty | Ref                          | Value  | Description                      | Package   | Manufacturer | Part Number         |
|-----|------------------------------|--------|----------------------------------|-----------|--------------|---------------------|
| 6   | C1A, C1B, C1C, C2A, C2B, C2C | 22µF   | Ceramic Cap,25V,X5R              | 1210      | MuRata       | GRM32ER61E226KE15L  |
| 2   | C2D, C5                      | 0.1µF  | Ceramic Cap,25V,X7R              | 0603      | MuRata       | GRM188R71E104KA01D  |
| 1   | C3                           | 4.7µF  | Ceramic Cap,6.3V,X5R             | 0603      | MuRata       | GRM188R71J475KA01D  |
| 1   | C4                           | 22nF   | Ceramic Cap,16V,X7R              | 0603      | MuRata       | GRM188R71C223KA01D  |
| 1   | C6                           | 6.8nF  | Ceramic Cap,50V,X7R              | 0603      | MuRata       | GRM188R71H682KA01D  |
| 1   | R1                           | 750K   | Film Res,1%                      | 0603      | ROYAL        | RL0603FR-07750KL    |
| 1   | R2                           | 93.1K  | Film Res,1%                      | 0603      | ROYAL        | RL0603FR-0793K1L    |
| 1   | R3                           | 6.8K   | Film Res,1%                      | 0603      | ROYAL        | RL0603FR-076K8L     |
| 1   | R4                           | 30K    | Film Res,1%                      | 0603      | ROYAL        | RL0603FR-0730KL     |
| 0   | R5                           | NC     |                                  |           |              |                     |
| 1   | R6                           | 130K   | Film Res,1%                      | 0603      | ROYAL        | RL0603FR-07130KL    |
| 1   | R7                           | 20K    | Film Res,1%                      | 0603      | ROYAL        | RL0603FR-0720KL     |
| 1   | L1                           | 1.5µH  | $I_{RMS}=19A, R_{DC}=3.3m\Omega$ | 11.5x10mm | Sumida       | 104CDMCCDS-1R5MC-ND |
| 1   | J1                           | Jumper | Short Jumper, 2.54mm             |           |              | Jumper              |
| 1   | U1                           | MP3429 | Boost converter                  | QFN 3X4mm | MPS          | MP3429GL            |

## EVB TEST RESULTS

$V_{IN} = 3.3V$ ,  $V_{OUT} = 9V$ ,  $L = 1.5\mu H$ ,  $I_{OUT} = 3.5A$ , PSM,  $T_A = 25^\circ C$ , unless otherwise noted.

**Efficiency vs. Load Current (PSM)**

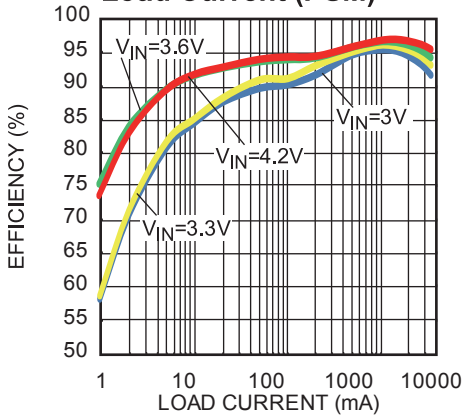

**Load Regulation (PSM)**

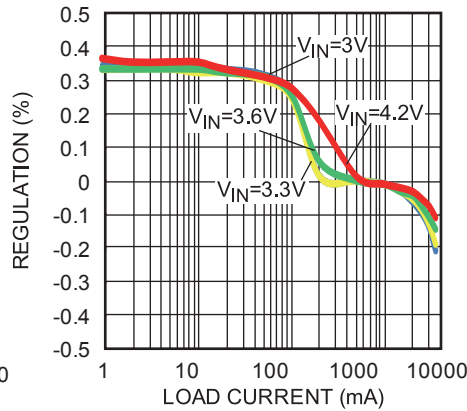

**Line Regulation (PSM)**

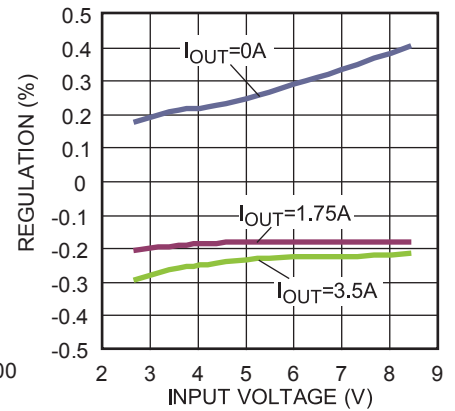

**Bode Plot**

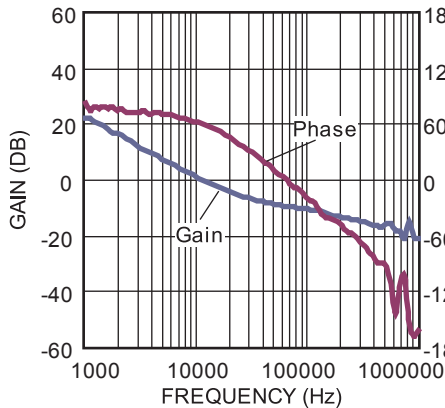

**Case Temperature Rising**

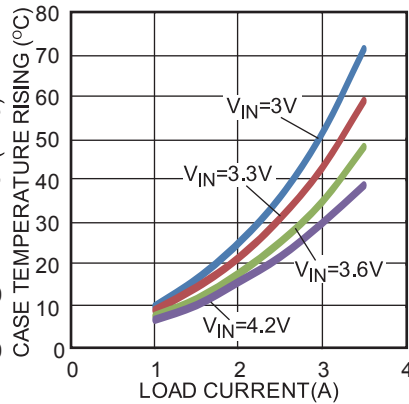

## EVB TEST RESULTS (continued)

$V_{IN} = 3.3V$ ,  $V_{OUT} = 9V$ ,  $L = 1.5\mu H$ ,  $I_{OUT} = 3.5A$ , PSM,  $T_A = 25^\circ C$ , unless otherwise noted.

**Steady State**  
 $I_{OUT} = 0A$ , USM

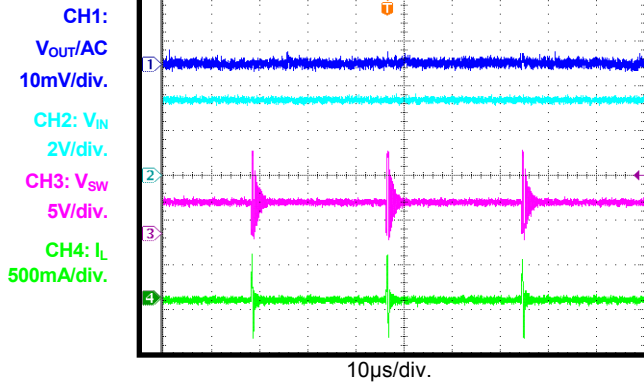

**Steady State**  
 $I_{OUT} = 0A$ , PSM

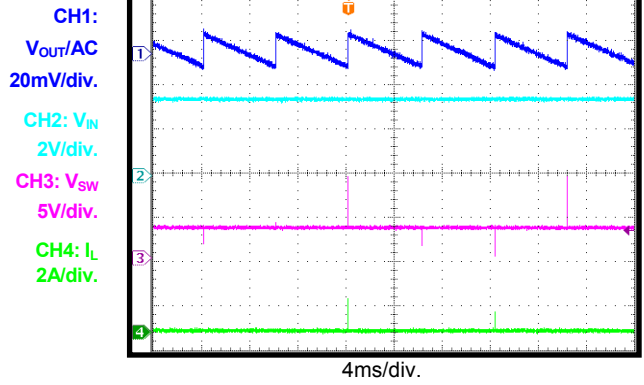

**Steady State**  
 $I_{OUT} = 0A$ , FCCM

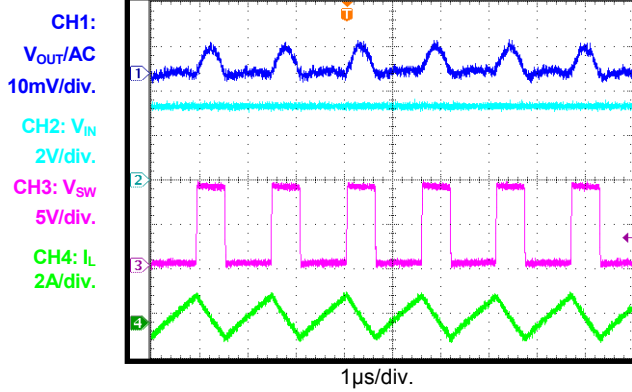

**Steady State**  
 $I_{OUT} = 3.5A$

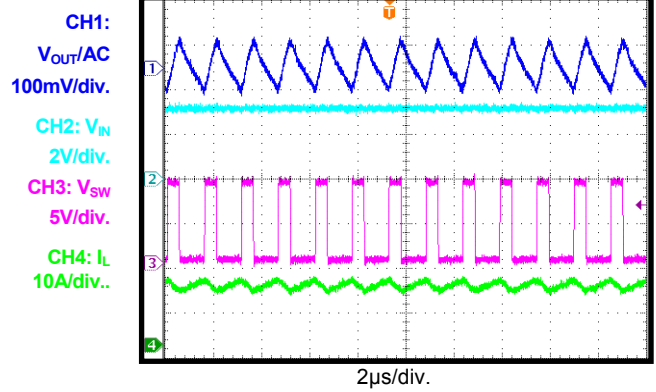

**$V_{IN}$  Start-Up**  
 $I_{OUT} = 0A$

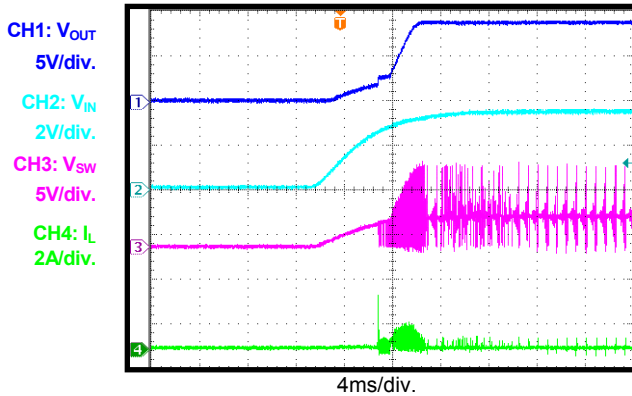

**$V_{IN}$  Start-Up**  
 $I_{OUT} = 3.5A$

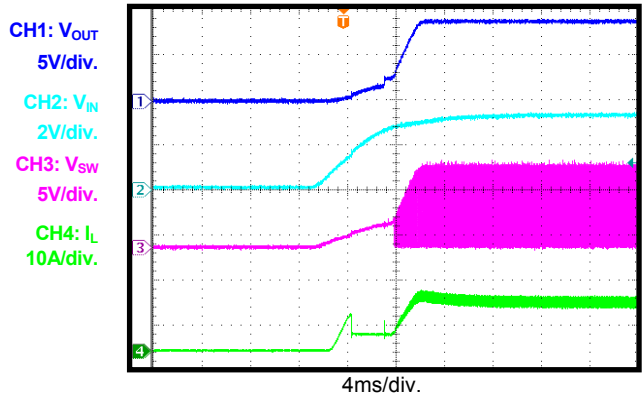

## EVB TEST RESULTS (continued)

$V_{IN} = 3.3V$ ,  $V_{OUT} = 9V$ ,  $L = 1.5\mu H$ ,  $I_{OUT} = 3.5A$ , PSM,  $T_A = 25^\circ C$ , unless otherwise noted.

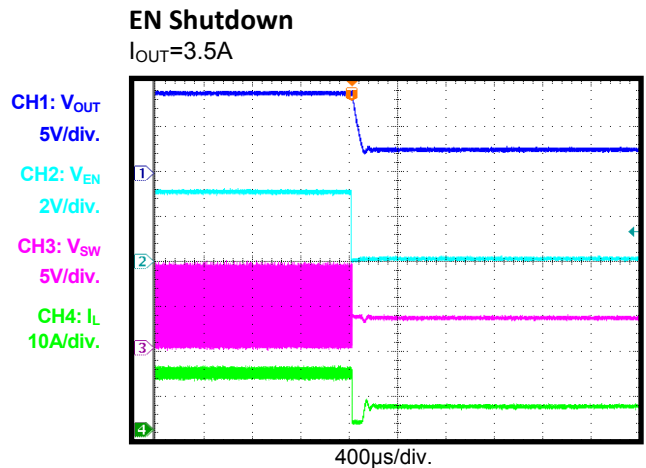
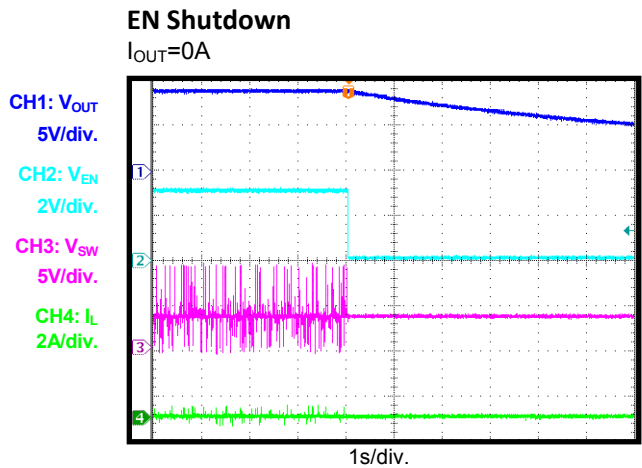
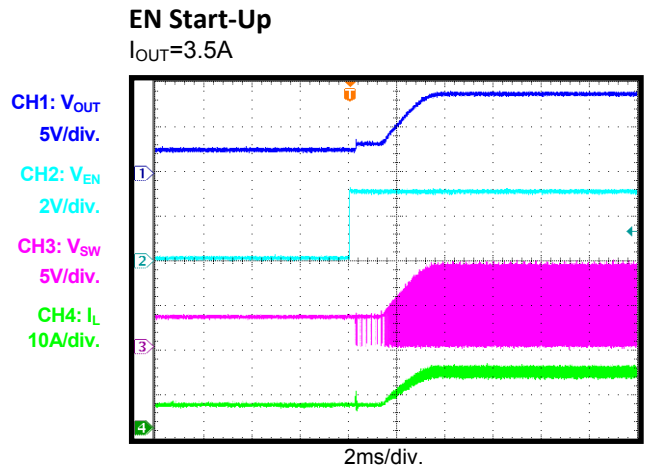
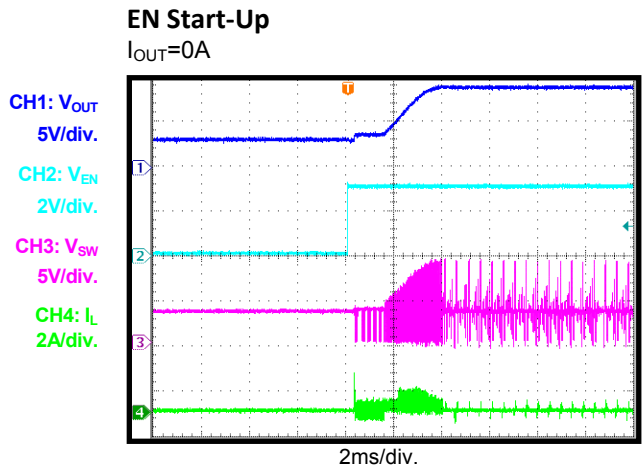
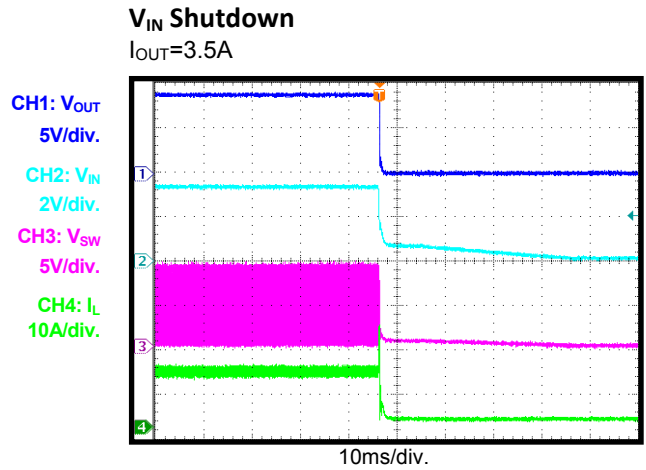
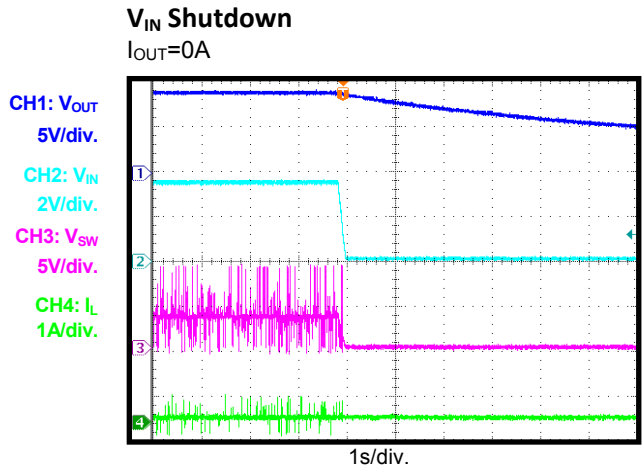

## EVB TEST RESULTS (continued)

$V_{IN} = 3.3V$ ,  $V_{OUT} = 9V$ ,  $L = 1.5\mu H$ ,  $I_{OUT} = 3.5A$ , PSM,  $T_A = 25^\circ C$ , unless otherwise noted.

**Load Transient**

$I_{OUT} = 0A - 1.75A$ ,  $I_{RAMP} = 25mA/\mu s$ , USM

CH1:  
 $V_{OUT}/AC$   
500mV/div.  
CH4:  $I_{OUT}$   
2A/div.

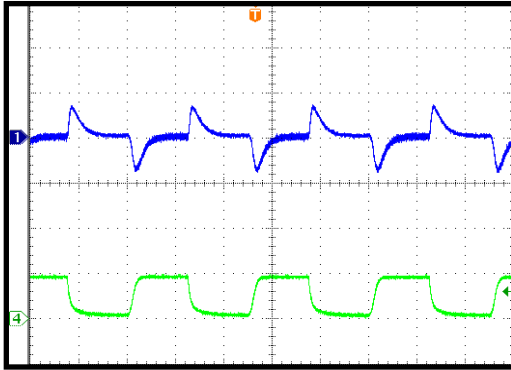

400µs/div.

**Load Transient**

$I_{OUT} = 3.5A - 1.75A$ ,  $I_{RAMP} = 25mA/\mu s$

CH1:  
 $V_{OUT}/AC$   
500mV/div.  
CH4:  $I_{OUT}$   
2A/div.

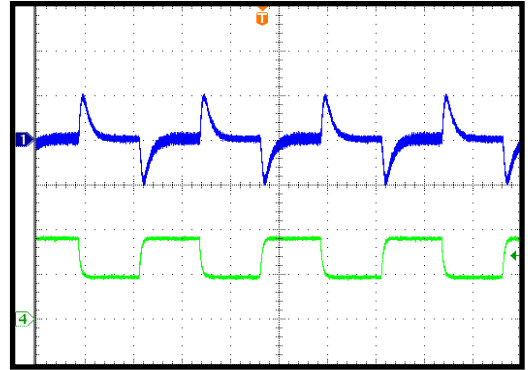

400µs/div.

**Load Transient**

$I_{OUT} = 0A - 1.75A$ ,  $I_{RAMP} = 25mA/\mu s$ , PSM

CH1:  
 $V_{OUT}/AC$   
500mV/div.  
CH4:  $I_{LOAD}$   
2A/div.

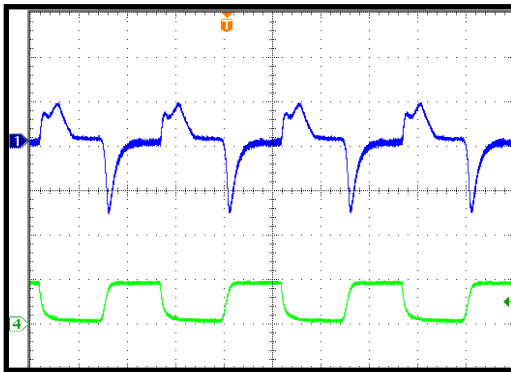

400µs/div.

**Load Transient**

$I_{OUT} = 0A - 1.75A$ ,  $I_{RAMP} = 25mA/\mu s$ , FCCM

CH1:  
 $V_{OUT}/AC$   
500mV/div.  
CH4:  $I_{LOAD}$   
2A/div.

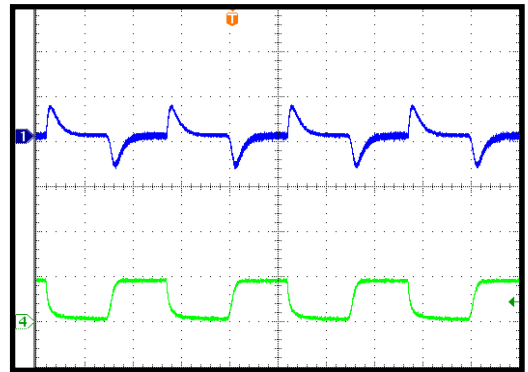

400µs/div.

## PRINTED CIRCUIT BOARD LAYOUT

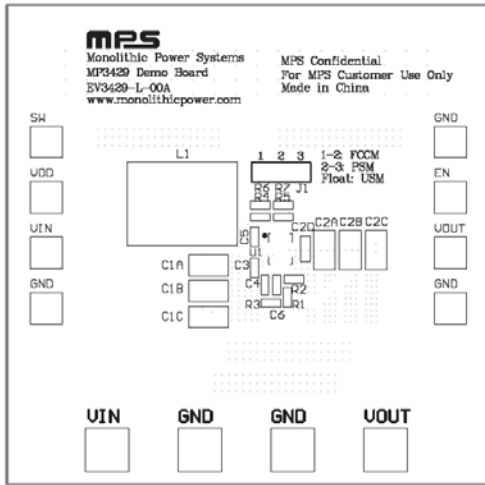

Figure 1—Top Silk Layer

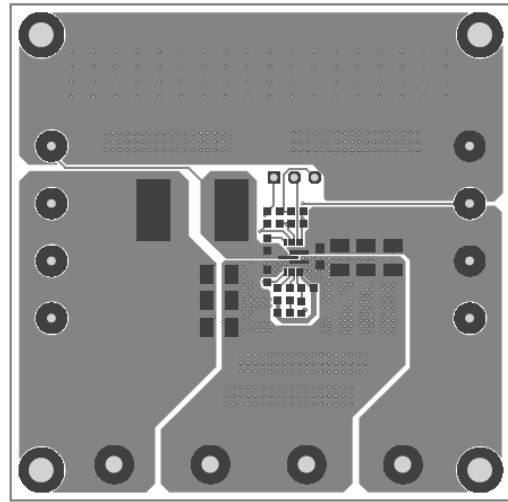

Figure 2—Top Layer

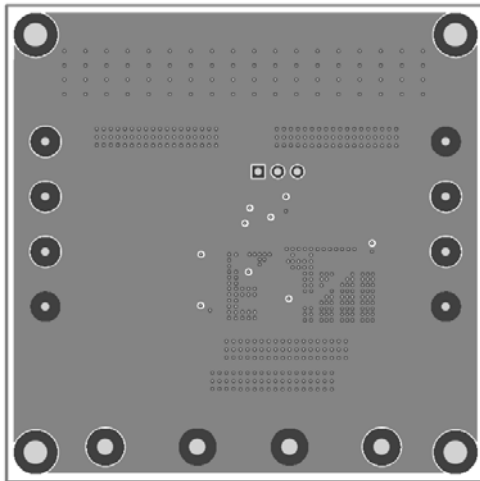

Figure 3—Inner Layer 1

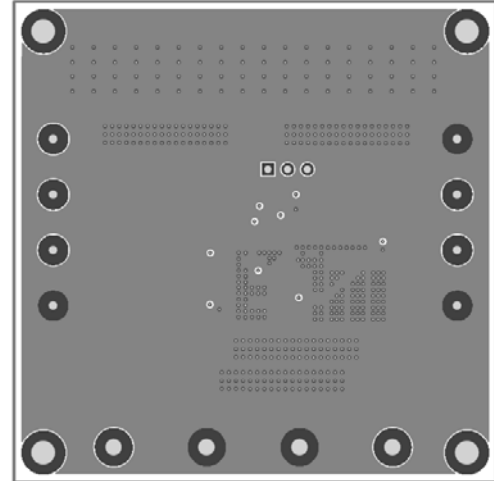

Figure 4—Inner Layer 2

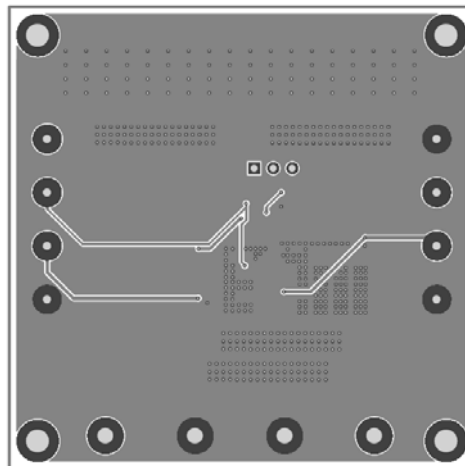

Figure 5—Bottom Layer

## QUICK START GUIDE

The output voltage of this board is set to 9V. The board layout accommodates most commonly used components. Following are steps to quick start EV3429-L-00A.

1. Preset Power Supply to  $2.7V \leq V_{IN} \leq 8.4V$ .
2. Turn Power Supply off.
3. Connect Power Supply terminals to:
  - a. Positive (+): VIN
  - b. Negative (-): GND
4. Connect Load to:
  - a. Positive (+): VOUT
  - b. Negative (-): GND
5. Turn Power Supply on after making connections.
6. The MP3429 is enabled on the evaluation board once VIN is applied.
7. The output voltage VOUT can be changed by varying R2. Calculate the new value using the formula:

$$V_{OUT} = V_{FB} \times \left(1 + \frac{R1}{R2}\right)$$

Where  $V_{FB} = 1V$  and  $R1 = 750k\Omega$ .

8. If USM and FCCM is needed, following below steps:
  - a. Turn Power Supply off.
  - b. Change J1 connection. Connect 1 to 2 for FCCM, connect 2 to 3 for PSM, and float 2 for USM.
  - c. Turn the power on. IC will work with the mode which is set by step b.

**NOTICE:** The information in this document is subject to change without notice. Please contact MPS for current specifications. Users should warrant and guarantee that third party Intellectual Property rights are not infringed upon when integrating MPS products into any application. MPS will not assume any legal responsibility for any said applications.