

DESCRIPTION

EV3910-K-00A Evaluation Board is designed to demonstrate the capabilities of MP3910. MP3910 is a Peak Current Mode PWM controller that can drive an external MOSFET capable of handling >10A current. It can accommodate flyback, boost for isolated and non-isolated applications.

While designed for Flyback applications, the 1A gate driver minimizes the power loss of the external MOSFET while allowing the use of a wide variety of standard threshold devices. Additionally, MP3910 has pulse skipping Mode function that improves the efficiency with light load or no load. It also provides hiccup protection for OLP, OVP and SCP condition.

The MP3910 is available in MSOP10 package.

ELECTRICAL SPECIFICATIONS

Parameter	Symbol	Value	Units
Input voltage	V_{IN}	36-72	V
Output voltage	V_{OUT}	12	V
Output current	I_{OUT}	2.5	A
Frequency	F_S	250	kHz

FEATURES

- Wide 36V to 72V V_{IN} Range
- 1A 12V MOSFET Gate Driver
- External Soft-Start
- Pulse Skipping Operation with Light Load
- Programmable Switching Frequency (30kHz-to-400kHz)
- Synchronizable from 80kHz-to-400kHz
- Cycle-by-Cycle Current Limit
- Over Load Protection
- Over Voltage Protection
- Short Circuit Protection
- Available in an MSOP10 Package

APPLICATIONS

- Telecom Isolated Power
- Brick Modules
- Off-line Controller
- General Step Up Applications

All MPS parts are lead-free and adhere to the RoHS directive. For MPS green status, please visit MPS website under Products, Quality Assurance page. "MPS" and "The Future of Analog IC Technology" are Registered Trademarks of Monolithic Power Systems, Inc.

EV3910-K-00A EVALUATION BOARD



(L x W x H) 3.3" x 1.5" x 0.6"
(8.5cm x 3.8cm x 1.5cm)

Board Number	MPS IC Number
EV3910-K-00A	MP3910GK

Efficiency vs. Load Current

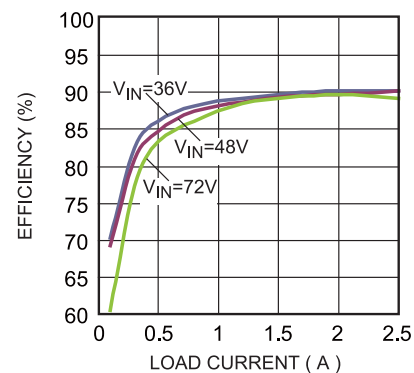

EVALUATION BOARD SCHEMATIC

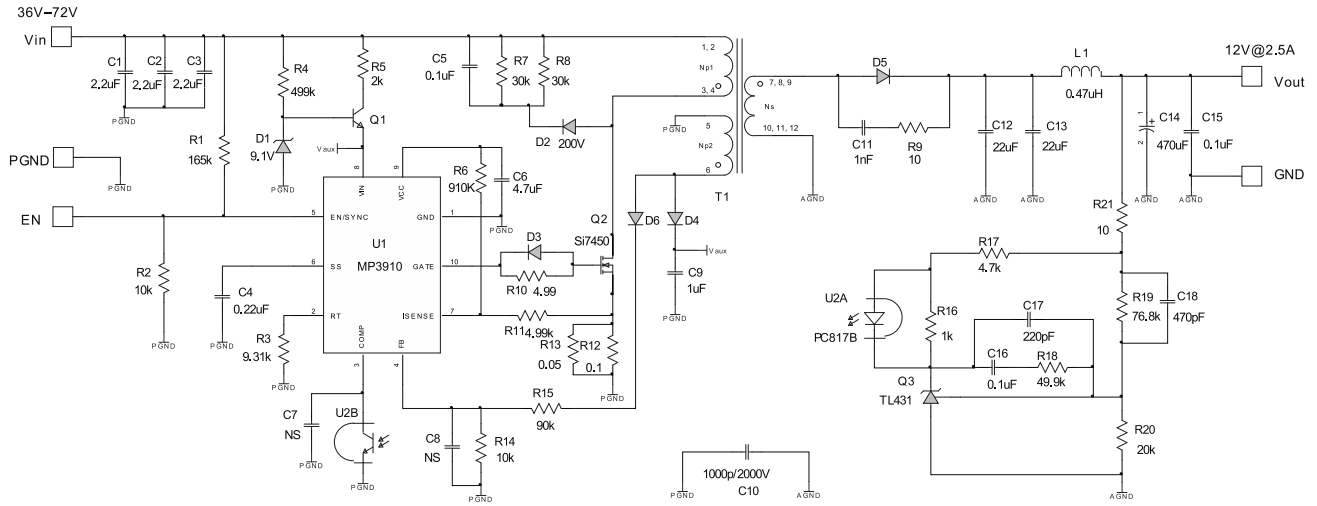

EV3910-K-00A BILL OF MATERIALS

Qty	Ref	Value	Description	Package	Manufacturer	Part Number
3	C1,C2, C3	2.2uF	Ceramic Cap. 100V X7R	1210	muRata	GRM32ER72A225KA352
1	C4	0.22uF	Ceramic Cap. 50V X7R	0603	muRata	GRM188R71H224KA93D
1	C5	0.1uF	Ceramic Cap. 100V X7R	0805	muRata	GRM21BR72A104KAC4 L
1	C6	4.7uF	Ceramic Cap. 16V X7R	0805	muRata	GRM21BR71C475KA73L
2	C7,C8	NS				
1	C9	1uF	Ceramic Cap. 16V X7R	0805	muRata	GRM188R71C105KA12D
1	C10	1nF	Ceramic Cap. 2000V X7R	1808	muRata	GR442QR73D102KW01L
1	C11	1nF	Ceramic Cap. 50V X7R	0603	muRata	GRM188R71H102KA01D
2	C12,C13	22uF	Ceramic Cap. 25V X5R	1210	muRata	GRM32ER61E226ME15
1	C14	470uF	25V Electrolytic	DIP	Rubycon	470uF/25V
2	C15,C16	0.1uF	Ceramic Cap. 50V X7R	0603	muRata	GRM188R71H104KA93D
1	C17	220pF	Ceramic Cap. 50V X7R	0603	muRata	GRM188R71H221KA01D
1	C18	470pF	Ceramic Cap. 50V X7R	0603	muRata	GRM188R71H471KA01D
1	R1	165k	Film Resistor 1%	0603	Yageo	RC0603FR-07165KL
2	R2,R14	10k	Film Resistor 1%	0603	Yageo	RC0603FR-0710KL
1	R3	9.31k	Film Resistor 1%	0603	Yageo	RC0603FR-079K31L
1	R4	499k	Film Resistor 5%	0603	Yageo	RC0603JR-07499KL
1	R5	2k	Film Resistor 5%	0603	Yageo	RC0603JR-072KL
1	R6	910k	Film Resistor 5%	0603	Yageo	RC0603JR-07910KL
2	R7,R8	30k	Film Resistor 5%	0805	Yageo	RC0805JR-0730KL
2	R9,R21	10R	Film Resistor 5%	0603	Yageo	RC0603JR-0710RL
1	R10	4.99R	Film Resistor 5%	0603	Yageo	RC0603JR-074R99L
1	R11	4.99k	Film Resistor 5%	0603	Yageo	RC0603JR-074K99L
1	R12	50mΩ	Strip Resistor 1%	1206	CYNTEC	RL1632H-R050-FN
1	R13	100mΩ	Strip Resistor 1%	1206	CYNTEC	RL1632H-R100-FN
1	R15	90k	Film Resistor 1%	0603	Yageo	RC0603FR-0790KL
1	R16	1k	Film Resistor 1%	0603	Yageo	RC0603FR-071KL
1	R17	4.7k	Film Resistor 5%	0603	Yageo	RC0603JR-074K7L
1	R18	49.9k	Film Resistor 5%	0603	Yageo	RC0603JR-0749K9L
1	R19	76.8k	Film Resistor 1%	0603	Yageo	RC0603FR-0776K8L
1	R20	20k	Film Resistor 1%	0603	Yageo	RC0603FR-0720KL
1	D1	9.1V	Diode Zener 9.1V	SOD-123	Diodes Inc	BZT52C9V1
1	D2	BAV21	Switching Diode 200V 200mW	SOD-123	Diodes Inc	BAV21W-7-F
3	D3,D4,D6	1N4148	Switching Diode 75V 250mW	SOD-323	Diodes Inc	1N4148WS-7
1	D5	SBR8U6 OP5	Switching Diode 60V 8A	POWERDI 5	Diodes Inc	SBR8U60P5

EV3910-K-00A BILL OF MATERIALS (continued)

Qty	Ref	Value	Description	Package	Manufacturer	Part Number
1	Q1	MMBTA06	NPN, 80V, 500mA	SOT-23	Fairchild	MMBTA06FSDKR-ND
1	Q2	SI7450	N-CH MOSFET 200V 5.3A	PowerPA K SO-8	Vishay	Si7450
1	Q3	TL431	REG VLT ADJ 2.5V	SOT-23-3	Zetex Inc	TL431
1	U1	MP3910GK	DC-DC Controller	MSOP10	MPS	MP3910GK
1	U2	PC817B	Photocoupler	SMD	SHARP	PC817B
1	T1	Transformer	POWER STAGE TRANSFORMER	SMD	Würth	7491194912
1	L1	0.47uH	IR=6.8A,Isat=14.5A	SMD	Würth	744 373 240 047

EVB TEST RESULTS

Performance waveforms are tested on the evaluation board.

$V_{IN}=48V$, $V_{OUT}=12V$, $I_{OUT}=2.5A$, $T_A=25^\circ C$, unless otherwise noted.

Efficiency vs. Load Current

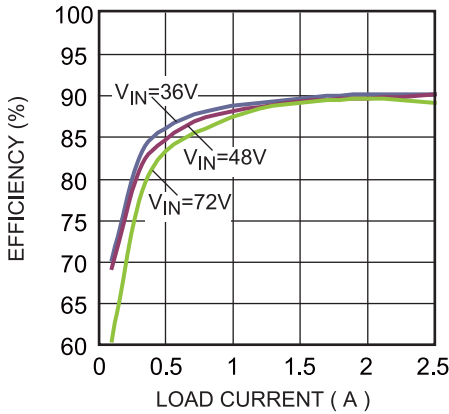

Load Regulation vs. Load Current

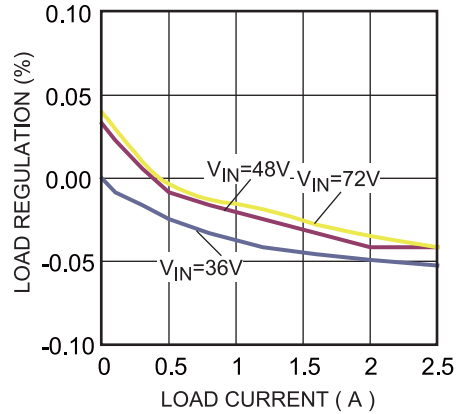

Line Regulation vs. Input Voltage

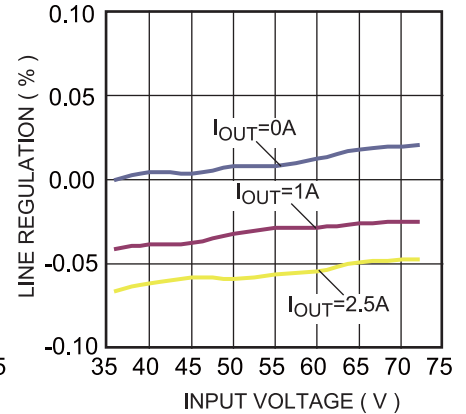

Gain and Phase vs. Frequency

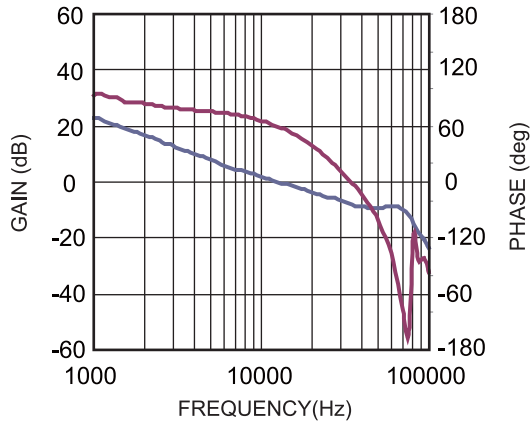

EVB TEST RESULTS (continued)

Performance waveforms are tested on the evaluation board.
 $V_{IN}=48V$, $V_{OUT}=12V$, $I_{OUT}=2.5A$, $T_A=25^\circ C$, unless otherwise noted.

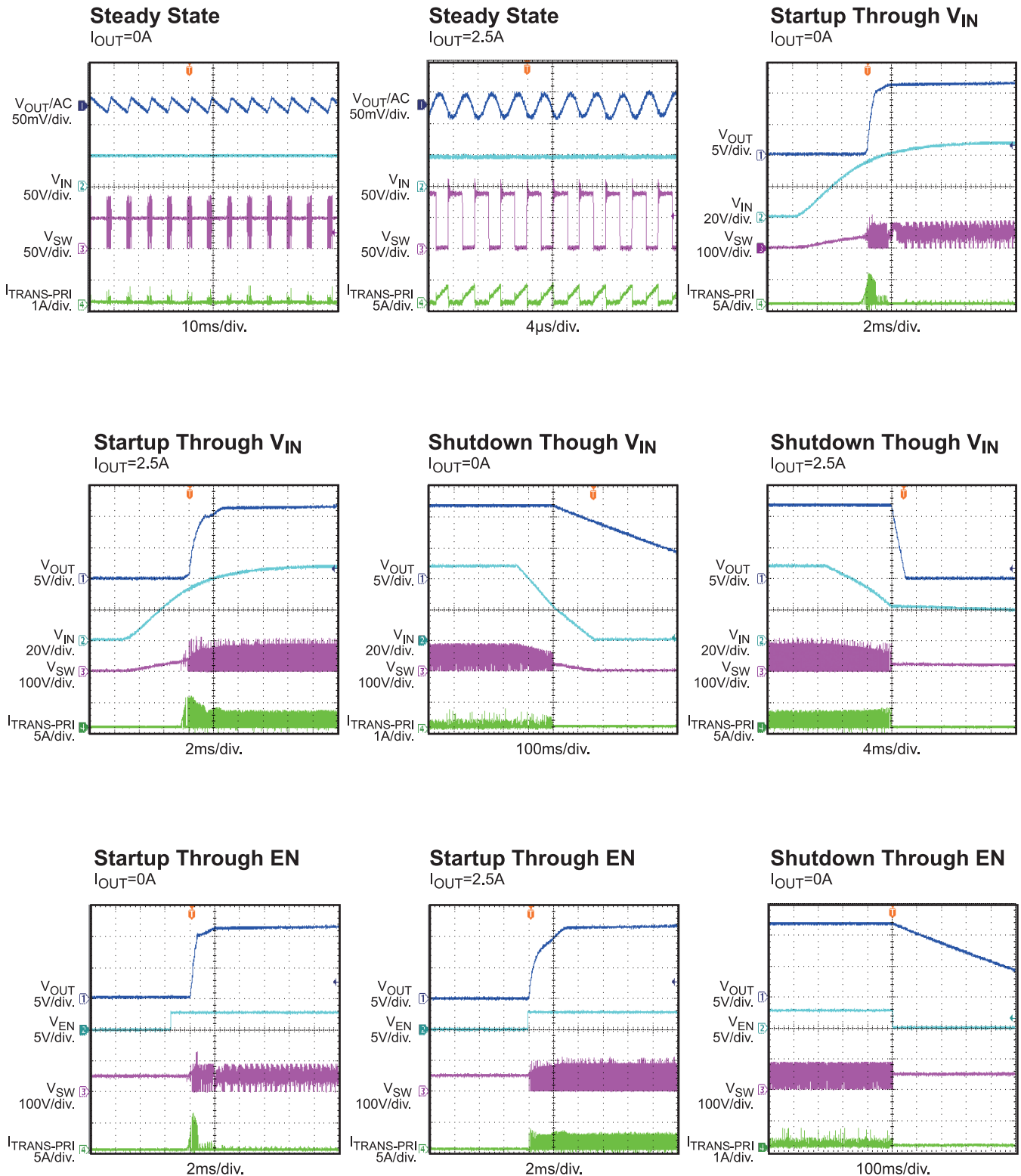

EVB TEST RESULTS *(continued)*

Performance waveforms are tested on the evaluation board.

$V_{IN}=48V$, $V_{OUT}=12V$, $I_{OUT}=2.5A$, $T_A=25^{\circ}C$, unless otherwise noted.

Shutdown Through EN

$I_{OUT}=2.5A$

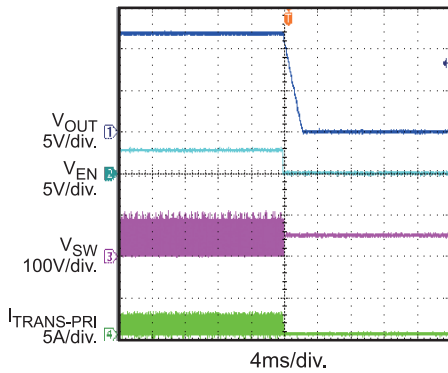

Load Transient

$I_{OUT}=1.25A \rightarrow 2.5A$. $I_{RAMP}=25mA/\mu s$

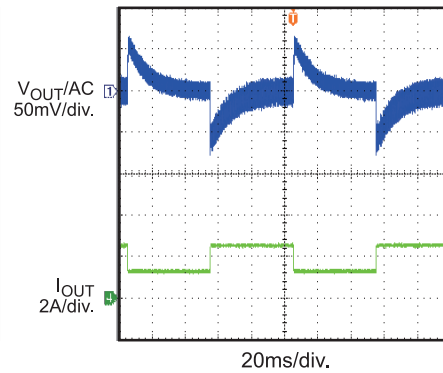

SCP Entry

$I_{OUT}=0A \rightarrow$ Short

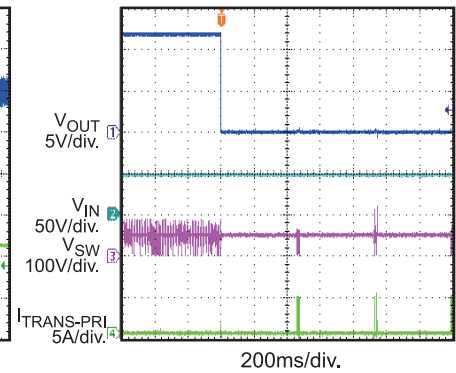

SCP Recovery

$I_{OUT}=\text{Short} \rightarrow 0A$

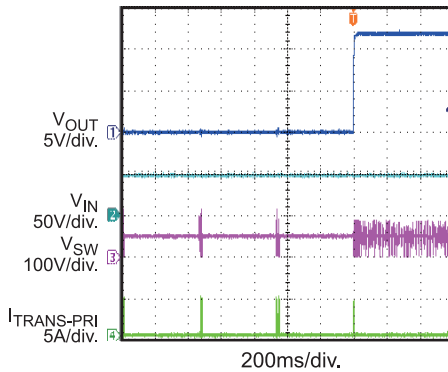

PRINTED CIRCUIT BOARD LAYOUT

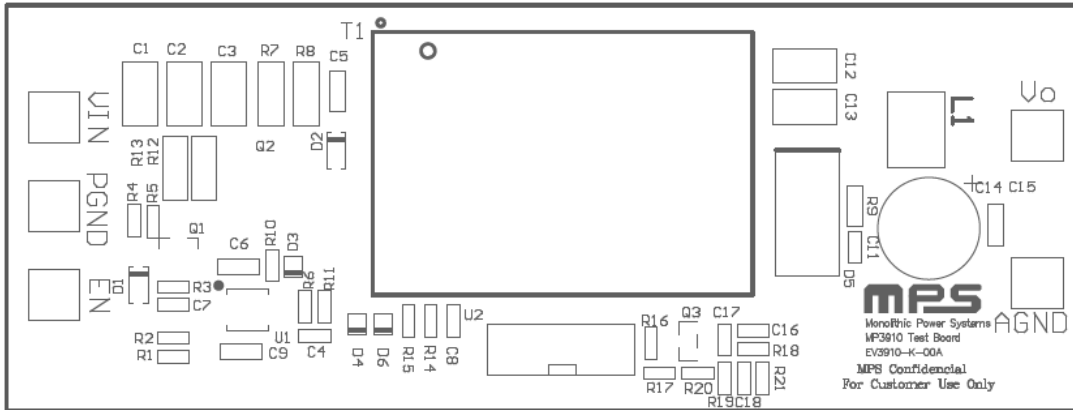

Figure 1: Top Silk Layer

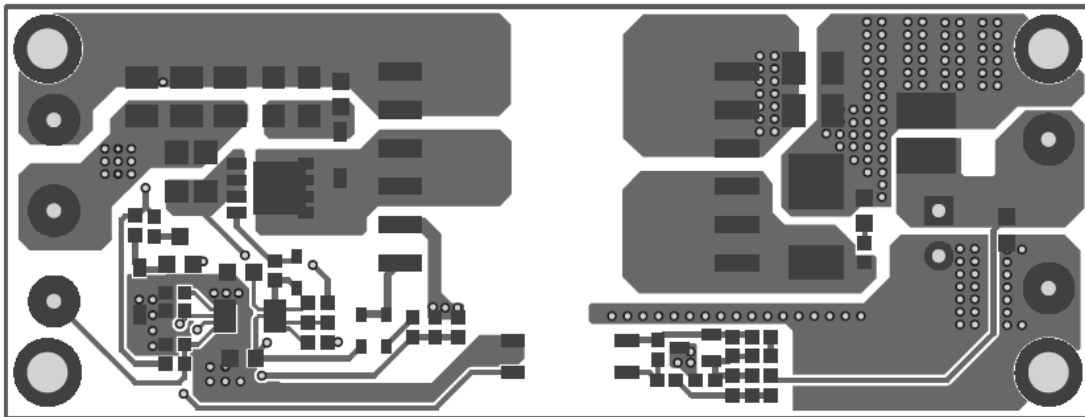

Figure 2: Top Layer

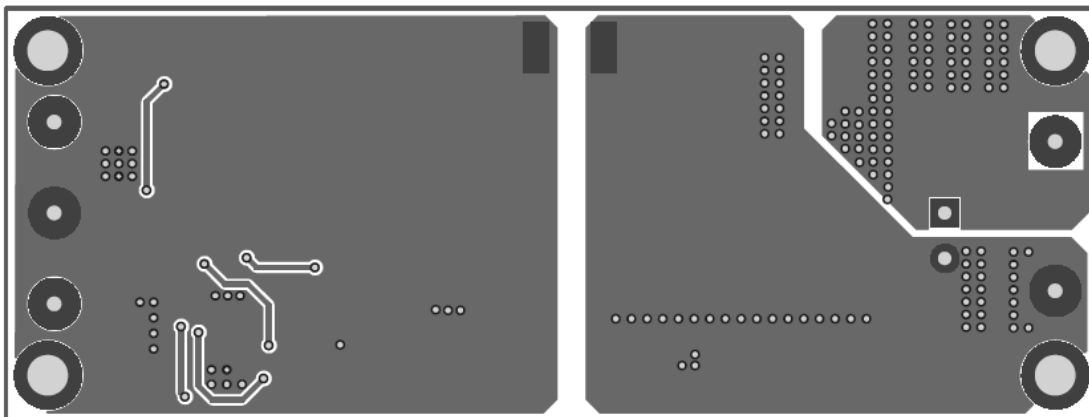

Figure 3: Bottom Layer

QUICK START GUIDE

1. Connect the positive and negative terminals of the load to the VOUT and GND pins respectively.
2. Preset the power supply output between 36V and 72V, and then turn off the power supply.
3. Connect the positive and negative terminals of the power supply output to the VIN and GND pins, respectively.
4. Turn the power supply on. The EV3910-K-00A will automatically startup.
5. To use the Enable function, apply a digital input to the EN pin. Drive EN higher than 2V to turn on the regulator or less than 1V to turn it off.

NOTICE: The information in this document is subject to change without notice. Please contact MPS for current specifications. Users should warrant and guarantee that third party Intellectual Property rights are not infringed upon when integrating MPS products into any application. MPS will not assume any legal responsibility for any said applications.