

DESCRIPTION

The EV4033-K-00B Evaluation Board is designed to demonstrate the capabilities of MP4033 with ripple suppressor. The MP4033 is a primary-side-control offline LED lighting controller which can achieve high power factor and accurate current for Triac dimmable LED lighting application. Its adaptive dimmer type detection and phase-cut-based dimming control can achieve good dimmer compatibility and deep dimming range.

It works in boundary conduction mode for reducing the MOSFET and Diode switching losses. The new ripple suppressor can obviously reduce the output current ripple and escape the flicker or shimmer happened in deep dimming situation with a little influence in efficiency.

The EV4033-K-00B is typically designed for driving an 8W Triac dimmable LED bulb with 24V_{TYP}, 350mA LED load from 108VAC to 132VAC, 50Hz.

The EV4033-K-00B has an excellent efficiency and meets IEC61547 surge immunity, IEC61000-3-2 Class C harmonics and EN55015 conducted EMI requirements. It has multi-protection function as over-voltage protection; winding short circuit protection; output short-circuit protection, cycle by cycle current limit, etc.

ELECTRICAL SPECIFICATION

Parameter	Symbol	Value	Units
Input Voltage	V _{IN}	108 to 132	VAC
Output Voltage	V _{OUT}	24	V
LED Current	I _{LED}	350	mA
Output Power	P _{OUT}	8.4	W
Efficiency (full load)	η	>81	%
Power Factor	PF	>0.9	
THD	THD	<20	%

FEATURES

- Fast Start up
- Adaptive Dimmer Type Detection and Phase-Cut-Based Dimming Control
- Triac Dimmable, with Good Dimmer Compatibility and Deep Dimming Range
- The Dimming Curve Meets Standard SSL6
- Direct PWM Dimming
- Real Current Control without Secondary-feedback Circuit
- Programmable Current Fold-back to Prolong the LED Lifetime (NTC)
- Accurate Line & Load Regulation
- High Power Factor over 198VAC to 265VAC
- Boundary Conduction Mode Improves Efficiency
- Input UVLO
- Cycle-by-cycle Current Limit
- Over-voltage Protection (OVP)
- Output Short-circuit Protection (SCP)
- Winding Short Circuit Protection
- ZCD Pin Short Circuit Protection
- Over-temperature Protection (OTP)
- Fit inside A19 Bulb Enclosure

APPLICATIONS

- Solid State Lighting
- Industrial & Commercial Lighting
- Residential Lighting

All MPS parts are lead-free and adhere to the RoHS directive. For MPS green status, please visit MPS website under Quality Assurance. "MPS" and "The Future of Analog IC Technology", are Registered Trademarks of Monolithic Power Systems, Inc.



Warning: Although this board is designed to satisfy safety requirements, the engineering prototype has not been agency approved. Therefore, all testing should be performed using an isolation transformer to provide the AC input to the prototype board.

EV4033-K-00B EVALUATION BOARD

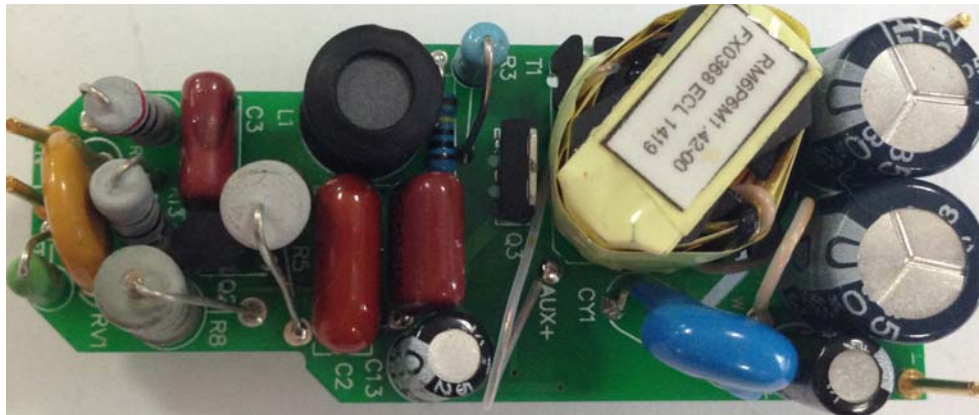
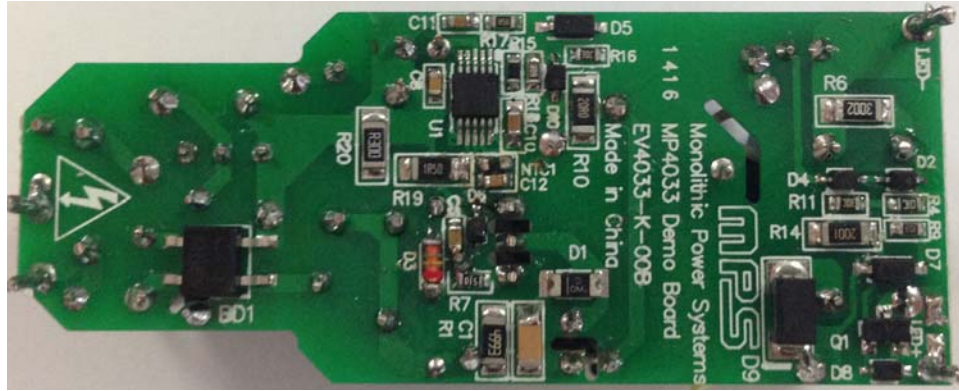

(L x W x H) 62mm x 25mm x 23mm

Board Number	MPS IC Number
EV4033-K-00B	MP4033GK

EVALUATION BOARD SCHEMATIC

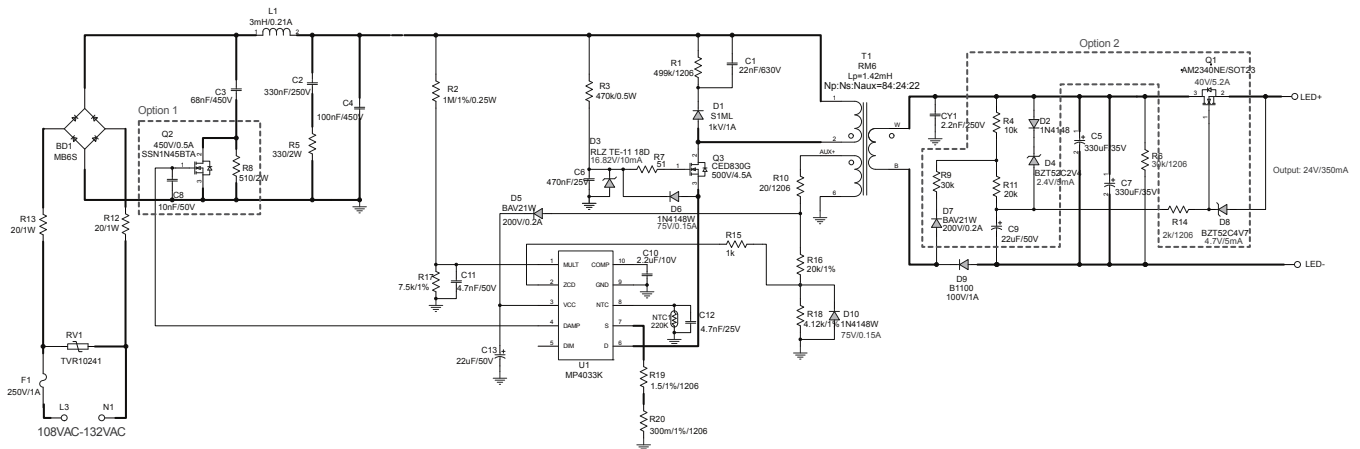

Figure 1—Schematic

PCB LAYOUT (SINGLE-SIDED)

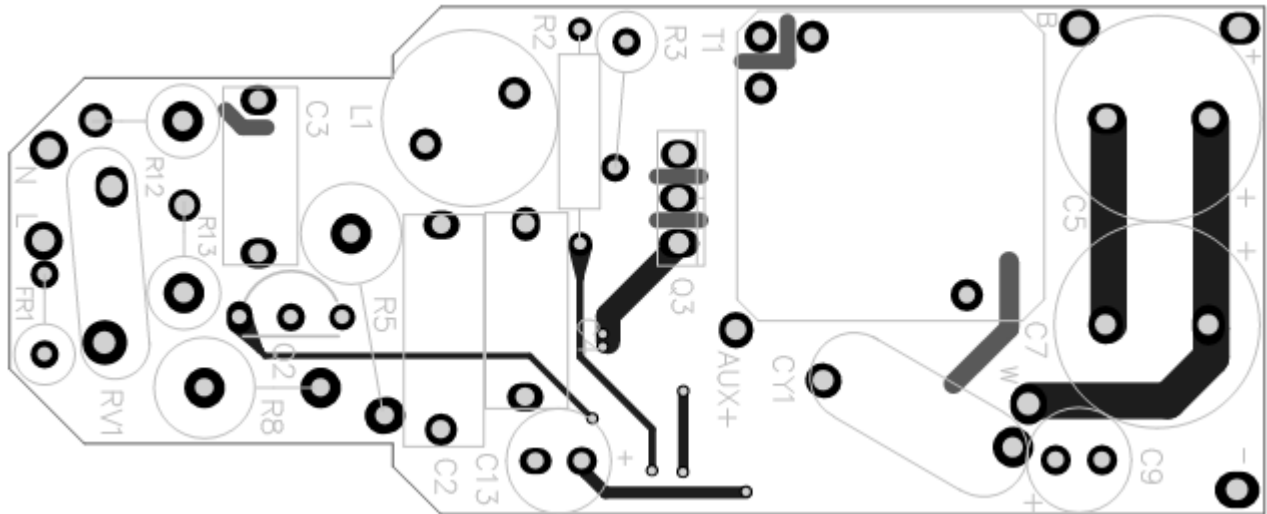

Figure 2—Top Layer

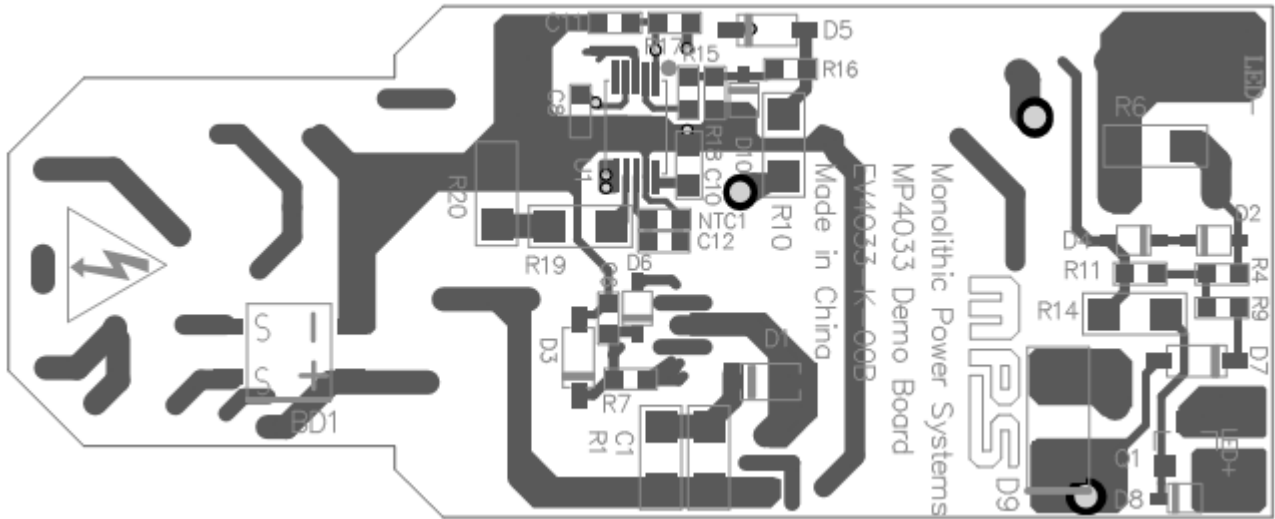

Figure 3—Bottom Layer

CIRCUIT DESCRIPTION

The EV4033-K-00B is configured in a single-stage Flyback topology; it uses primary-side-control which can mostly simplify the schematic and get a cost effective BOM. It can also achieve high power factor and accurate LED current.

F1, RV1, L1, R12, R13, C3, BD1 and C4 compose the input stage. F1 fuses the AC input to protect for the component failure or some excessive short events. RV1 is used for surge test. L1, R12, R13, C3 and C4 associated with CY1 form the EMI filter which can meet the standard EN55015. The diode rectifier BD1 rectifies the input line voltage. Small bulk CBB capacitor C4 is used for a low impedance path for the primary switching current, to maintain high power factor, the capacitance of C4 should be selected with low value.

R8, Q2 with C8 compose the damping circuit.. The dimmer compatibility is well without this circuit. It only helps to reduce the inrush current thro dimmer at the moment dimmer turning on. The circuit let the inrush current flow through R8 at the moment triac dimmer turning on. Then Q2 turns on and shorts R8, this can save power loss from R8.

R5, C2 are used as a bleeder circuit which keeping the triac current above the minimum holding current after triac turns on.

R2, R17, C11 provide sine wave reference for the primary peak current to get an active PFC function. The divided voltage should be lower than the max voltage rating of MULT pin.

R10, D5, and C13 are used to supply the power for MP4033. A 22 μ F bulk capacitor C13 is selected to maintain the supply voltage. At

start-up, C13 is first charged up through the external MOSFET Q3 and internal charging circuit, when the VCC voltage reaches 10V, the internal charging circuit stops charging. Then the power supply is taken over by the auxiliary winding through R10, D5.

R3, C6, R7, D3 and D6 are used for the gate drive of the external MOSFET Q3.

R16, R18 and D10 are used to detect the auxiliary winding to get the transformer magnetizing current zero crossing signal for realizing the boundary conduction operation, and also monitor the output OVP condition. The OVP voltage is set by the divider ratio of R16 and R18.

R19, R20 are primary sensing resistors for primary side current control. The value of R19, R20 set the output LED current. C1, R1, D1 are used to damp the leakage inductance energy so the drain voltage can be suppressed at a safe level.

Diode D9 rectifies the secondary winding voltage and the capacitor C5, C7 are the output filter. The resistor R6 is placed as pre-load to limit the output voltage rise too high in open load condition.

R4, R11, R9, R14, C9, D7, D2, D4, D8, and Q1 compose the ripple suppressor. R4, R11 and C9 offer a stable drive voltage to Q1. D2 and D4 compose the fast start up circuit, which help charge C9 quickly at the moment power on. D7, R9 and R4 add a bias voltage to the gate of Q1, which will help save the power loss of the ripple suppressor obviously.

EV4033-K-00B BILL OF MATERIALS

Qty	Ref	Value	Description	Package	Manufacturer	Manufacturer_P/N
1	BD1	MB6S	BRIDGE, 600V, 0.5A	SOIC-4	Taiwan Semiconductor	MB6S
1	C1	22nF/630V	Ceramic Cap, 630V, X7R	1206	TDK	C3216X7R2J223K
1	C2	330nF/250V	CBB,250V	DIP		CL21XX-250V-330N
1	C3	68nF/450V	683/450V	DIP	Fala	C222S683J30C000
1	C4	100nF/450V	104/450V	DIP	Fala	C222S104K30C000
2	C5, C7	330µF/35V	Electrolytic Capacitor, 35V, Electrolytic	DIP	JiangHai	CD263-35V330
1	C6	470nF/50V	Ceramic Cap,X7R,50V	0603	muRata	GRM188R71E474KA12D
1	C13	22µF/50V	Electrolytic Capacitor; 50V;Electrolytic	DIP	Jianghai	CD281L-50V22
1	C10	2.2µF/10V	Ceramic Cap,10V,X7R	0603	muRata	GRM188R71A225KE15D
2	C11, C12	4.7nF/50V	Ceramic Cap,X7R,50V	0603	muRata	GRM188R71H472KA01D
1	CY1	2.2nF/4000V	Y Capacitor,4000V	DIP	Hongke	JNK12E222MY02N
1	D1	WSGC10MH	Diodes,1000V,1A	SOD-123	ZOWIE	WSGC10MH
1	D3	RLZ TE-11 18D	Zener DIODES/16.82V, 10mA	SOD-123	ROHM	RLZ TE-11 18D
1	D5	BAV21W	Diode;200V;0.2A;	SOD-123	Diodes	BAV21W-7-F
2	D6, D10	1N4148WS	Diode;75V;0.15A;	SOD-323	Diodes	1N4148WS-7-F
1	D9	B1100	Diode;100V;1A	SMA	Diodes	B1100-13-F
1	F1	250V/1A	Fuse	DIP	any	
1	L1	Inductor,3mH	Inductor,3mH/DR8*10	DIP	Hulsin	HDR0810-302M
1	NTC	220kΩ	Thermistor	0603	muRata	MCP13WM224E03R8
1	Q3	CED830G	N-Channel MOSFET, 500V, 4.5A	TO-251	CET	CED830G
1	R1	499kΩ	Film RES, 1%	1206	Yageo	RC1206FR-07499KL
1	R2	1MΩ	DIP,0.25W RESISTOR	DIP	any	1MΩ/0.25W
1	R3	470kΩ/0.5W	Resistor;5%;0.5W	DIP	any	470kΩ/0.5W
1	R5	330Ω	DIP,2W RESISTOR	DIP	any	330Ω/2W
1	R6	30kΩ	Resistor;1%	1206	Yageo	RC1206FR-0730kL
1	R7	51Ω	Film RES,1%	0603	Yageo	RC0603FR-0751RL
1	R10	20Ω	Film RES;1%	1206	Yageo	RC1206FR-0720RL
2	R12, R13	20Ω	DIP,1W RESISTOR	DIP	any	20Ω/1W
1	R15	1kΩ	Film RES, 1%	0603	Yageo	RC0603FR-071KL
1	R16	20kΩ	Film RES, 1%	0603	Yageo	RC0603FR-0720kL
1	R17	7.5kΩ	Film RES, 1%	0603	Yageo	RC0603FR-077K5L
1	R18	4.12kΩ	Film RES, 1%	0603	Yageo	RC0603FR-074K12L

EV4033-K-00B BILL OF MATERIALS (continued)

Qty	Ref	Value	Description	Package	Manufacturer	Manufacturer_P/N
1	R19	1.5Ω	Film RES, 1%	1206	Royalohm	1206F150KT5E
1	R20	300mΩ	Film RES, 1%	1206	Yageo	RL1206FR-070R3L
1	RV1	TVR10241KSY	240V/2500A	DIP	TKS	TVR10241KSY
1	T1	RM6	RM6, Lp=1.42mH Np:Ns:Naux=84:24:22,	RM6	Emei	FX0368
1	U1	MP4033GK	MP4033GK	MSOP10	MPS	MP4033GK R2
1	R8	510Ω	DIP, 2W RESISTOR	DIP	any	510Ω/2W
1	Q2	SSN1N45BTA	N-Channel Mosfet450V;4250/10V; 8.5	TO-92	Fairchild	SSN1N45BTA
1	C8	10nF/50V	Ceramic Cap,X7R,50V	0603	muRata	GRM188R71H103KA01D
1	C9	22uF/50V	Electrolytic Capacitor;50V;Electrol ytic	DIP	Jianghai	CD281L-50V22
1	D2	1N4148WS	Diode;75V;0.15A;	SOD- 323	Diodes	1N4148WS-7-F
1	D7	BAV21W	Diode;200V;0.2A;	SOD- 123	Diodes	BAV21W-7-F
1	D8	BZT52C4V7S	Zener Diode, 4.7V, 5mA	SOD- 323	Diodes	BZT52C4V7S
1	D4	BZT52C2V4S	Zener Diode, 2.4V, 5mA	SOD- 323	Diodes	BZT52C2V4S
1	Q1	AM2340NE	N-channel MOSFET, 40V,5.2A	SOT23	Analog Power	AM2340NE
1	R4	10kΩ	Film RES;1%	0603	Yageo	RC0603FR-0710KL
1	R9	30kΩ	Film RES;1%	0603	Yageo	RC0603FR-0730KL
1	R11	20kΩ	Film RES;1%	0603	Yageo	RC0603FR-0720KL
1	R14	2kΩ	Film RES;1%	1206	Yageo	RC1206FR-072KL

Note:

1. The components in **red** compose the damping circuit, which is used to reduce the inrush current with leading edge dimmer. It is optional.
2. The components in **blue** compose the ripple suppressor. It is optional.

TRANSFORMER SPECIFICATION

Electrical Diagram

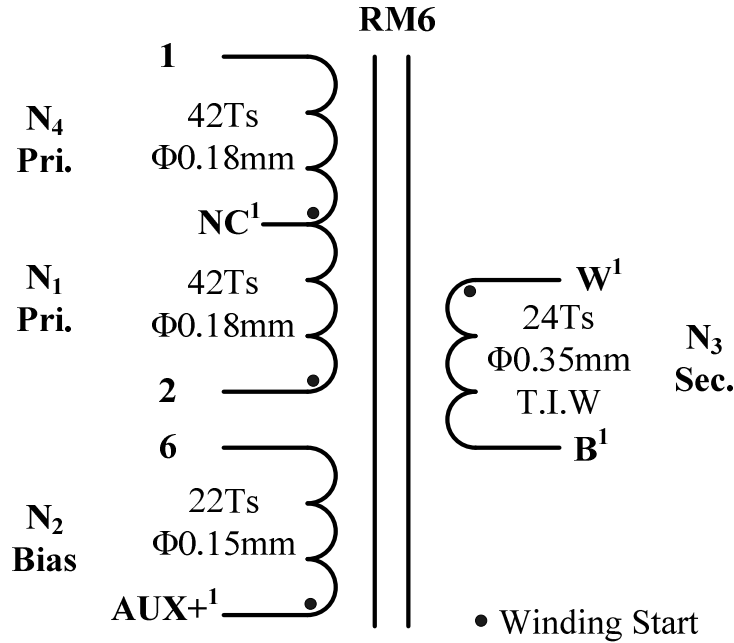

Figure 4—Transformer Electrical Diagram

Notes:

1. Don't connect NC to any pin of Bobbin.
2. W and B are pulled out and marked with different Teflon tube.

Winding Diagram

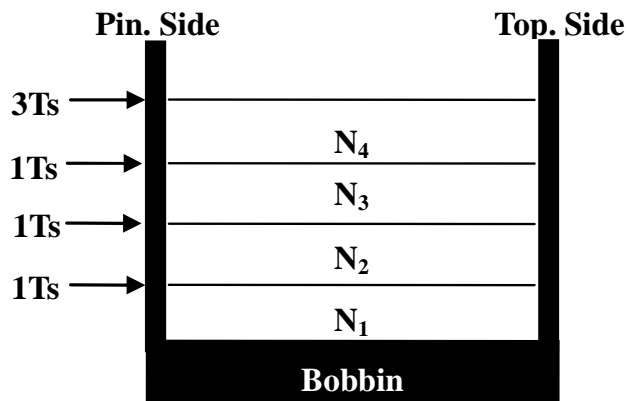

Figure 5—Winding Diagram

Winding Order

Winding No.	Tape Layer Number	Start & End	Magnet Wire Φ (mm)	Turns
N ₁	0	2→NC	0.18mm * 1	42
N ₂	1	Aux+→6	0.15mm * 1	22
N ₃	1	W→B	0.35mm (T.I.W)	24
N ₄	1	NC→1	0.18mm * 1	42

Electrical Specifications

Electrical Strength	60 second, 60Hz, from PRI. to SEC.	2500VAC
	60 second, 60Hz, from PRI. to CORE.	1000VAC
	60 second, 60Hz, from SEC. to CORE.	1000VAC
Primary Inductance	Pins 1 - 2, all other windings open, measured at 100kHz, 0.1 VRMS	1.42mH±8%
Primary Leakage Inductance	Pins 1 - 2 with all other pins shorted, measured at 100kHz. 0.1 VRMS	23μH±10%

Materials

Item	Description
1	Core: RM6, UI=2500±25%, AL=221.5H/N ² ±2% GAP, ACME P4 or equivalent
2	Bobbin: RM6, 3+3PIN RMMOVE PIN6 1SECT TH, PM9630 UL94V-0
3	Wire: Φ 0.16mm, 2UEW, CLASS F or equivalent
4	Triple Insulation Wire: great Φ 0.35mm, TRW(B) or equivalent
5	TEFLON TUBE: TFL AWG#30
6	TEFLON TUBE: TFL AWG#24
7	Tape: 6.5mm(W)×0.06mm(TH)
8	Tape: 4.0mm(W)×0.06mm(TH)
9	Varnish: JOHN C. DOLPH CO, BC-346A or equivalent
10	Solder Bar: CHEN NAN: SN99.5/Cu0.5 or equivalent

EVB TEST RESULTS

Performance Data

Efficiency, PF and THD

f (Hz)	Vin(V)	Pin(W)	Vo(V)	Io(mA)	Po(W)	Efficiency(%)	PF	THD(%)
60	90	10.24	23.62	353	8.34	81.42	0.985	12.10
	100	10.10	23.62	354	8.36	82.79	0.978	13.70
	110	10.00	23.62	355	8.39	83.85	0.970	14.60
	120	9.98	23.62	356	8.41	84.26	0.960	16.00
	132	9.96	23.62	357	8.43	84.66	0.945	17.50

Dimming Compatibility (No Flicker with these 32 different Dimmers)

Manufacturer	Part No.	Power Stage	I _{max} (mA)	I _{min} (mA)	Dimming ratio
LUTRON	Q-600P-IV	600W	357	22	6.16%
LUTRON	CN-600P	600W	357	11	3.08%
LUTRON	AY-600P	600W	356	17	4.78%
LUTRON	SLV-600P	600W	356	13	3.65%
LUTRON	LG-600P	600W	356	9	2.53%
LUTRON	6B38-Q-600P	600W	355	19	5.35%
LUTRON	GL-600H-DK	600W	358	5	1.40%
LEVITON	1G4005	600W	358	0	0.00%
LEVITON	1I2005	600W	357	0	0.00%
LUTRON	GLV02-F06392	600W	358	0	0.00%
LEVITON	6633-P	600W	357	0	0.00%
LUTRON	6B38-S-600P	600W	358	3	0.84%
LUTRON	CT-600P	600W	354	4	1.13%
LUTRON	6B38-S-603PG	600W	297	5	1.68%
LUTRON	6B38-DV-600P	600W	354	4	1.13%
LUTRON	DVCL-153P	600W	357	42	11.76%
LUTRON	6B38-DVLV-600P	600W	354	13	3.67%
LEVITON	1L1005	600W	357	0	0.00%
LUTRON	GLS01-C06570	600W	302	0	0.00%
LUTRON	DV-600P-BR	600W	354	7	1.98%
LEVITON	6613-PL	600W	357	0	0.00%
LEVITON	C20-6684-IW	600W	356	0	0.00%
LUTRON	AY-600P-LA	600W	355	27	7.61%
LUTRON	TG-600PH-WH	600W	354	21	5.93%
LUTRON	TG-603GH-WH	600W	261	18	6.90%
LUTRON	S-600	600W	357	6	1.68%
LUTRON	DVPDC-203P-WH	200W	357	63	17.65%
LUTRON	S-600P	600W	357	3	0.84%
LUTRON	6B38-DV-603PG	600W	284	12	4.23%
LUTRON	DNG-603PH-WH	400W	357	0	0.00%
COOPER	6B28	600W	357	0	0.00%
LEVITON	6633-P-1G1005	600W	357	2	0.56%

Electric Strength Test

Primary circuit to secondary circuit electric strength testing was completed according to IEC61347-1 and IEC61347-2-13.

Input and output was shorted respectively. 3750VAC/50Hz sine wave applied between input and output for 1min, and operation was verified.

Surge Test

Line to Line 500V and Line to Power Earth 1kV surge testing was completed according to IEC61547. Input voltage was set at 120VAC/60Hz. Output was loaded at full load and operation was verified following each surge event.

Surge Level (V)	Input Voltage (VAC)	Injection Location	Injection Phase (°)	Test Result (Pass/Fail)
500	120	L to N	90	Pass
-500	120	L to N	270	Pass
1000	120	L to PE	90	Pass
-1000	120	L to PE	270	Pass
1000	120	N to PE	90	Pass
-1000	120	N to PE	270	Pass

Thermal Test

Test without dimmer and with dimmer at 90% dimming on phase.

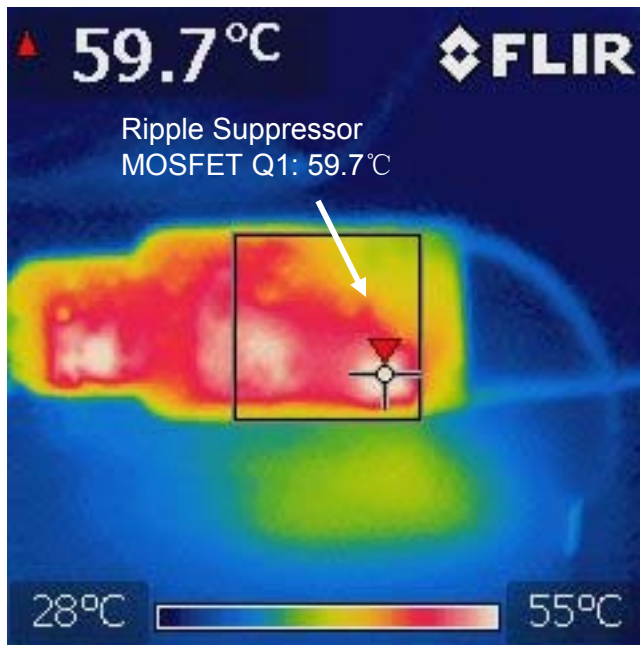

Without dimmer

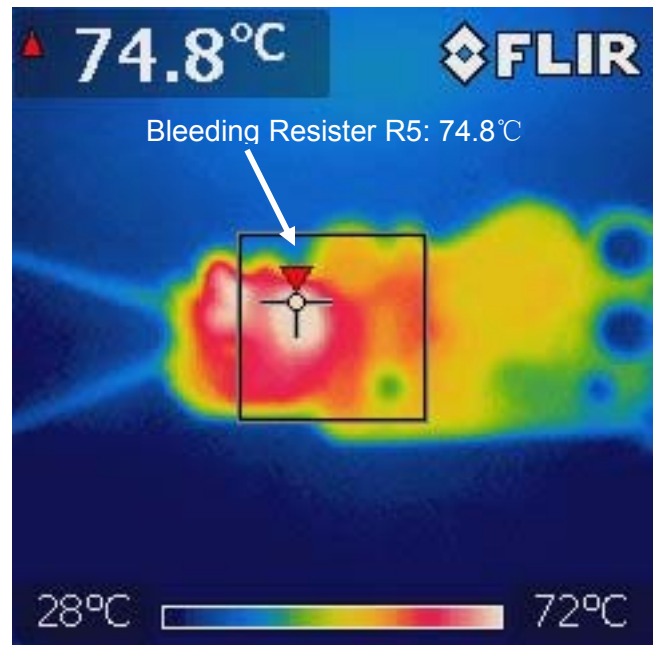

With dimmer at 90% dimming on phase

EVB TEST RESULTS

Performance waveforms are tested on the evaluation board.

$V_{IN}=120V_{AC}/60Hz$, 8 LEDs in series, $I_{LED}=350mA$, $V_{OUT}=24V$, $L_P=1.42mH$, $N_P:N_S:N_{AUX}=84:24:22$

Conducted EMI L-Line

$V_{IN} = 120V_{AC}/60Hz$, Full Load,
RBW = 9kHz, MT = 20ms

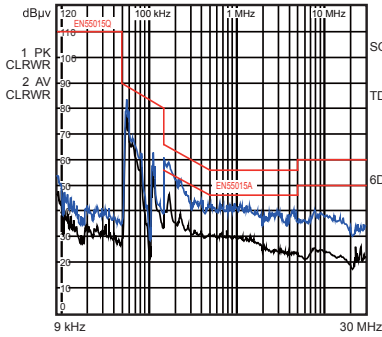

Conducted EMI N-Line

$V_{IN} = 120V_{AC}/60Hz$, Full Load,
RBW = 9kHz, MT = 20ms

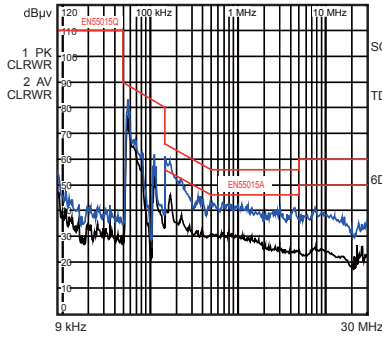

Dimming Curve

$V_{IN}=120V_{AC}/60Hz$, Full Load,
with Different Dimmers

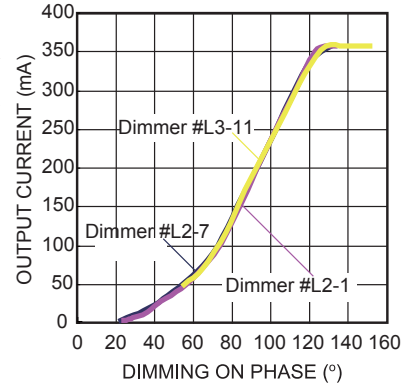

Line Regulation

Full Load

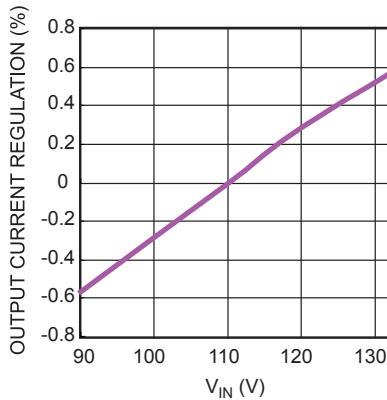

Efficiency vs. V_{IN}

$V_{IN} = (90-132)V_{AC}/60Hz$, Full Load

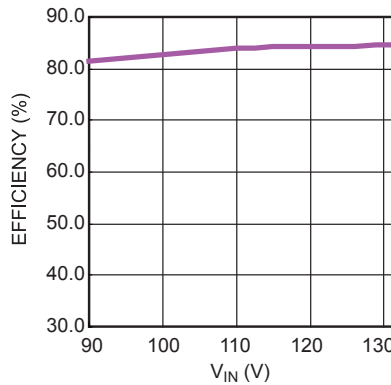

PF vs. V_{IN}

$V_{IN} = (90-132)V_{AC}/60Hz$, Full Load

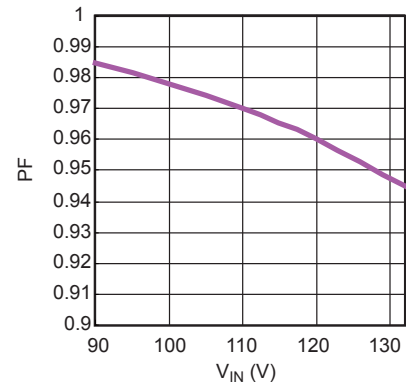

THD vs. V_{IN}

$V_{IN} = (90-132)V_{AC}/60Hz$, Full Load

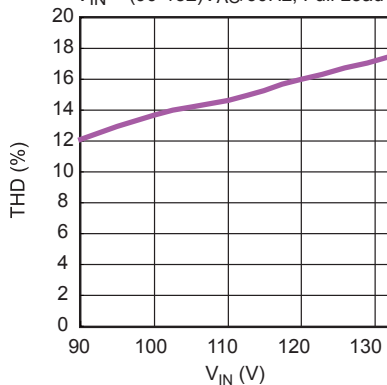

EVB TEST RESULTS (continued)

Performance waveforms are tested on the evaluation board.

 $V_{IN}=120V_{AC}/60Hz$, 8 LEDs in series, $I_{LED}=350mA$, $V_{OUT}=24V$, $L_P=1.42mH$, $N_P:N_S:N_{AUX}=84:24:22$.

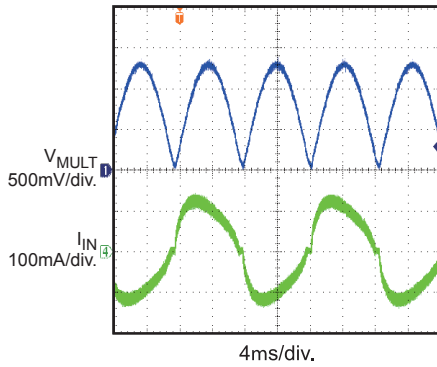
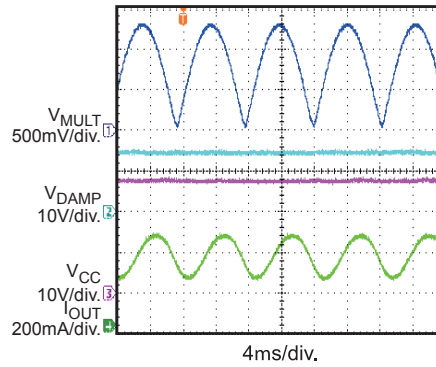
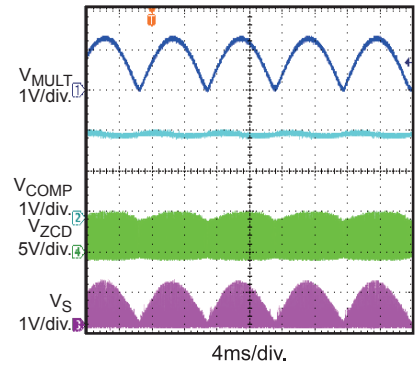
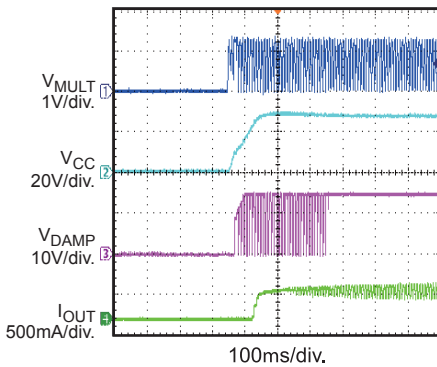
Input Voltage and Current
 $V_{IN}=120V_{AC}/60Hz$, Full Load

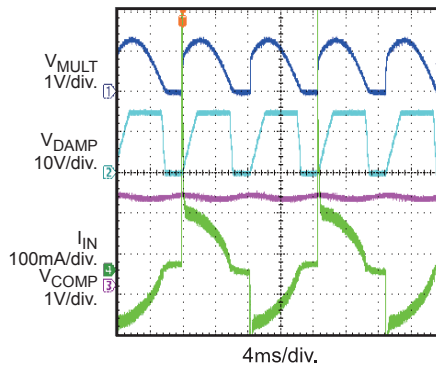
Steady State
 $V_{IN}=120V_{AC}/60Hz$, Full Load

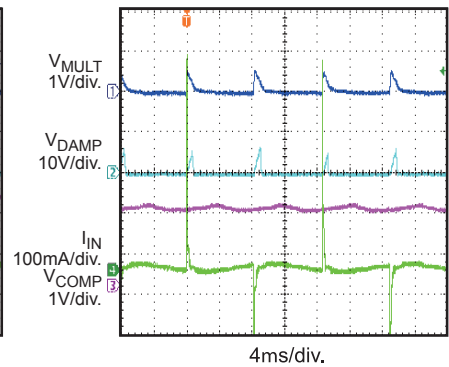
Steady State
 $V_{IN}=120V_{AC}/60Hz$, Full Load

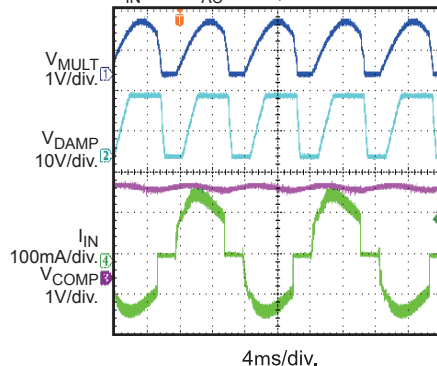
V_{IN} Start Up
 $V_{IN}=120V_{AC}/60Hz$, Full Load

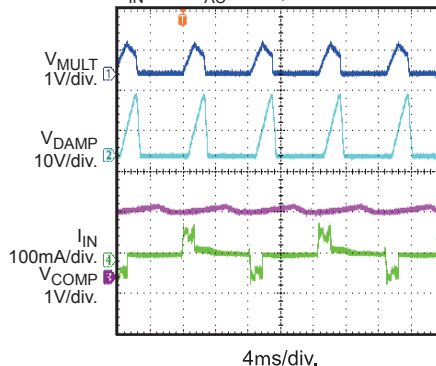
Dimming Performance

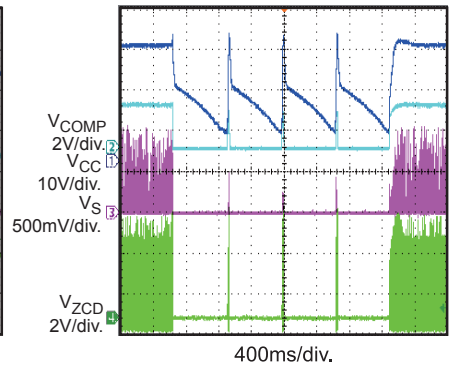
 Max dimming on phase with leading-edge dimmer
 $V_{IN}=120V_{AC}/60Hz$, with dimmer

Dimming Performance

 Min dimming on phase with leading-edge dimmer
 $V_{IN}=120V_{AC}/60Hz$, with dimmer

Dimming Performance

 Max dimming on phase with trailing-edge dimmer
 $V_{IN}=120V_{AC}/60Hz$, with dimmer

Dimming Performance

 Min dimming on phase with trailing-edge dimmer
 $V_{IN}=120V_{AC}/60Hz$, with dimmer

OVP

 LED Load Open then Recovery
 $V_{IN}=120V_{AC}/60Hz$, Full Load

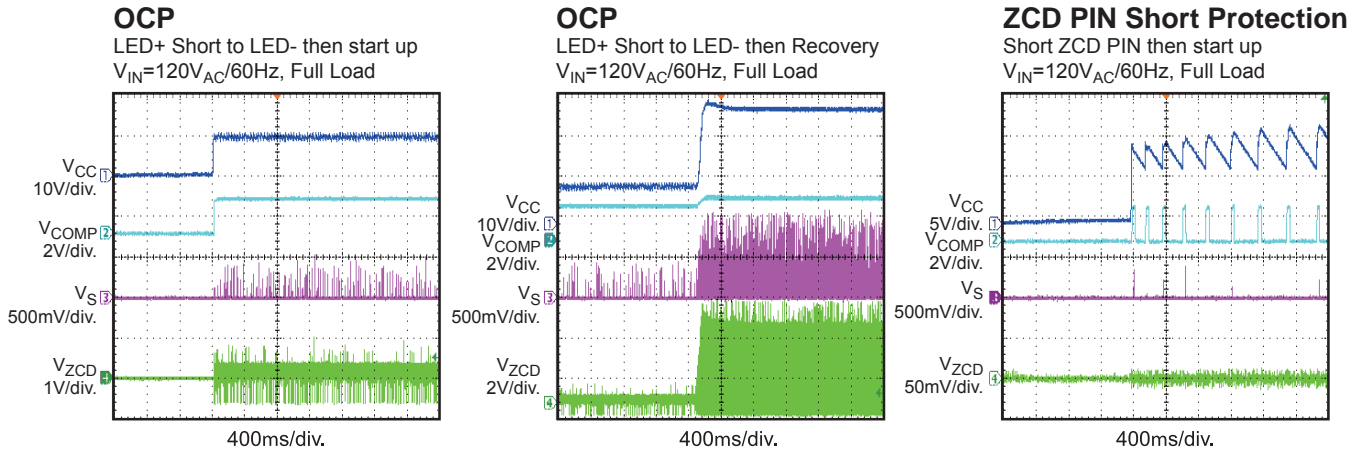
EVB TEST RESULTS (continued)

Performance waveforms are tested on the evaluation board.

 $V_{IN}=120V_{AC}/60Hz$, 8 LEDs in series, $I_{LED}=350mA$, $V_{OUT}=24V$, $L_P=1.42mH$, $N_P:N_S:N_{AUX}=84:24:22$.

QUICK START GUIDE

1. Preset AC Power Supply to $108\text{VAC} \leq V_{\text{IN}} \leq 132\text{VAC}$.
2. Turn Power Supply off.
3. Connect the LED string between “LED+” (anode of LED string) and “LED-” (cathode of LED string).
4. Connect Power Supply terminals to AC V_{IN} terminals as shown on the board.
5. Turn AC Power Supply on after making connections.

NOTICE: The information in this document is subject to change without notice. Users should warrant and guarantee that third party Intellectual Property rights are not infringed upon when integrating MPS products into any application. MPS will not assume any legal responsibility for any said applications.