



The Future of Analog IC Technology®

EV4060-K-00A

198VAC~265VAC/50Hz, 72V/125mA

Non-isolated with Active PFC

TRIAC Dimmable LED Driver Evaluation Board

DESCRIPTION

The EV4060-K-00A Evaluation Board is designed to demonstrate the capabilities of MP4060. The MP4060 is a TRIAC dimmable LED controller with excellent dimming performance. The dimming control method is optimized for high input AC voltages ranging from 198VAC to 265VAC.

It works in boundary conduction mode for reducing the MOSFET and Diode switching losses. Its adaptive dimmer type detection and phase-cut-based dimming control can achieve good dimmer compatibility and deep dimming range. The active bleeder control circuit is integrated in BD pin to simplify the external bleeder design.

The EV4060-K-00A is typically designed for driving a 9W Triac dimmable LED bulb with 72V_{TYP}, 125mA LED load from 198VAC to 265VAC, 50Hz.

The EV4060-K-00A has an excellent efficiency and meets IEC61547 surge immunity, IEC61000-3-2 Class C harmonics and EN55015 conducted EMI requirements. It has multi-protection function as over-voltage protection; winding short circuit protection; output short-circuit protection; over-temperature protection; integrated thermal foldback etc.

ELECTRICAL SPECIFICATION

Parameter	Symbol	Value	Units
Input Voltage	V _{IN}	198 to 265	VAC
Output Voltage	V _{OUT}	72	V
LED Current	I _{LED}	125	mA
Output Power	P _{OUT}	9	W
Efficiency (full load)	η	>85	%
Power Factor	PF	>0.78	
THD	THD	<36	%

FEATURES

- Adaptive Dimmer Type Detection and Phase-Cut-Based Dimming Control
- Active Bleeder Control Circuit Integrated
- Good Dimmer Compatibility and Deep Dimming Range
- Fast Start-Up without Perceptible Delay
- Integrated Thermal Current Foldback to Prolong the LED Lifetime
- Accurate Line & Load Regulation
- High Power Factor
- Operates in Boundary Conduction Mode
- Cycle-by-Cycle Current Limit
- Winding Short-Circuit Protection
- Output Over-Voltage Protection
- Output Short-Circuit Protection
- Over-Temperature Protection
- Fit inside A19 Bulb Enclosure

APPLICATIONS

- Solid State Lighting
- Industrial & Commercial Lighting
- Residential Lighting

All MPS parts are lead-free, halogen free, and adhere to the RoHS directive. For MPS green status, please visit MPS website under Quality Assurance.

“MPS” and “The Future of Analog IC Technology” are Registered Trademarks of Monolithic Power Systems, Inc.



High Voltage

Warning: Although this board is designed to satisfy safety requirements, the engineering prototype has not been agency approved. Therefore, all testing should be performed using an isolation transformer to provide the AC input to the prototype board.

EV4060-K-00A EVALUATION BOARD



(L x W x H) 49.5mm x 26.4mm x 16.9mm

Board Number	MPS IC Number
EV4060-K-00A	MP4060GK

EVALUATION BOARD SCHEMATIC

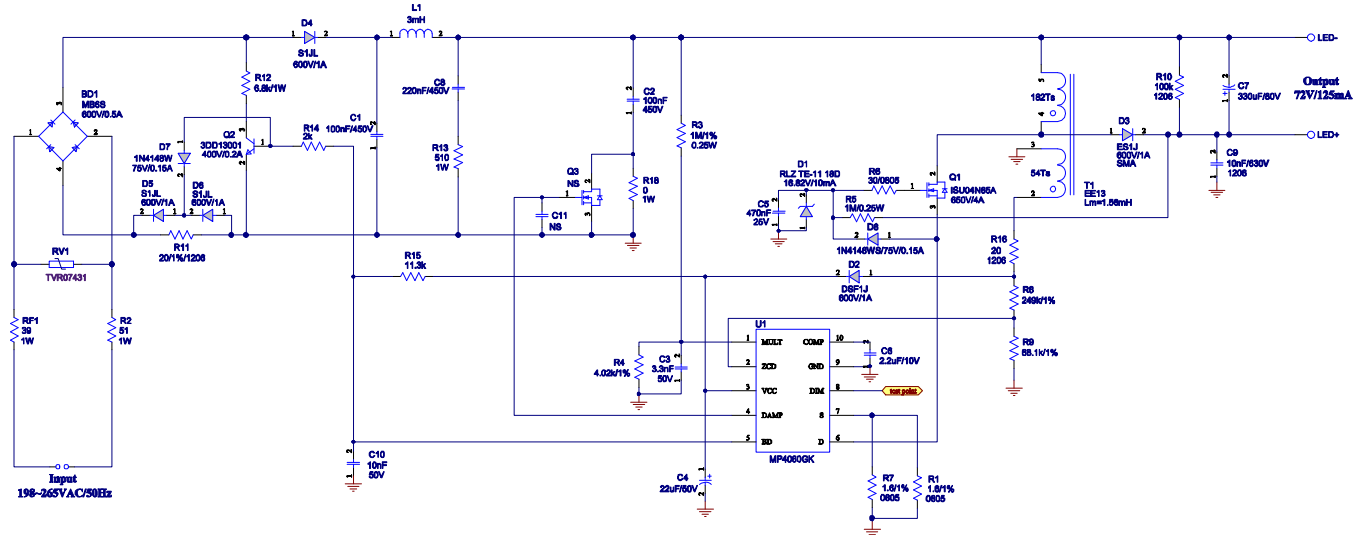

Figure 1—Schematic

PCB LAYOUT (SINGLE-SIDED)

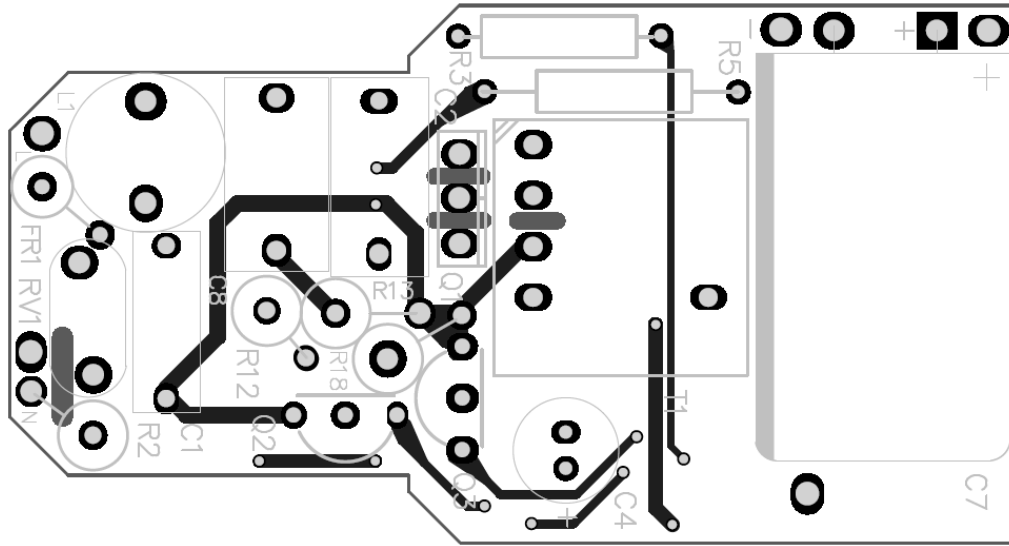

Figure 2—Top Layer

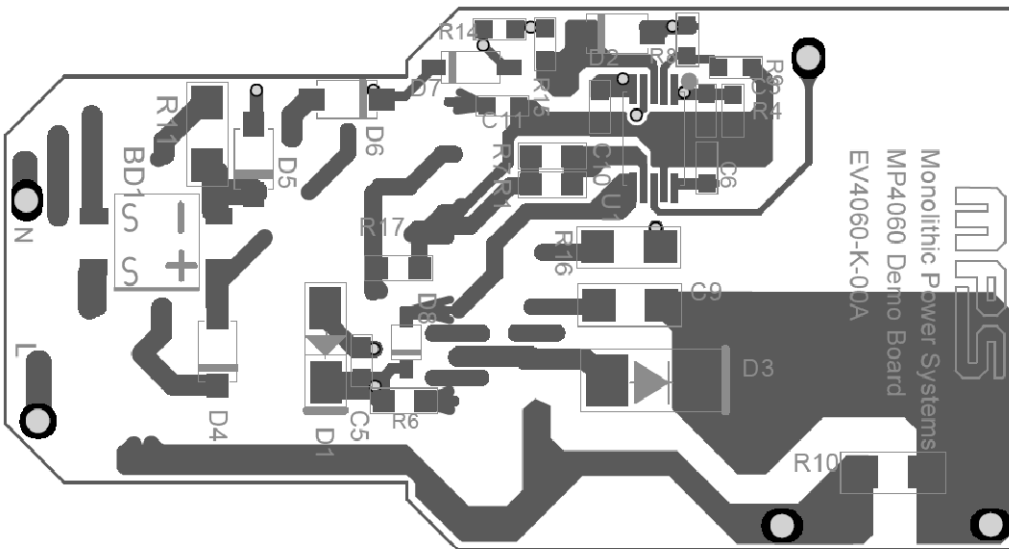

Figure 3—Bottom Layer

CIRCUIT DESCRIPTION

The EV4060-K-00A is configured in a single-stage Buck-boost topology and gets a cost effective BOM. It achieves high power factor and excellent TRIAC dimming performance.

FR1, R2, RV1 and BD1 compose the input stage. The fusible resistor FR1 fuses the AC input to protect the component failure or some excessive short events, its resistance associated with R2 are used as a passive damper of dimming. RV1 is used for surge test. The diode rectifier BD1 rectifies the input line voltage.

D4, D5, D6, D7, Q2, R12, R14, R15, C10 with the control signal BD compose the active bleeder circuit. The circuit is enabled when dimming condition is detected, it monitors the input current by resistor R11 and provides bleeding current through resistor R12 when the input current drops to low, so the input current will be kept in a high level to maintain the TRIAC dimmer turn on and avoid any random flickers.

C1, L1 and C2 form a π EMI filter. C8, R13 are used as a passive bleeder which also help keep the TRIAC current above the minimum holding current after TRIAC turns on.

R3, R4, C3 provide sine wave reference for the current control loop to get an active PFC function.

R16, D2 and C4 are used to supply the power for MP4060. A 22 μ F electrolytic capacitor C4 is selected to maintain the supply voltage. At start-up, C4 is first charged up through the external MOSFET Q1 and internal charging circuit, when the VCC voltage reaches VCC_{EN} , the internal charging circuit stops charging. Then the power supply is taken over by the auxiliary winding through R16, D2.

R5, C5, D1, and D8 are used for the gate drive of the external MOSFET Q1. R6 is used to adjust the driver capability for better EMI and small power loss.

R8 and R9 are used to detect the auxiliary winding to get the transformer magnetizing current zero crossing signal for realizing the boundary conduction operation, and also monitor the output OVP condition. The OVP voltage is set by the divider ratio of R8 and R9.

R1, R7 are sensing resistors for current control. The value of R1 and R7 set the output LED current.

Diode D3 is the output rectifying diode. The capacitor C7 is the output filter. The resistor R10 is placed as a dummy load to consume the output power in open load condition. The C9 is used to help improve the EMI performance.

EV4060-K-00A BILL OF MATERIALS

Qty	Ref	Value	Description	Package	Manufacturer	Manufacturer_P/N
2	C1, C2	100nF/450 V	CBB;450V	DIP	Fala	C222S104K30C000
1	C3	3.3nF/50V	Ceramic Capacitor;50V;X7R	0603	TDK	C1608X7R1H332K
1	C4	22uF/50V	Electrolytic Capacitor;50V	DIP	Jianghai	CD281L-50V22
1	C5	470nF/25V	Ceramic Capacitor;25V;X7R	0603	muRata	GRM188R61E474KA1 2
1	C6	2.2uF/10V	Ceramic Capacitor;10V;X7R	0603	muRata	GRM188R71A225KE1 5D
1	C7	330uF/80V	Electrolytic Capacitor;80V	DIP	YMIN	LK 330uF/80V
1	C8	220nF/450 V	CBB;450V	DIP	Fala	C222S224K31C000
1	C9	10nF/630V	Ceramic Capacitor;630V;X7R	1206	muRata	GRJ31BR72J103KWJ 1L
1	C10	10nF/50V	Ceramic Capacitor;50V;X7R	0603	muRata	GRM188R71H103KA0 1D
1	C11	NS				
1	D1	RLZTE- 1118D	Zener Diode;16.82V;10mA;	LLDS	ROHM	RLZTE-1118D
1	D2	DSF1J	Diode;600V;1A	SOD- 123FL	SHENXINYUA N	DSF1J
1	D3	ES1J	Diode;600V;1A	SMA	MCC	ES1J
3	D4, D5, D6	S1JL	Diode;600V;1A	SMA	Taiwan semi	S1JL
1	D7	1N4148W	Diode;75V;0.15A	SOD-123	Diodes	1N4148W
1	D8	1N4148WS	Diode;75V;0.15A	SOD-323	Diodes	1N4148WS-7-F
1	BD1	MB6S	Rectifier Bridge;600V;0.5A	SOIC-4	Taiwan semi	MB6S
1	L1	3mH	HDR0608-302M	DIP	Hulsin	HDR0608-302M
1	Q1	ISU04N65A	N-Channel Mosfet 650V;4A	TO-252	IPS	ISU04N65A
1	Q2	3DD13001	Mosfet;400V;0.2A	TO-92	JIANGSU CHANGJIANG	3DD13001
1	Q3	NS				
1	R1	6.8Ω	Film Resistor;1%	0805	Yageo	RC0805FR-076R8L
1	R2	51Ω/1W	Resistor;1%;1W	DIP	any	51Ω /1W
2	R3, R5	1MΩ/0.25W	Resistor;1%;1/4W	DIP	any	1MΩ /1W
1	R4	4.02kΩ	Film Resistor;1%	0603	Yageo	RC0603FR-074K02L
1	R6	30Ω	Film Resistor;1%	0805	Yageo	RC0805FR-0730RL
1	R7	2Ω	Film Resistor;1%	0805	Yageo	RC0805FR-072RL
1	R8	249kΩ	Film Resistor;1%	0603	Yageo	RC0603FR-07249KL
1	R9	68.1kΩ	Film Resistor;1%	0603	Yageo	RC0603FR-0768K1L
1	R10	100kΩ	Film Resistor;1%	1206	Yageo	RM12JTJN104
2	R11, R16	20Ω	Film Resistor;1%	1206	Yageo	RC1206FR-0720RL

EV4060-K-00A BILL OF MATERIALS (continued)

Qty	Ref	Value	Description	Package	Manufacturer	Manufacturer_P/N
1	R12	6.8kΩ/1W	Resistor;1%;1W	DIP	any	6.8kΩ/1W
1	R13	510Ω/1W	Resistor;1%;1W	DIP	any	510Ω/1W
1	R14	2kΩ	Film Resistor;1%	0603	Yageo	RC0603FR-072KL
1	R15	11.3kΩ	Film Resistor;1%	0603	Yageo	RC0603FR-0711K3L
1	R17	0Ω	Film Resistor;1%	1206	Yageo	RC1206FR-070RL
1	R18	NS				
1	FR1	39Ω/1W	Fuse Resistor;5%	DIP	Yageo	FKN1WSJT-52-39R
1	RV1	TVR07431	MOV	DIP	any	TVR07431
1	T1	EE13	L=1.56mH, Np:Naux=182:54	DIP	Emei	
1	U1	MP4060	TRAIC Dimmable, Offline LED Lighting Controller	MSOP10	MPS	MP4060GK
4	L,N,LED+, LED-	1.0 公针				1.0 公针

TRANSFORMER SPECIFICATION

Electrical Diagram

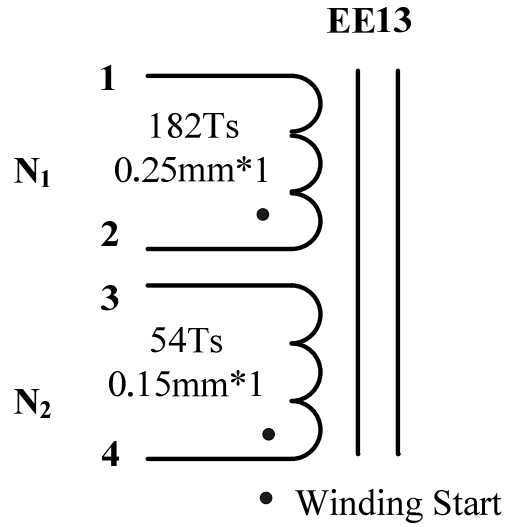

Figure 4—Transformer Electrical Diagram

Winding Diagram

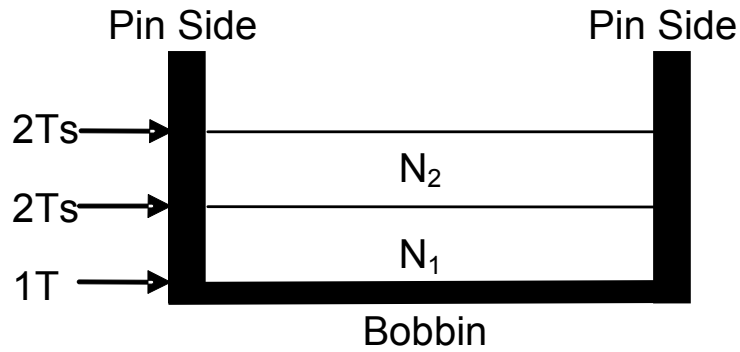

Figure 5—Winding Diagram

Winding Order

Winding No.	Tape Layer Number	Start & End	Magnet Wire Φ (mm)	Turns
	1			
N ₁	2	2→1	0.25mm * 1	182
N ₂	2	4→3	0.15mm*1	54

Electrical Specifications

Electrical Strength	60 second, 60Hz, from Windings to CORE.	1000VAC
Inductance	Pins 2 - 1, all other windings open, measured at 60kHz, 0.1 VRMS	1.56mH±8%

Materials

Item	Description
1	Core: EE13, UI=2500±25%, ACME P4 or equivalent
2	Bobbin: EE13, 5+5PIN, REMOVE PIN5,6,8,9,10
3	Wire: Φ 0.25mm, Φ 0.15mm, 2UEW, CLASS F or equivalent
4	Tape: 6.5mm(W)×0.06mm(TH)
5	Varnish: JOHN C. DOLPH CO, BC-346A or equivalent
6	Solder Bar: CHEN NAN: SN99.5/Cu0.5 or equivalent

EVB TEST RESULTS

Performance Data

Efficiency, PF and THD

<i>f</i> (Hz)	V _{in} (V)	P _{in} (W)	V _o (V)	I _o (mA)	P _o (W)	Efficiency(%)	PF	THD(%)
50	198	10.74	74.20	124.9	9.267	86.29	0.891	24.0
	210	10.78	74.20	125.3	9.297	86.25	0.876	25.4
	220	10.82	74.20	125.6	9.319	86.13	0.859	26.8
	230	10.88	74.20	125.9	9.341	85.86	0.843	28.4
	240	10.92	74.20	126.2	9.364	85.75	0.826	30.1
	250	10.96	74.20	126.5	9.386	85.64	0.811	32.5
	265	11.05	74.20	127.0	9.423	85.28	0.789	35.4

Dimming Compatibility (No flicker and shimmer with these 17 different Dimmers)

Dimmer No.	Manufacturer	Part No.	Power Stage	Dimming Type	I _{max} (mA)	I _{min} (mA)
1	MIKA	433/4	60-400W	Leading	126	28
2	Busch	2250U	600W	Leading	126	13
3	Berker	283010	60-400W	Leading	126	17
4	JUNG	225 NV DE	20-500W/VA	Leading	126	10
5	Berker	286610	20-500W	Leading	126	16
6	LICHTREGLER	T46s	20~315W	Trailing	127	18
7	EMC	PROP400U	40-400W	Leading	126	14
8	Busch	2247U	500W/VA	Leading	126	18
9	Busch	2200	60-400W	Leading	126	22
10	Busch	6513 U-102	420W/VA	Trailing	127	11
11	JUNG	225 NV DE	20...500W/VA	Leading	126	17
12	MIKA	433 HAB	20-315W	Trailing	127	14
13	MIKA?	EIM-585	20-300W	Trailing	127	1
14	Busch	6519U	550W/VA	Trailing	127	10
15	JUNG	225 TDE	20...525W	Trailing	127	12
16	SIEMENS	5TC8 284	20-600W	Trailing	127	10
17	JUNG	266 GDE	60...600W	Leading	126	15

Electric Strength Test

Input and output was shorted respectively. 3750VAC/50Hz sine wave applied between input and output for 1min, and operation was verified.

Surge Test

Line to Line 500V surge testing was completed according to IEC61547.

Input voltage was set at 230VAC/50Hz. Output was loaded at full load and operation was verified following each surge event.

Surge Level (V)	Input Voltage (VAC)	Injection Location	Injection Phase (°)	Test Result (Pass/Fail)
500	230	L to N	90	Pass
-500	230	L to N	270	Pass

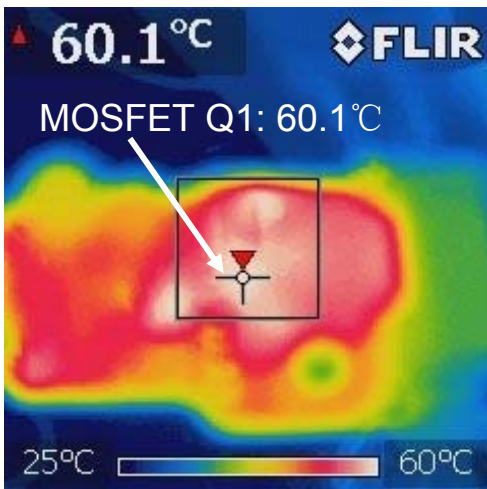
Thermal Test

Without dimmer

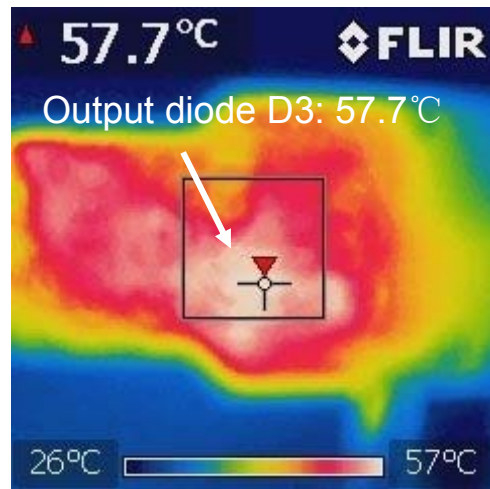

Without dimmer

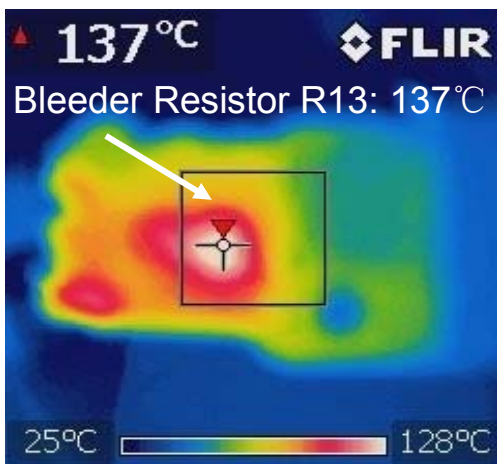

Leading edge dimmer with 50% turn on phase

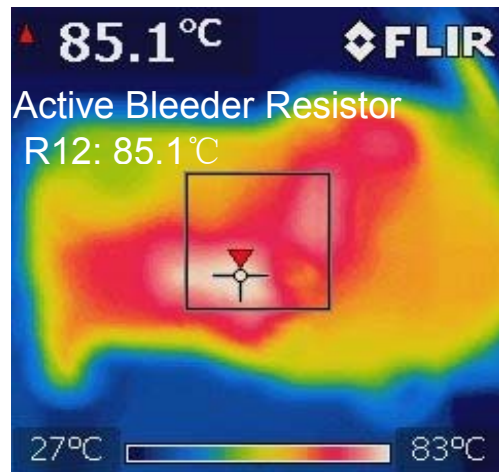

Trailing edge dimmer with 90% turn on phase

EVB TEST RESULTS

Performance waveforms are tested on the evaluation board.
 $V_{IN}=230V_{AC}/50Hz$, 24 LEDs in series, $I_{LED}=125mA$, $V_{OUT}=72V$.

Line Regulation

$V_{IN}=(198-265)V_{AC}/50Hz$, Full Load

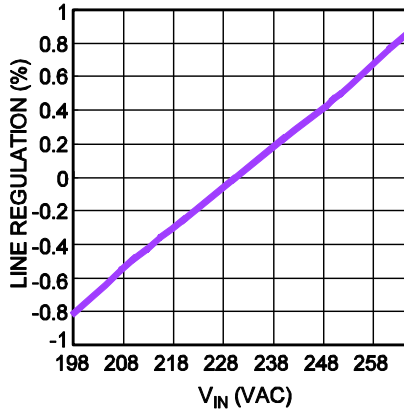

Efficiency vs. V_{IN}

$V_{IN}=(198-265)V_{AC}/50Hz$, Full Load

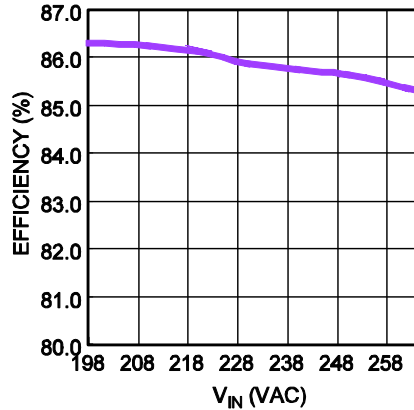

PF vs. V_{IN}

$V_{IN}=(198-265)V_{AC}/50Hz$, Full Load

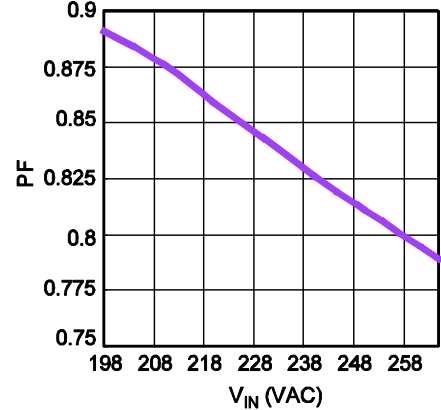

THD vs. V_{IN}

$V_{IN}=(198-265)V_{AC}/50Hz$, Full Load

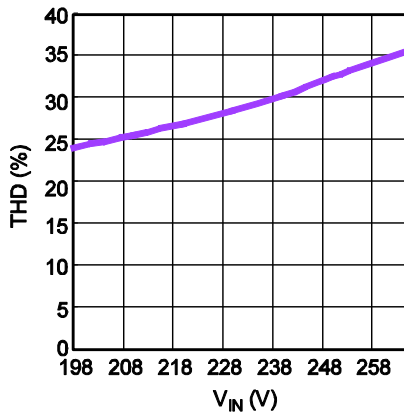

Dimming Curve

$V_{IN}=230V_{AC}/50Hz$, Full Load,
with Different Dimmers

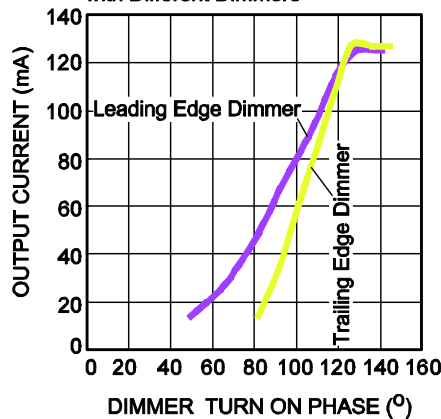

Conducted EMI, L-Line

$V_{IN}=230V_{AC}/50Hz$,
RBW=9kHz, MT=20ms

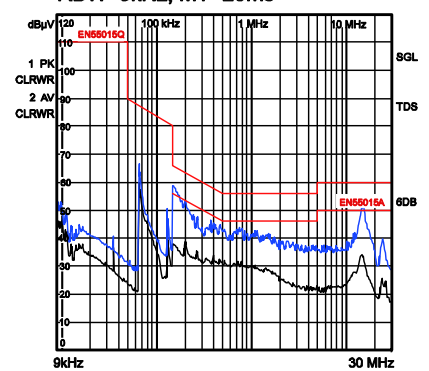

Conducted EMI, N-Line

$V_{IN}=230V_{AC}/50Hz$,
RBW=9kHz, MT=20ms

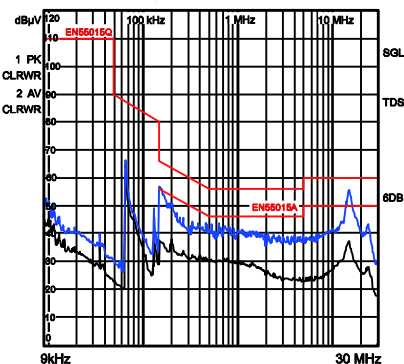

CDN Test

$V_{IN}=230V_{AC}/50Hz$,
RBW=120kHz, MT=1ms

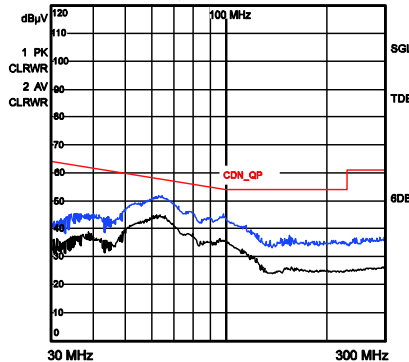

EVB TEST RESULTS (continued)

Performance waveforms are tested on the evaluation board.

 $V_{IN}=230V_{AC}/50Hz$, 24 LEDs in series, $I_{LED}=125mA$, $V_{OUT}=72V$.

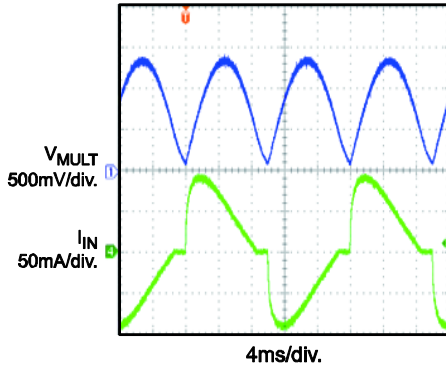
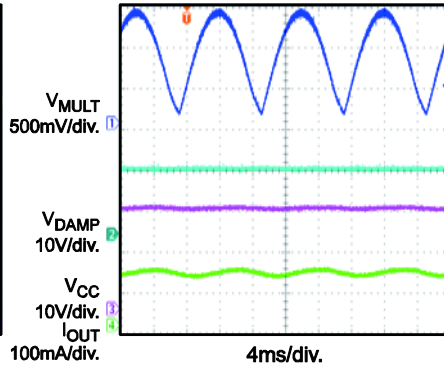
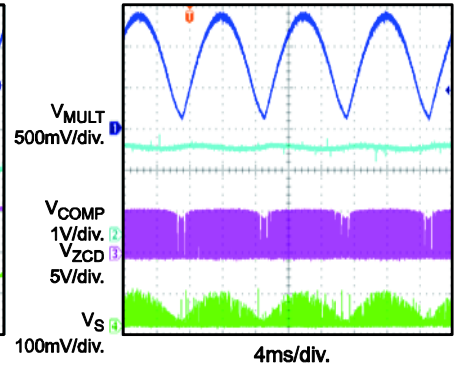
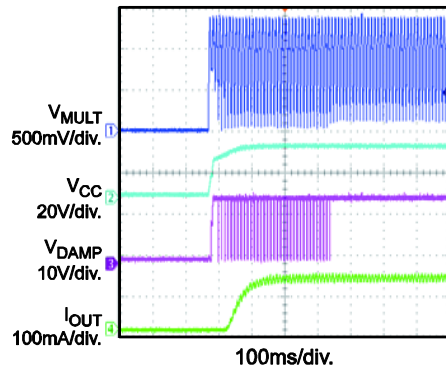
Steady State
 $V_{IN}=230V_{AC}/50Hz$, Full Load

Steady State
 $V_{IN}=230V_{AC}/50Hz$, Full Load

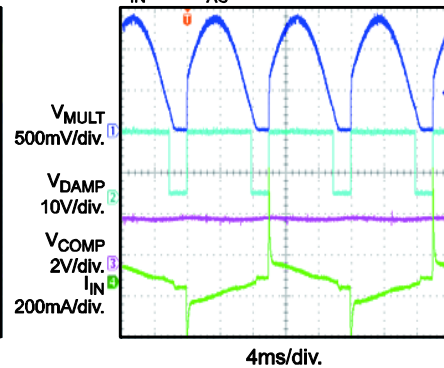
Steady State
 $V_{IN}=230V_{AC}/50Hz$, Full Load

 V_{IN} Start-Up
 $V_{IN}=230V_{AC}/50Hz$, Full Load

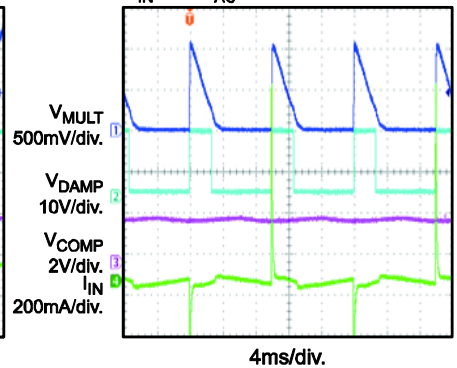
Dimming Performance

Max Dmming on Phase with Leading-Edge Dimmer

 $V_{IN}=230V_{AC}/50Hz$

Dimming Performance

Min Dmming on Phase with Leading-Edge Dimmer

 $V_{IN}=230V_{AC}/50Hz$

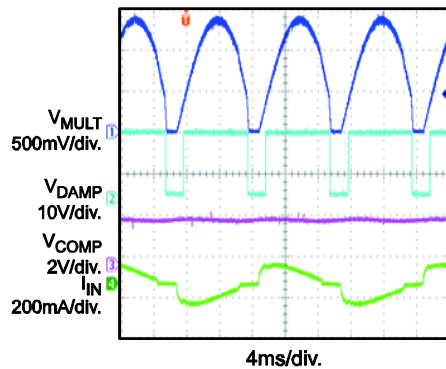
Dimming Performance

Max Dmming on Phase with Trailing-Edge Dimmer

 $V_{IN}=230V_{AC}/50Hz$

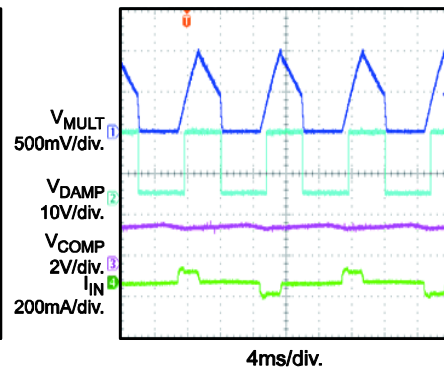
Dimming Performance

Min Dmming on Phase with Trailing-Edge Dimmer

 $V_{IN}=230V_{AC}/50Hz$

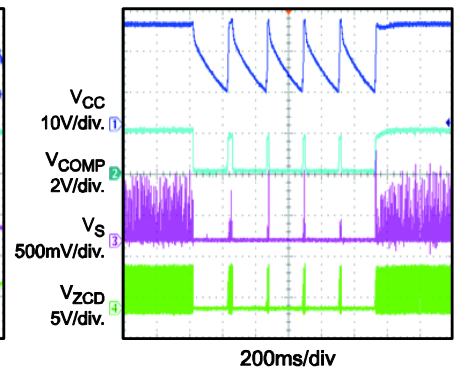
OVP

LED Load Open then Recovery

 $V_{IN}=230V_{AC}/50Hz$, Full Load

EVB TEST RESULTS *(continued)*

Performance waveforms are tested on the evaluation board.

$V_{IN}=230V_{AC}/50Hz$, 24 LEDs in series, $I_{LED}=125mA$, $V_{OUT}=72V$.

SCP

LED+ Short to LED- and then Recovery

$V_{IN}=230V_{AC}/50Hz$, Full Load

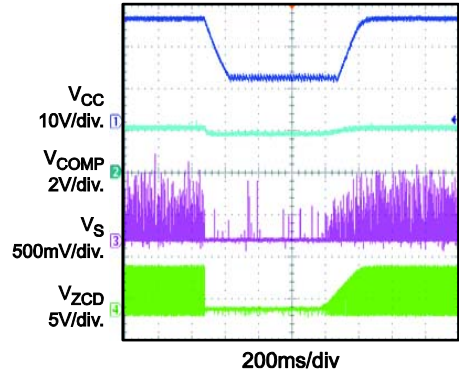

QUICK START GUIDE

1. Preset AC Power Supply to $198\text{VAC} \leq V_{\text{IN}} \leq 265\text{VAC}$.
2. Turn Power Supply off.
3. Connect the LED string between “LED+” (anode of LED string) and “LED-” (cathode of LED string).
4. Connect Power Supply terminals to AC V_{IN} terminals (“L” and “N”) as shown on the board.
5. Turn AC Power Supply on after making connections.

NOTICE: The information in this document is subject to change without notice. Users should warrant and guarantee that third party Intellectual Property rights are not infringed upon when integrating MPS products into any application. MPS will not assume any legal responsibility for any said applications.