

DESCRIPTION

The EV4569-N-00A is an evaluation board for the MP/MQ4569GN, a step-down switching regulator with integrated high-side/low-side, high-voltage power MOSFETs. It provides a highly efficient output of up to 0.3A.

The wide 4.5V to 75V input range accommodates a variety of step-down applications in automotive environment. A 5µA shutdown mode quiescent current in full temperature range is good for battery-powered applications.

It allows for high power conversion efficiency over a wide load range by scaling down the switching frequency under light-load condition to reduce the switching and gate driver losses.

The EV4569-N-00A is assembled and tested with SOIC-8 EP package.

ELECTRICAL SPECIFICATIONS

Parameter	Symbol	Value	Units
Input Voltage	V_{IN}	4.5-75	V
Output Voltage	V_{OUT}	3.3	V
Output Current	I_{OUT}	0.3	A

FEATURES

- 20µA Quiescent Current (Active mode)
- Wide 4.5V to 75V Operating Input Range
- Programmable Soft-Start
- FB-Tolerance: 1% at Room Temperature; 2% at Full Temperature.
- Adjustable Output
- Low Shutdown Mode Current: 5µA
- Available in AEC-Q100 Grade 1
- Fully Assembled and Tested

APPLICATIONS

- Automotive Systems
- Industrial Power Systems
- Distributed Power Systems
- Battery Powered Systems

All MPS parts are lead-free and adhere to the RoHS directive. For MPS green status, please visit MPS website under Products, Quality Assurance page.

"MPS" and "The Future of Analog IC Technology" are registered trademarks of Monolithic Power Systems, Inc.

EV4569-N-00A EVALUATION BOARD



(L x W x H) 2.5" x 2.5" x 0.2"
(6.4cm x 6.4cm x 0.5cm)

Board Number	MPS IC Number
EV4569-N-00A	MPQ4569GN

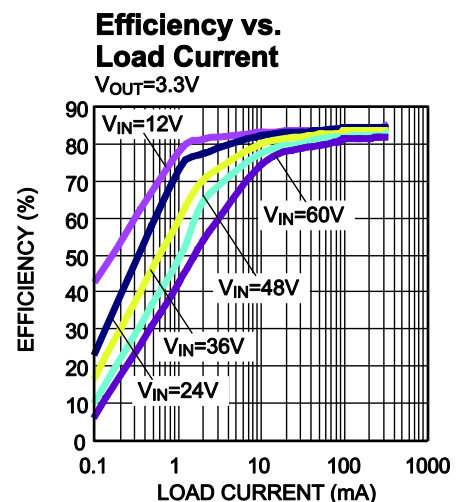

EVALUATION BOARD SCHEMATIC

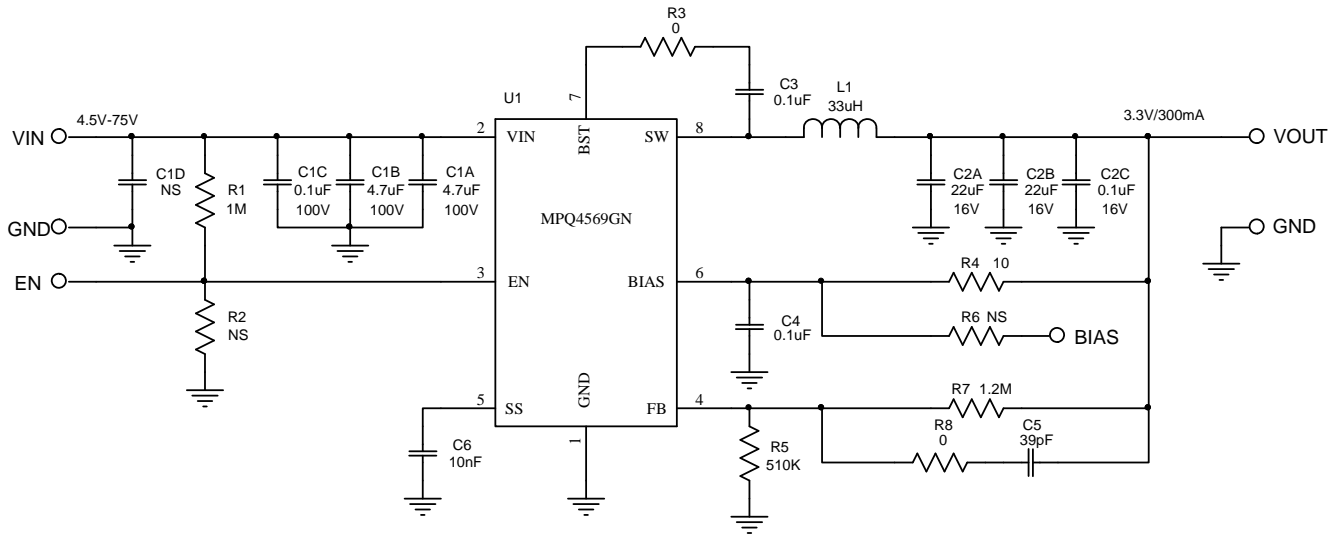

EV4569-N-00A BILL OF MATERIALS

Qty.	Designator	Value	Description	Package	Manufacture	Manufacture_PN
2	C1A, C1B	4.7uF	Ceramic Capacitor; 100V;X7S;1210	1210	TDK	C3225X7S2A475K
1	C1C	0.1uF	Ceramic Capacitor; 100V;X7R;0603;	0603	muRata	GRM188R72A104KA35D
2	C2C, C2B	22uF	Ceramic Capacitor; 16V;X7R;1210	1210	muRata	GRM32ER71C226KE18L
3	C3, C4, C2C	0.1uF	Ceramic Capacitor; 16V;X7R;0603	0603	muRata	GRM188R71C104KA01D
1	C5	39pF	Ceramic Capacitor; 50V;C0G;0603	0603	muRata	GRM1885C1H390JA01
1	C6	10nF	Ceramic Capacitor; 50V;X7R;0603;	0603	muRata	GRM188R71H103KA01D
1	C1D	NS				
1	L1	33uH	Inductor;33uH; 110mΩ;1.55A	SMD	TDK	CLF7045T-330M-H
			Inductor;33uH; 163mΩ;1.2A	SMD	ABC	DM5028330ML
1	R1	1M	Film Resistor;1%;	0603	Yageo	RC0603FR-071ML
2	R3, R8	0	Film Resistor;5%;	0603	Yageo	RC0603JR-070RL
1	R4	10	Film Resistor;5%;	0603	Yageo	RC0603JR-0710RL
1	R5	510K	Film Resistor;1%;	0603	Yageo	RC0603FR-07510KL
1	R7	1.2M	Film Resistor;1%	0603	Yageo	RC0603FR-071M2L
2	R2, R6	NS				
1	U1		Step-Down Converter	SOIC-8 EP	MPS	MPQ4569GN

EVB TEST RESULTS

$V_{IN} = 12V$, $V_{OUT} = 3.3V$, $L = 33\mu H$, $C_{OUT} = 2 \times 22\mu F$, $T_A = +25^\circ C$, unless otherwise noted.

Efficiency vs. Load Current

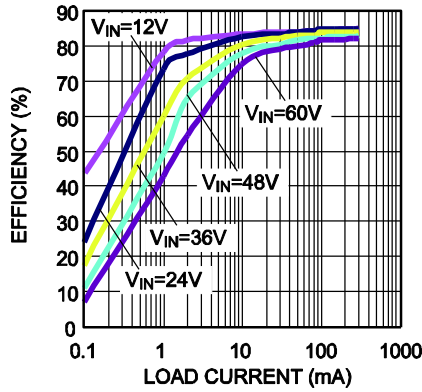

Load Regulation

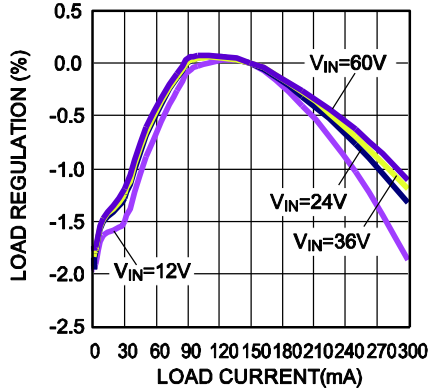

Line Regulation

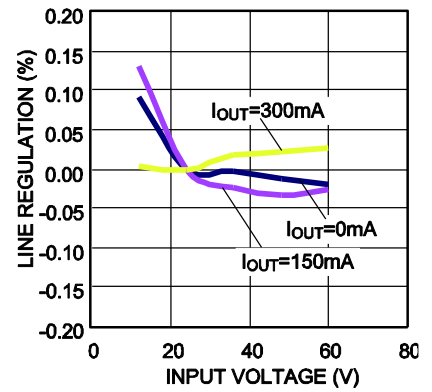

Steady State IOUT=0A

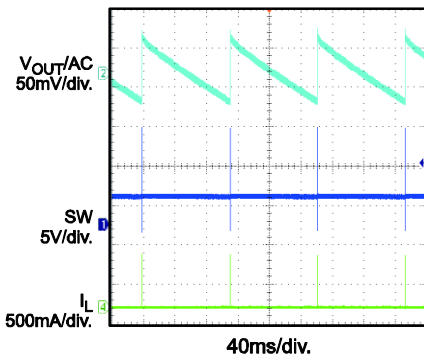

Steady State IOUT=0.3A

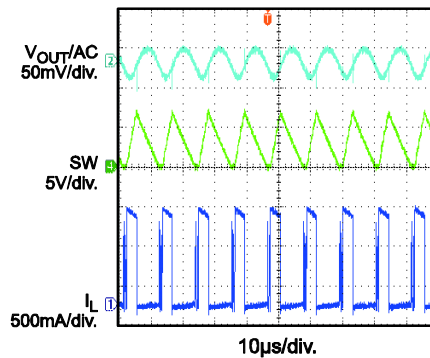

Startup Through VIN IOUT=0A

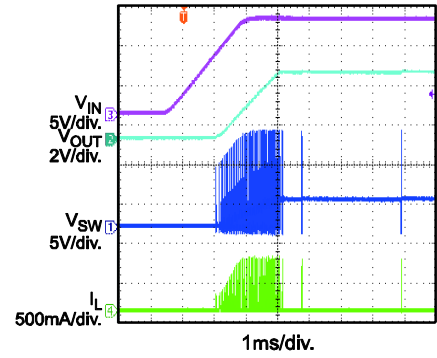

Startup Through VIN IOUT=0.3A

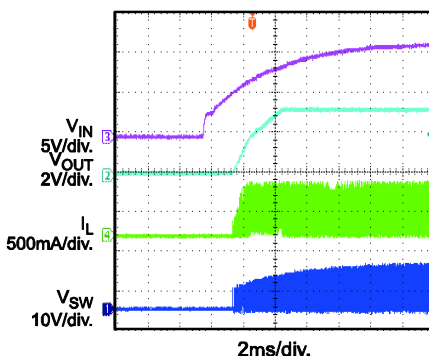

Shutdown Through VIN IOUT=0A

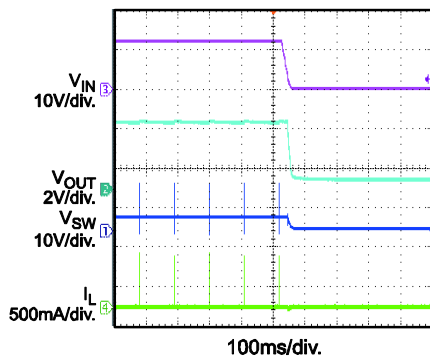

Shutdown Through VIN IOUT=0.3A

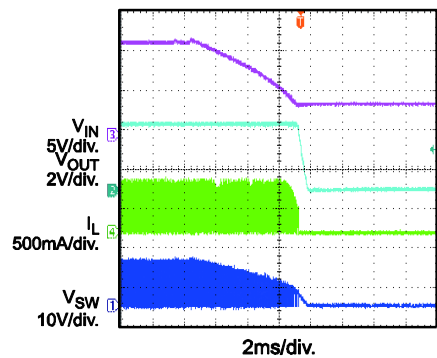

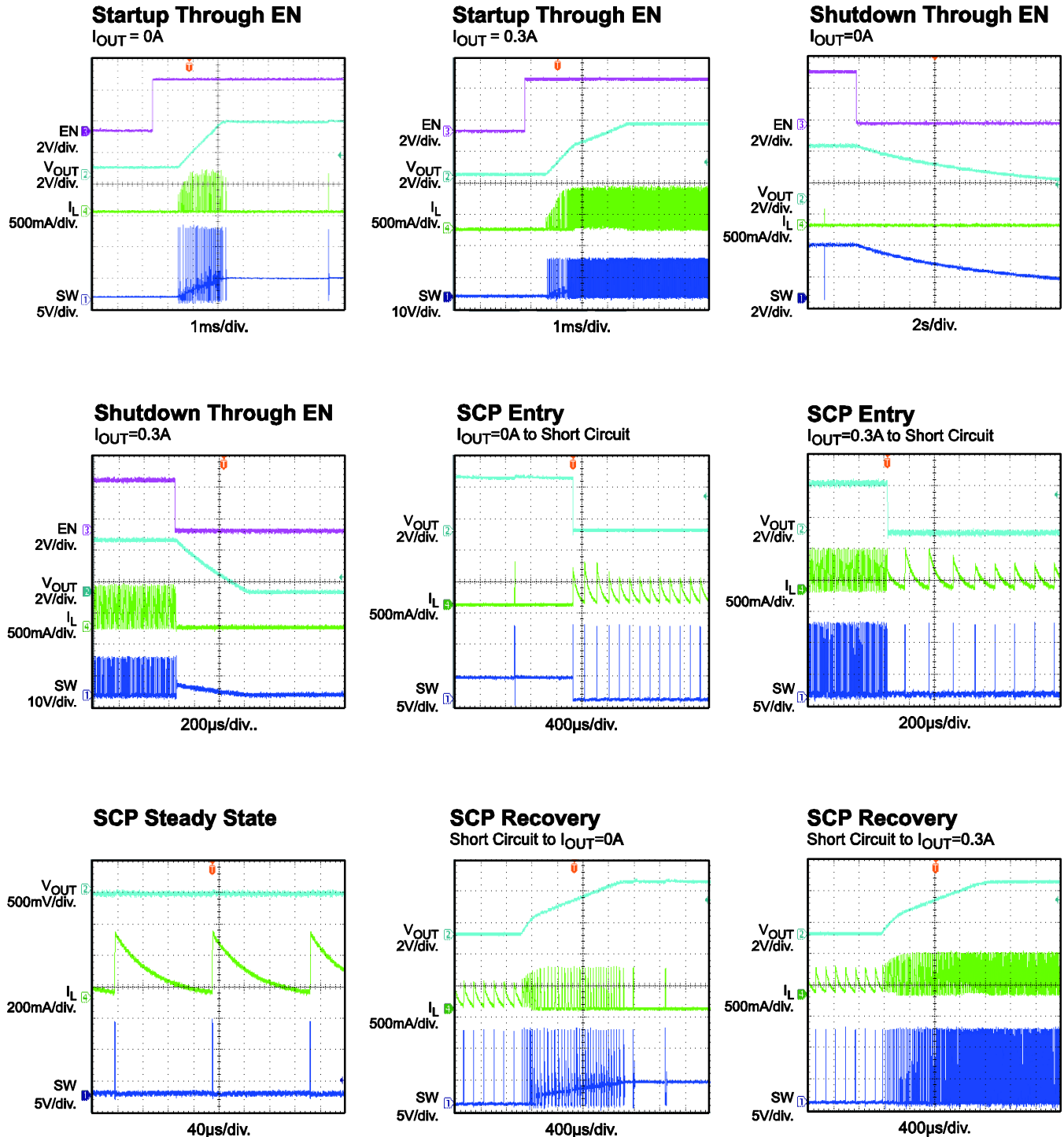
EVB TEST RESULTS *(continued)*
 $V_{IN} = 12V$, $V_{OUT} = 3.3V$, $L = 33\mu H$, $C_{OUT} = 2 \times 22\mu F$, $T_A = +25^\circ C$, unless otherwise noted.

PRINTED CIRCUIT LAYOUT

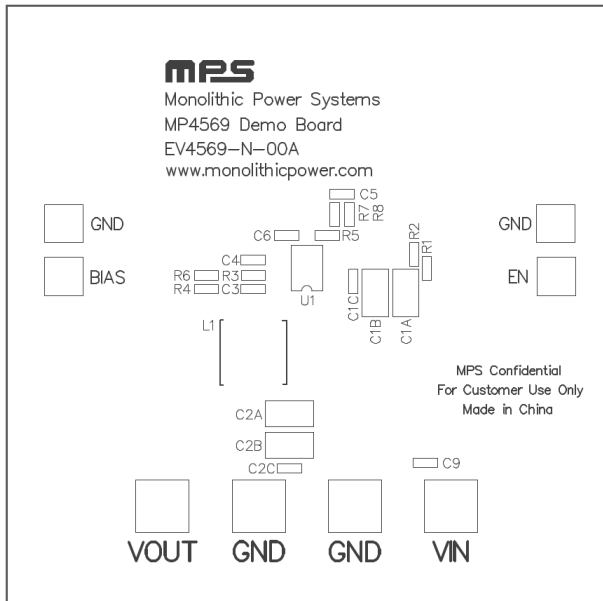

Figure 1 – Top Silk Layer

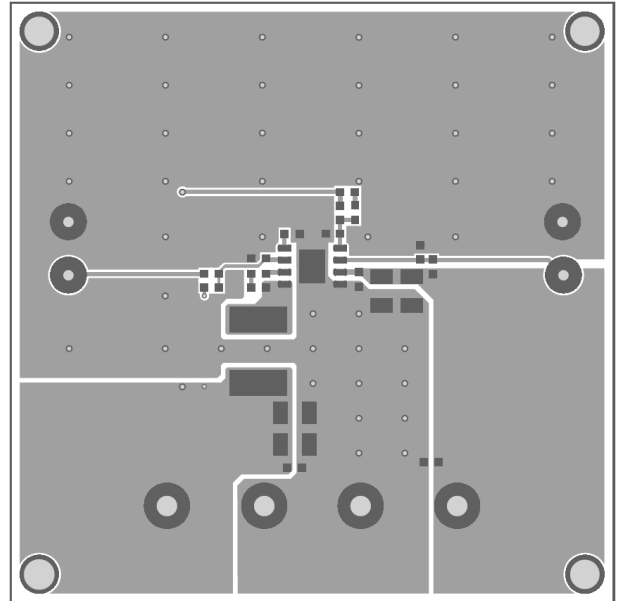

Figure 2 – Top Layer

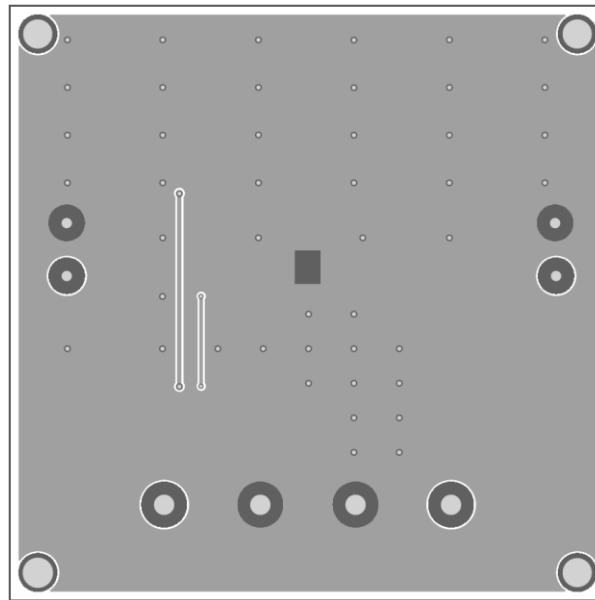

Figure 3 – Bottom Layer

QUICK START GUIDE

1. Connect the positive and negative terminals of the load to the VOUT and GND pins respectively.
2. Preset the power supply output to between 4.5V to 75V and then turn it off.
3. Connect the positive and negative terminals of the power supply output to the VIN and GND pins respectively.
4. Turn the power supply on. The MPQ4569GN will automatically startup.
5. To use the Enable function, apply a digital input to the EN pin. Drive EN higher than 1.55V to turn on the regulator, drive EN less than 1.2V to turn it off. Float this pin to shut the chip down.
6. Internally a zener diode is connected from EN pin to GND pin. The typical clamping voltage of the zener diode is 6.5V. So VIN can be connected to EN through a high ohm resistor if the system doesn't have any other logic input acting as enable signal. The resistor needs to be designed to limit the EN pin sink current less than 150 μ A. Just note that there is an internal 3M resistor from EN to GND, so the external pull up resistor should be smaller than $\frac{[V_{IN(MIN)} - 1.55V] \times 3M}{1.55V}$ to make sure the part can EN on at the lowest operation VIN.
7. Use R7 and R5 to set the output voltage with $V_{FB}=1V$. For $R7=1.2M\Omega$, R5 can be determined by:

$$R5 = \frac{1.2}{V_{OUT} - 1} M\Omega$$

Follow the Application Information section in the device datasheet to recalculate the inductor and output capacitor values when output voltage is changed.

NOTICE: The information in this document is subject to change without notice. Please contact MPS for current specifications. Users should warrant and guarantee that third party Intellectual Property rights are not infringed upon when integrating MPS products into any application. MPS will not assume any legal responsibility for any said applications.