



The Future of Analog IC Technology®

# EV4570-F-00A

## 3A, 55V, Frequency programmable Step-Down Converter

### DESCRIPTION

The EV4570-F-00A is an evaluation board for the MP4570/MPQ4570, a frequency programmable step-down switching converter with integrated internal high-side and low side power MOSFETs. It can provide 3A continuous output current with peak current control for excellent transient response and efficiency performance.

The wide 4.5V to 55V input voltage range accommodates a variety of step down applications, including those applications in industrial, PoE, automotive and printer with DC high voltage bus.

The valley current detection is used to avoid current running way at over current protection. Also it has accurate and reliable over voltage protection, and auto recovery thermal protection. In addition, the optional external soft start is available. Enable and power good indication function can be used to power track easily. In order to increase the efficiency, MP4570/MPQ4570 will automatically scaling down the switching frequency when load is light. Meanwhile, the low side MOSFET will be turned off to reduce driver loss when zero inductor current is detected. Synchronous operation mode with integrated low side MOSFET is much helpful to reduce the conduction loss and also beneficial to reduce external components space and save the cost.

The MP4570/MPQ4570 is available in a TSSOP-20 EP with exposed pad package.

### ELECTRICAL SPECIFICATIONS

| Parameter      | Symbol    | Value  | Units |
|----------------|-----------|--------|-------|
| Input Voltage  | $V_{IN}$  | 4.5-55 | V     |
| Output Voltage | $V_{OUT}$ | 3.3    | V     |
| Output Current | $I_{OUT}$ | 3      | A     |

### FEATURES

- Wide Input Voltage Range: 4.5V to 55V
- Programmable Switching Frequency
- Stable Independent on Output Capacitors
- Optional External Soft Start
- Peak Current Mode Control
- OCP Protection with Valley Current Detection
- Support External SYNC Clock
- OVP Protection
- Current Limit Decreasing during Output Short for Better Thermal Performance
- Power Good Indication
- Thermal Shutdown Protection
- Fully Assembled and Tested

### APPLICATIONS

- PoE Input Non-isolated Buck
- Industrial Power Systems
- Printers and Scanners
- Automotive Power Systems
- Distributed Power Systems

All MPS parts are lead-free and adhere to the RoHS directive. For MPS green status, please visit MPS website under Quality Assurance. "MPS" and "The Future of Analog IC Technology" are Registered Trademarks of Monolithic Power Systems, Inc.

### EV4570-F-00A EVALUATION BOARD



(L x W x H) 2.5" x 2.5" x 0.2"  
(6.4cm x 6.4cm x 0.5cm)

| Board Number | MPS IC Number |
|--------------|---------------|
| EV4570-F-00A | MPQ4570GF     |

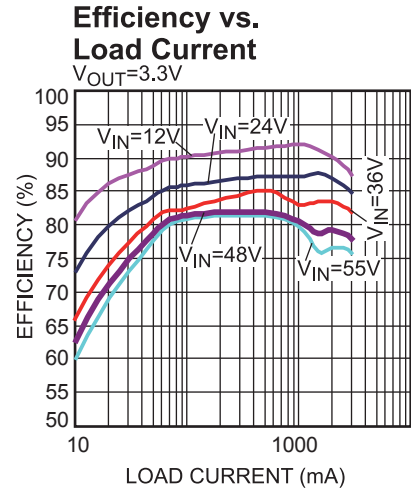

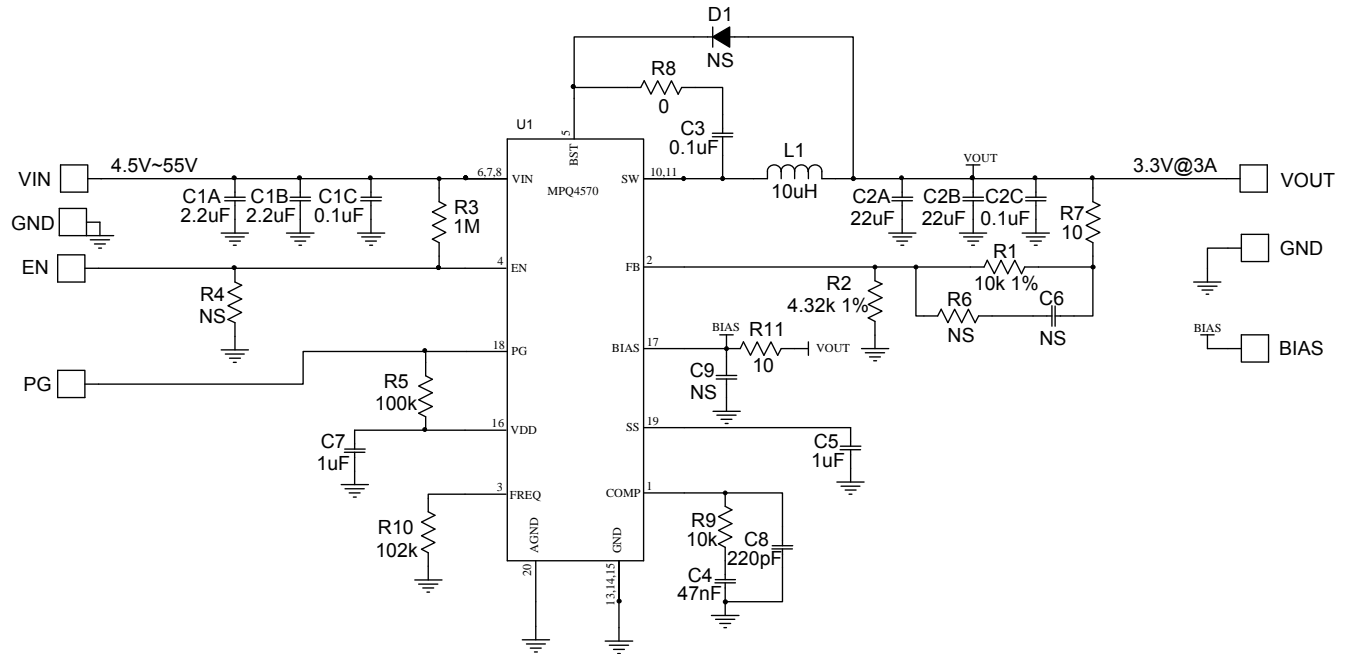
**EVALUATION BOARD SCHEMATIC**

**EV4570-F-00A BILL OF MATERIALS**

| Qty | Ref          | Value       | Description                    | Package | Manufacture | Part Number        |
|-----|--------------|-------------|--------------------------------|---------|-------------|--------------------|
| 2   | C1A, C1B     | 2.2 $\mu$ F | Ceramic Capacitor;<br>100V;X7R | 1210    | muRata      | GRM32ER72A225KA35L |
| 1   | C1C          | 0.1 $\mu$ F | Ceramic Capacitor;<br>100V;X7R | 0603    | muRata      | GRM188R72A104KA35D |
| 2   | C2A,C2B      | 22 $\mu$ F  | Ceramic Capacitor;<br>16V;X7R  | 1210    | muRata      | GRM32ER71C226KE18L |
| 2   | C2C,C3       | 0.1 $\mu$ F | Ceramic Capacitor;<br>16V;X7R  | 0603    | muRata      | GRM188R71C104KA01D |
| 1   | C4           | 47nF        | Ceramic Capacitor;<br>50V;X7R  | 0603    | muRata      | GRM188R71H473KA61D |
| 2   | C5,C7        | 1 $\mu$ F   | Ceramic Capacitor;<br>16V;X7R  | 0603    | muRata      | GRM188R71C105KA12D |
| 1   | C8           | 220pF       | Ceramic Capacitor;<br>50V;C0G  | 0603    | muRata      | GRM1885C1H221JA01D |
| 2   | C6,C9        | NS          |                                |         |             |                    |
| 2   | R1,R9        | 10k         | Film Resistor;1%;              | 0603    | Yageo       | RC0603FR-0710KL    |
| 1   | R2           | 4.32k       | Film Resistor;1%;              | 0603    | Yageo       | RC0603FR-074K32L   |
| 1   | R3           | 1M          | Film Resistor;5%;              | 0603    | Yageo       | RC0603JR-071ML     |
| 2   | R4,R6,<br>D1 | NS          |                                |         |             |                    |
| 1   | R5           | 100k        | Film Resistor;1%;              | 0603    | Yageo       | RC0603FR-07100KL   |
| 2   | R7,R11       | 10          | Film Resistor;1%;              | 0603    | Yageo       | RC0603FR-0710RL    |

**EV4570-F-00A BILL OF MATERIALS (continued)**

| Qty. | Ref                          | Value      | Description                    | Package    | Manufacture | Part Number      |
|------|------------------------------|------------|--------------------------------|------------|-------------|------------------|
| 1    | R8                           | 0          | Film Resistor;5%;              | 0603       | Yageo       | RC0603JR-070RL   |
| 1    | R10                          | 102k       | Film Resistor;1%;              | 0603       | Yageo       | RC0603FR-07102KL |
| 1    | L1                           | 10 $\mu$ H | Inductor;5.8A;<br>25.4mohm DCR | SMD        | ABC         | CU1048100YEB     |
|      |                              |            | Inductor;5.2A;<br>30mohm DCR   | SMD        | Wurth       | 74437368100      |
| 1    | U1                           |            | Step-Down<br>Converter         | TSSOP20-EP | MPS         | MPQ4570GF        |
| 4    | VIN,<br>GND,<br>GND,<br>VOUT |            | 2.0 Golden Pin                 |            | HZ          |                  |
| 11   | PG,GND,<br>EN,GND,<br>BIAS   |            | 2.0mm Test Pin                 |            | Any         |                  |

## EVB TEST RESULTS

$V_{IN} = 48V$ ,  $V_{OUT} = 3.3V$ ,  $C_{OUT} = 2 \times 22\mu F$ ,  $L = 10\mu H$ ,  $f_{SW} = 500kHz$ ,  $T_A = +25^\circ C$ , unless otherwise noted.

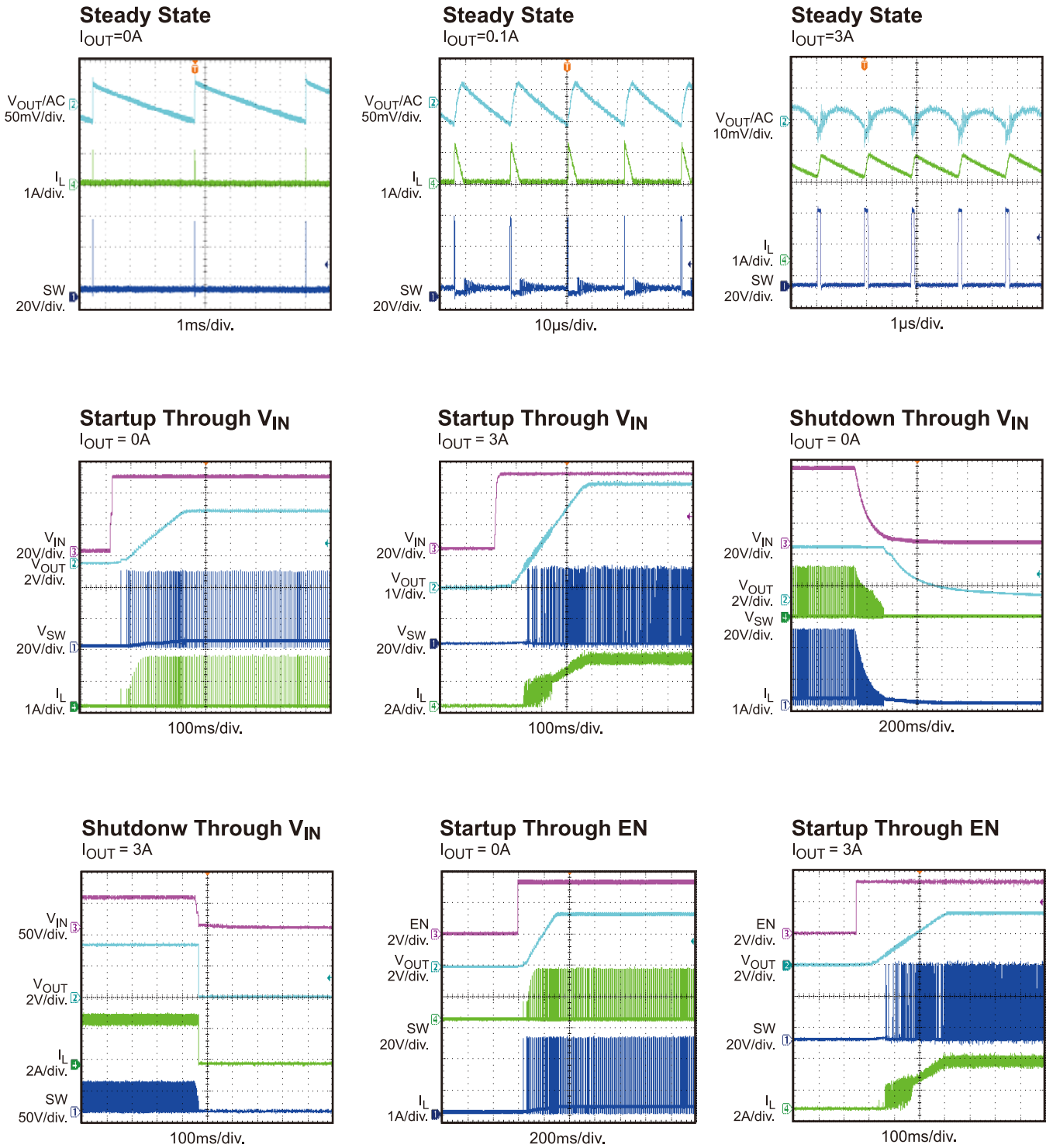

## EVB TEST RESULTS

$V_{IN} = 48V$ ,  $V_{OUT} = 3.3V$ ,  $C_{OUT} = 2 \times 22\mu F$ ,  $L = 10\mu H$ ,  $f_{SW} = 500kHz$ ,  $T_A = +25^\circ C$ , unless otherwise noted.

**Shutdown Through EN**  
 $I_{OUT} = 0A$

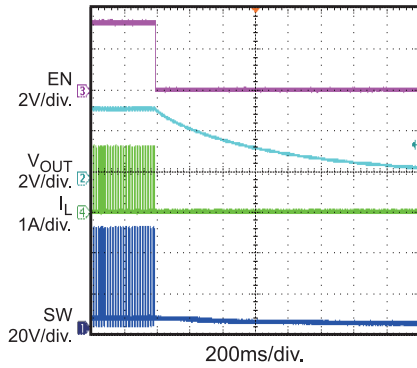

**Shutdown Through EN**  
 $I_{OUT} = 3A$

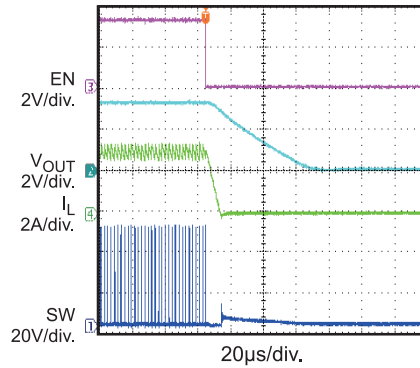

**SCP Entry**  
 $I_{OUT} = 0A$  to Short Circuit

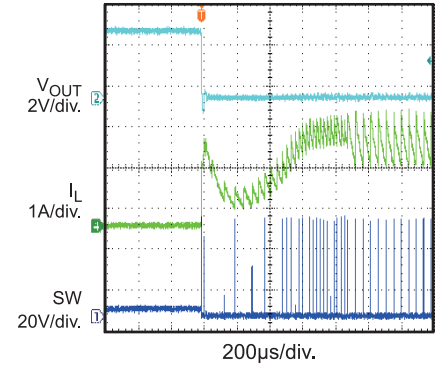

**SCP Entry**  
 $I_{OUT} = 3A$  to Short Circuit

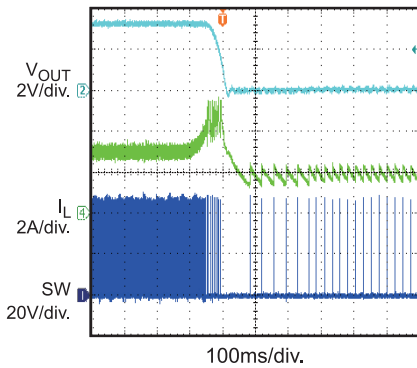

**SCP Steady State**

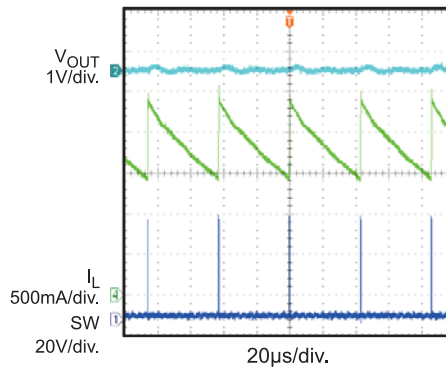

**SCP Recovery**  
Short Circuit to  $I_{OUT} = 0A$

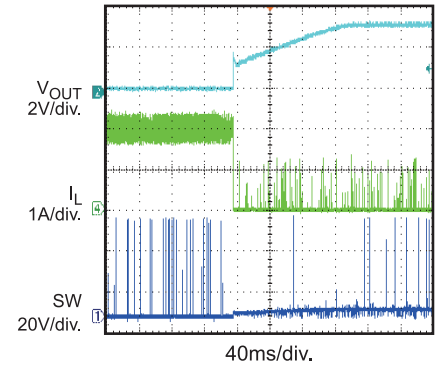

**SCP Recovery**  
Short Circuit to  $I_{OUT} = 3A$

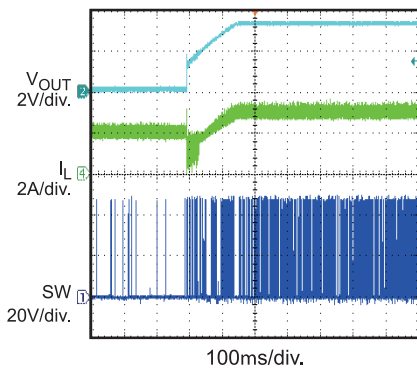

**Load Transient**  
 $I_{OUT} = 1.5A \leftrightarrow 3A$ ,  $1.6A/\mu s$

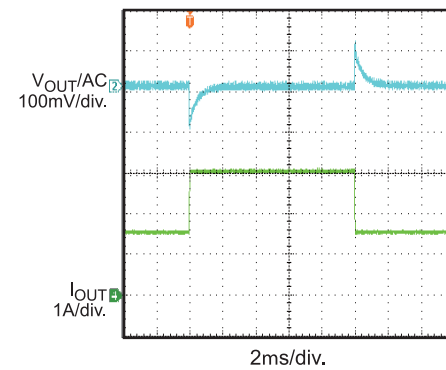

**EVB TEST RESULTS** *(continued)*

$V_{IN} = 48V$ ,  $V_{OUT} = 3.3V$ ,  $C_{OUT} = 2 \times 22\mu F$ ,  $L = 10\mu H$ ,  $f_{SW} = 500kHz$ ,  $T_A = +25^\circ C$ , unless otherwise noted.

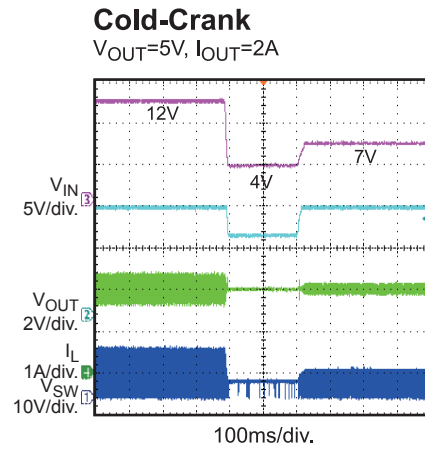
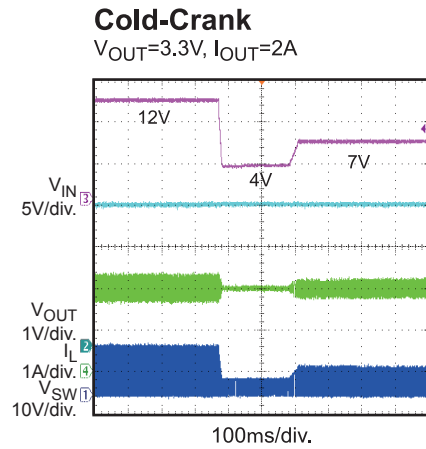

PRINTED CIRCUIT LAYOUT

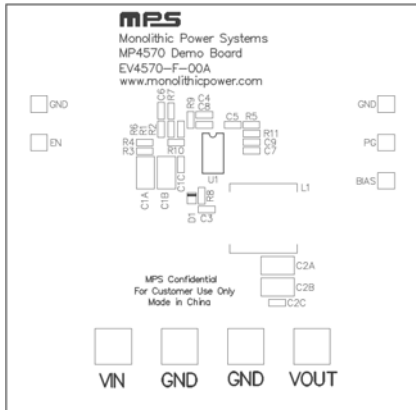

Figure1 – Top Silk Layer

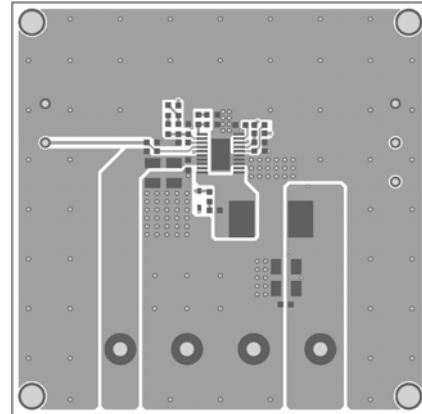

Figure 2 – Top Layer

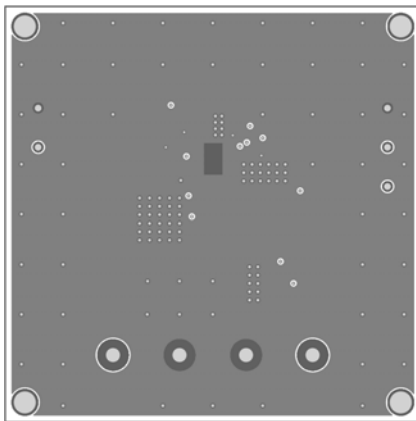

Figure3 – Inner Layer 1

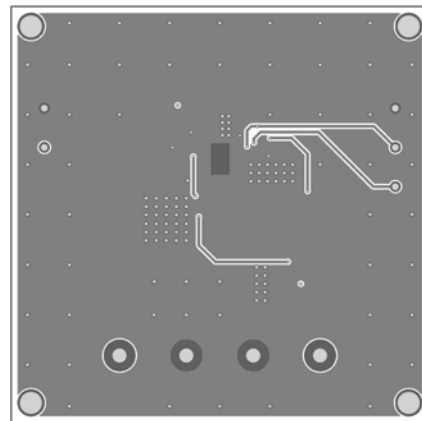

Figure 4 – Inner Layer 2

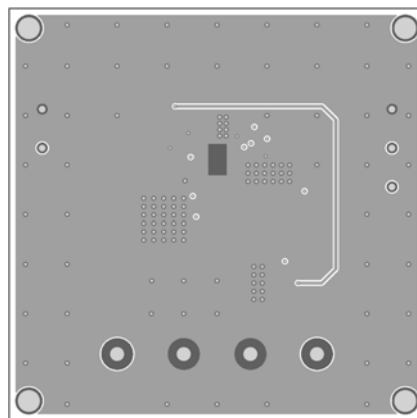

Figure5 – Bottom Layer



## QUICK START GUIDE

1. Connect the positive and negative terminals of the load to the VOUT and GND pins respectively.
2. Preset the power supply output to between 4.5V to 55V, and then turn it off.
3. Connect the positive and negative terminals of the power supply output to the VIN and GND pins respectively.
4. Turn the power supply on. The MP4570/MPQ4570GF will automatically startup.
5. To use the Enable function, apply a digital input to the EN pin. Drive EN higher than 1.6V to turn on the regulator, drive EN less than 1.3V to turn it off. There is no internal pull-up or pull-down circuit, so do not float this pin.
6. Connection the EN pin directly to a voltage source without any pull-up resistors requires limiting voltage amplitude to  $\leq 6V$  to prevent damage to the internal zener diode between EN and GND; EN pin can also be connected to higher voltage (e.g. VIN) through pull-up resistor, but need to make sure the pull-up resistor is high enough to make sure the sink current into EN pin less than  $150\mu A$  to avoid damaging the zener diode. For example, when connecting EN to  $V_{IN}=12V$ ,  $R_{pull-up} \geq (12V - 6.5V) \div 150\mu A = 37k\Omega$ .
7. Use R10 to re-program switching frequency if needed. The recommended  $R_{FREQ}$  values for various  $f_{sw}$  please see Table 1.

**Table 1 —  $f_{sw}$  vs.  $R_{FREQ}$**

| $f_{sw}$ (kHz) | $R_{FREQ}$ (k $\Omega$ ) |
|----------------|--------------------------|
| 1000           | 47.5                     |
| 900            | 56                       |
| 800            | 63.4                     |
| 700            | 73.2                     |
| 600            | 84.5                     |
| 500            | 102                      |
| 400            | 133                      |
| 300            | 178                      |
| 200            | 261                      |
| 100            | 523                      |

8. Use R1 and R2 to set the output voltage with  $V_{FB}=1V$ . For  $R1=10k\Omega$ , R2 can be determined by:

$$R2 = \frac{10}{V_{OUT} - 1} k\Omega$$

Follow the Application Information section in the device datasheet to recalculate the compensation, inductor and output capacitor values when output voltage is changed.

**NOTICE:** The information in this document is subject to change without notice. Users should warrant and guarantee that third party Intellectual Property rights are not infringed upon when integrating MPS products into any application. MPS will not assume any legal responsibility for any said applications.