

DESCRIPTION

The EV5000ADQ-00A is the evaluation board for the MP5000ADQ, a protection device designed to protect circuitry on the output (source) from transients on input (VCC). It also protects VCC from undesired shorts and transients coming from the source.

Besides the input capacitor and output capacitor, EV5000ADQ-00A contains a low power resistor to set the current limit (ILimit) as well as a capacitor for dV/dt functions, which capacitor is optional.

The demo board defaults are for an 8.5 V turn on point and a 15 V over voltage clamp. The current limit is set at 4.7A limit (22Ω).

ELECTRICAL SPECIFICATIONS

Parameter	Symbol	Value	Units
Input Voltage	V _{IN}	8.5-22	V
Output Voltage Clamp	V _{OUT}	15	V
Output Current	I _{OUT}	4.5	A

FEATURES

- Adjustable Slew Rate for Output Voltage
- 4.7A Current Limit
- Integrated Power FET Thermal Protection
- Over Voltage Clamp

APPLICATIONS

- Hot Swap
- PC Cards
- Cell Phones
- Laptops
- Low Inrush Current

All MPS parts are lead-free and adhere to the RoHS directive. For MPS green status, please visit MPS website under Quality Assurance. "MPS" and "The Future of Analog IC Technology" are Registered Trademarks of Monolithic Power Systems, Inc.

EV5000ADQ-00A EVALUATION BOARD



(L x W x H)
(6.35cm x 6.35cm x 0.3cm)

Board Number	MPS IC Number
EV5000ADQ-00A	MP5000ADQ

Trip Current and Hold Current vs. R_{LIMIT}

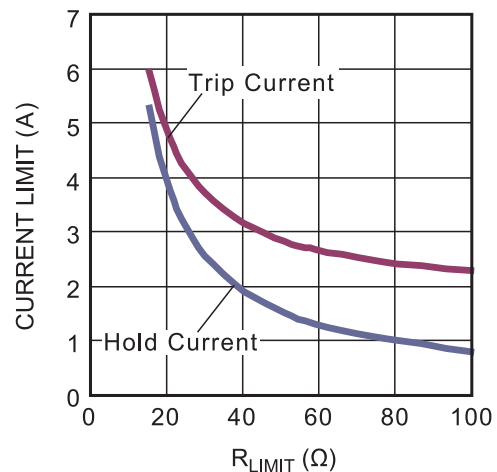

EVALUATION BOARD SCHEMATIC

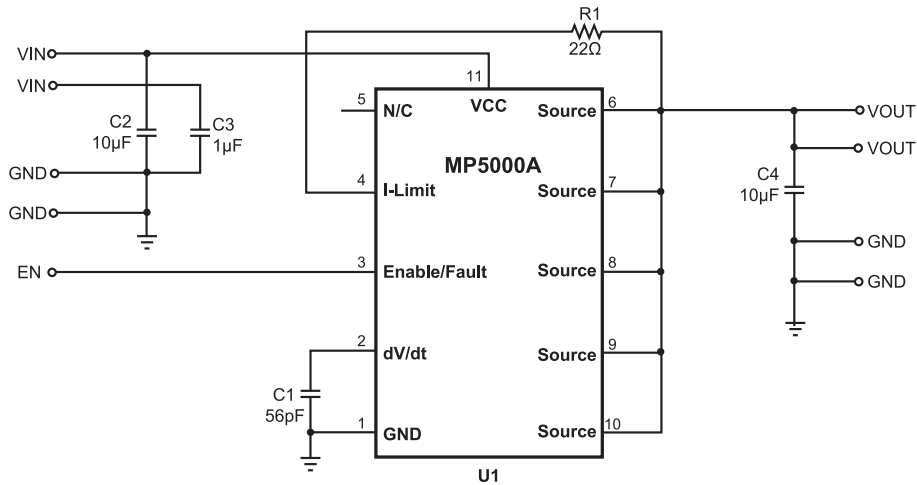

EV5000ADQ-00A BILL OF MATERIALS

Qty	Ref	Value	Description	Package	Manufacturer	Manufacturer P/N
1	C1	56pF	Ceramic Cap, X7R, 50V	0603	Murata	GRM188R71H560KA01D
2	C2,C4	10uF	Ceramic Cap, X5R, 25V	1206	Murata	GRM32DR71E106KA12
					TDK	C3216X5R1E106K
1	C3	1uF	Ceramic Cap, X7R, 16V	0603	Murata	GRM188R71C105KA12D
1	R1	22Ω	Film Res, 1%	0603	Yageo	RC0603FR-0722RL
1	U1		Electronic Fuse	QFN-10	MPS	MP5000ADQ

EVB TEST RESULTS

Performance waveforms are tested on the evaluation board.

$V_{IN} = 12V$, $V_{EN} = 3.3V$, $R_{LIMIT} = 22\Omega$, $C_{OUT} = 10\mu F$, $C_{dv/dt} = 1nF$, $T_A = 25^\circ C$, unless otherwise noted.

Turn On Delay and Rise Time With 1 μF Load

$C_{OUT} = 1\mu F$, No Load, $C_{dv/dt}=1nF$

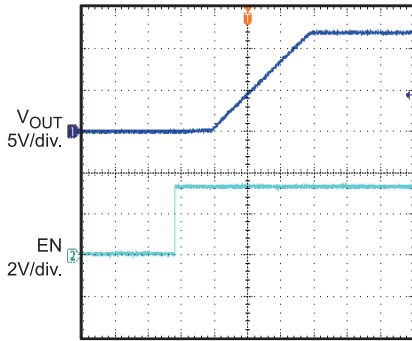

10ms/div.

Turn On Delay and Rise Time with 1 μF Load

$C_{OUT} = 1\mu F$, No Load, $C_{dv/dt}=0$

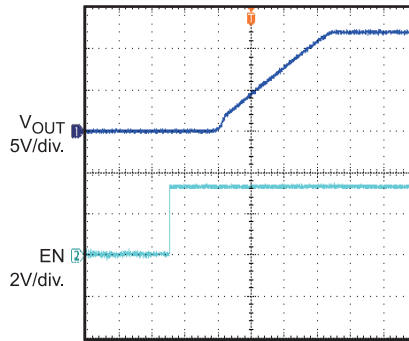

400µs/div.

Turn Off Delay and Fall Time With 10 μF Load

$R_{load} = 3.9\Omega$, $C_{OUT} = 10\mu F$

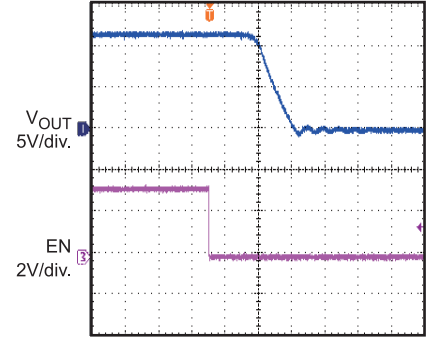

40µs/div.

Short Circuit Current Device Enabled Into Short

$C_{dv/dt}=0$

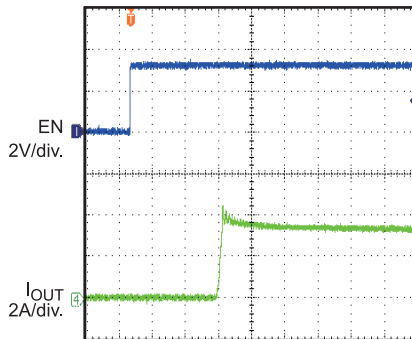

200µs/div.

Short Circuit Current Device Enabled Into Short and Thermal Shut Down (EN Floating)

$C_{dv/dt}=0$

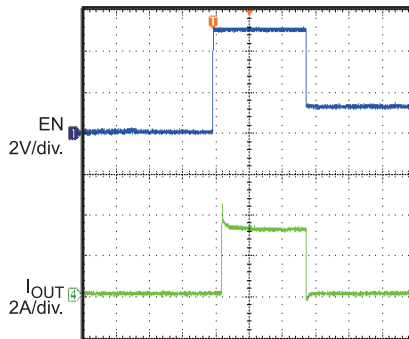

2ms/div.

Trip Current With Ramped Load On Enabled Device (0.01A/µs)

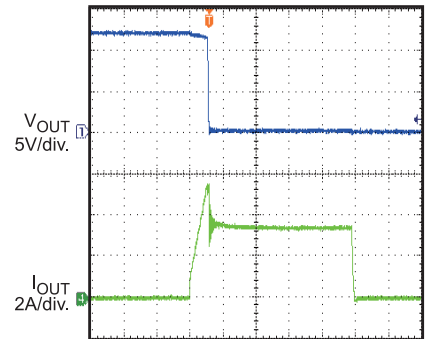

1ms/div.

PRINTED CIRCUIT BOARD LAYOUT

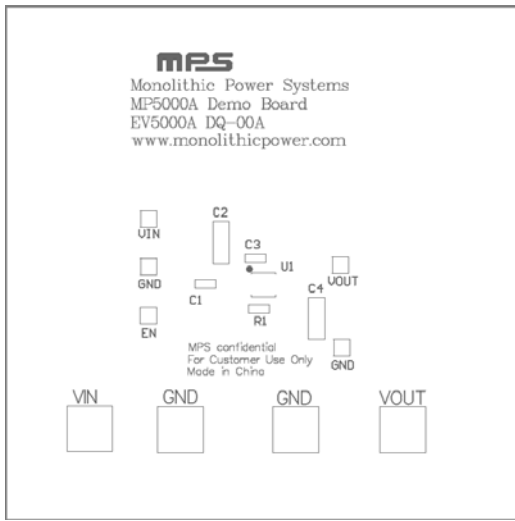

Figure 1—Top Silk Layer

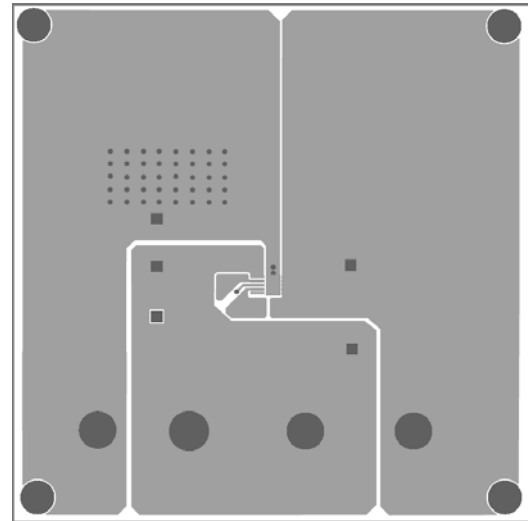

Figure 2—Top Layer

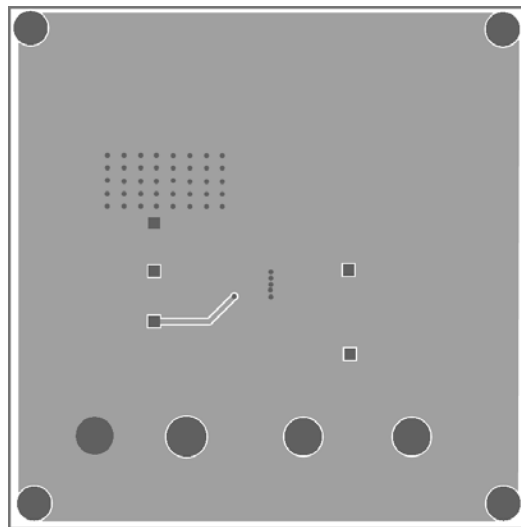

Figure 3—Bottom Layer

QUICK START GUIDE

1. Connect the positive terminal of the load to VOUT pins, and the negative terminal of the load to GND pins.
2. Preset the power supply output to 8.5V – 22V and turn off the power supply.
3. Connect the positive terminal of the power supply output to the VIN pin and the negative terminal of the power supply output to the GND pin.
4. Turn the power supply on. The MP5000ADQ will automatically startup.
5. To use the Enable function, apply a digital input to EN pin. Drive EN higher than 2.5V to turn on the regulator, drive EN less than 0.5V to turn it off.
6. A thermal fault will cause a mid level on the enable pin, and will set the fault flag. Vin restart or a low voltage on EN/FAULT pin can clear fault flag.

NOTICE: The information in this document is subject to change without notice. Users should warrant and guarantee that third party Intellectual Property rights are not infringed upon when integrating MPS products into any application. MPS will not assume any legal responsibility for any said applications.