

DESCRIPTION

The EV5010S-Q-00A is the evaluation board for the MP5010S, a protection device designed to protect circuitry on the output (source) from transients on input (VCC). It also protects VCC from undesired shorts and transients coming from the source.

Besides the input capacitor and output capacitor, EV5010S-Q-00A contains a low power resistor to set the current limit (I_{LIMIT}) as well as a capacitor for dV/dt functions, and the capacitor is optional. The current limit is set to the “trip current (I_{TRIP})” level when the output (source voltage) is near Vcc. As the output decreasing, the current limit is decreased to the “hold current (I_{HOLD})” level.

The demo board defaults are for a 3.6 V turn on point and a 6.65V over voltage clamp. The trip current is set at 3.1A, and the hold current is set at 2.0A (22Ω).

ELECTRICAL SPECIFICATIONS

Parameter	Symbol	Value	Units
Input Voltage	V_{IN}	3.6-18	V
Output Voltage Clamp	V_{OUT}	6.65	V
Trip Current	I_{TRIP}	3.1	A
Hold Current	I_{HOLD}	2.0	A

FEATURES

- Adjustable Slew Rate for Output Voltage
- 3.1A Trip Current and 2.0A Hold Current
- Integrated Power FET Thermal Protection
- Over Voltage Limit
- Low Inrush Current

APPLICATIONS

- Hot Swap
- PC Cards
- Cell Phones
- Laptops

All MPS parts are lead-free and adhere to the RoHS directive. For MPS green status, please visit MPS website under Quality Assurance. “MPS” and “The Future of Analog IC Technology” are Registered Trademarks of Monolithic Power Systems, Inc.

EV5010S-Q-00A EVALUATION BOARD



(L x W x H)
(6.35cm x 6.35cm x 0.3cm)

Board Number	MPS IC Number
EV5010S-Q-00A	MP5010S

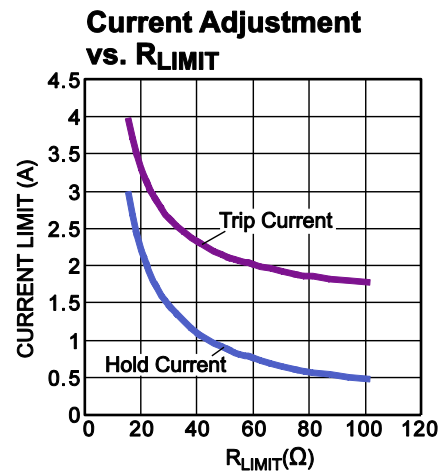

EVALUATION BOARD SCHEMATIC

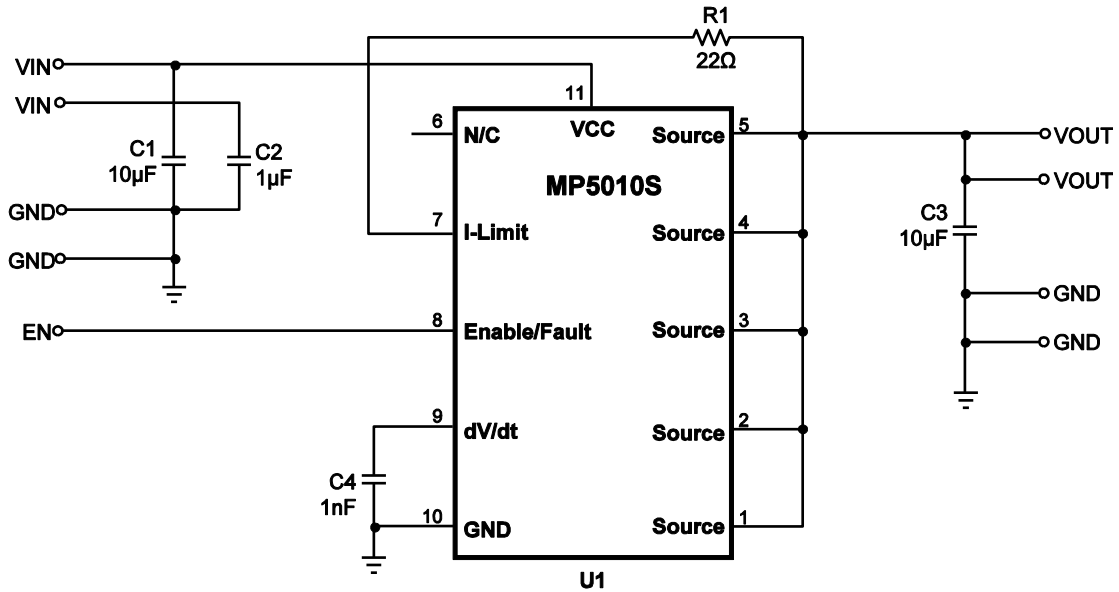

EV5010S-Q-00A BILL OF MATERIALS

Qty	Ref	Value	Description	Package	Manufacturer	Manufacturer P/N
2	C1,C3	10μF/25V	Ceramic Cap., X5R, 25V	1206	Murata	GRM32DR71E106KA12
					TDK	C3216X5R1E106K
1	C2	1μF	Ceramic Cap., X7R, 16V	0603	Murata	GRM188R71C105KA12D
1	C4	1nF	Ceramic Cap., X7R, 50V	0603	Murata	GRM188R71H102KA01D
1	R1	22Ω	Film Res., 1%	0603	Yageo	RC0603FR-0722RL
1	U1		Electronic Fuse	QFN-10	MPS	MP5010S

EVB TEST RESULTS

Performance waveforms are tested on the evaluation board.

$V_{IN} = 5V$, $V_{EN} = 5V$, $R_{LIMIT} = 22\Omega$, $C_{OUT} = 10\mu F$, $C_{dv/dt} = 0nF$, $T_A = 25^\circ C$, unless otherwise noted.

Startup through Input Voltage
En Float, No Load

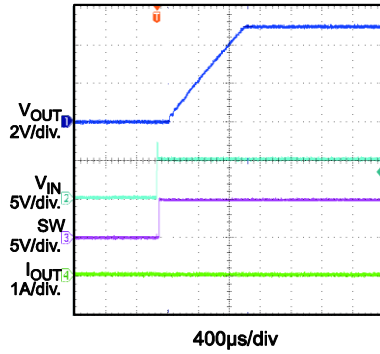

Startup through Input Voltage
En Float, $R_{LOAD} = 3.3\Omega$

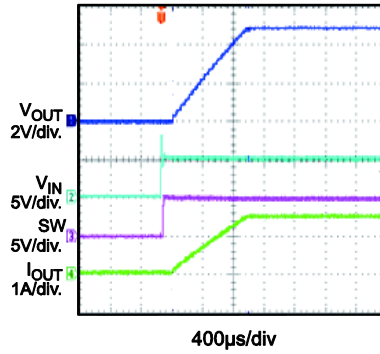

Startup through Input Voltage
En Float, No Load, $C_{OUT} = 2200\mu F$

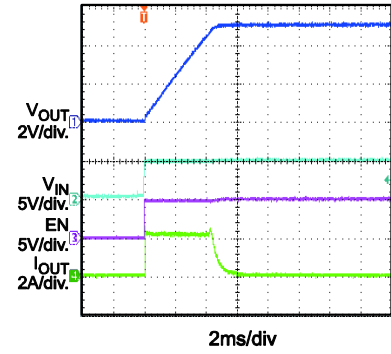

Startup through Enable
No Load

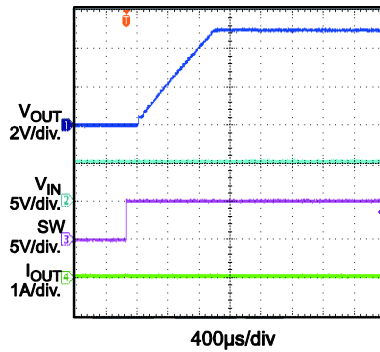

Startup through Enable
 $R_{LOAD} = 3.3\Omega$

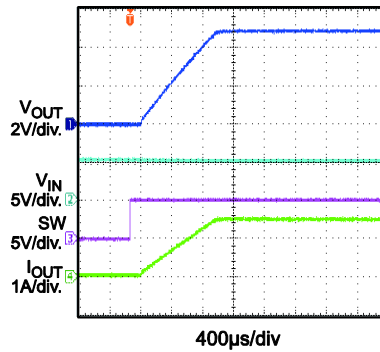

Startup through Enable
No Load, $C_{OUT} = 2200\mu F$

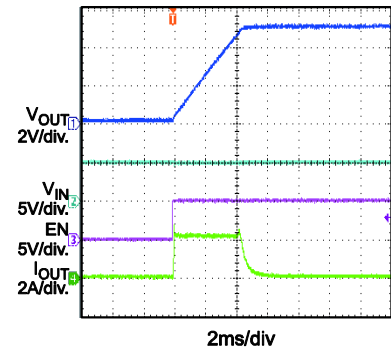

Shutdown through Input Voltage
No Load

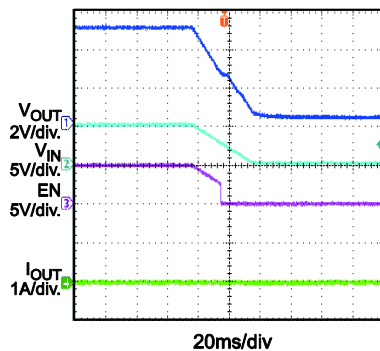

Shutdown through Input Voltage
 $R_{LOAD} = 3.3\Omega$

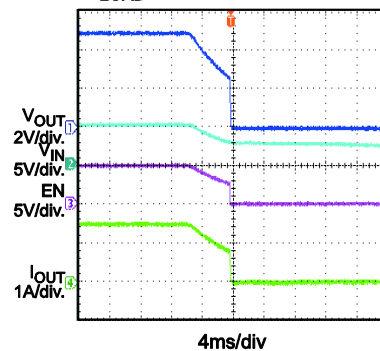

Shutdown through Enable
No Load

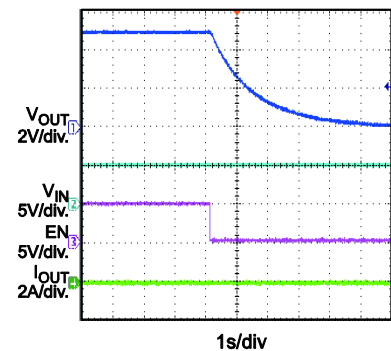

EVB TEST RESULTS *(continued)*

Performance waveforms are tested on the evaluation board.

$V_{IN} = 5V$, $V_{EN} = 5V$, $R_{LIMIT} = 22\Omega$, $C_{OUT} = 10\mu F$, $C_{dv/dt} = 0nF$, $T_A = 25^\circ C$, unless otherwise noted.

Shutdown Through Enable
 $R_{LOAD} = 3.3\Omega$

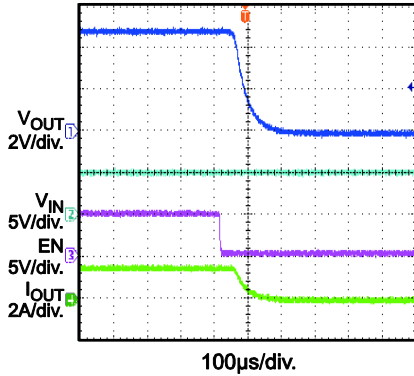

Short Circuit before Input Voltage Startup, and Thermal Shutdown

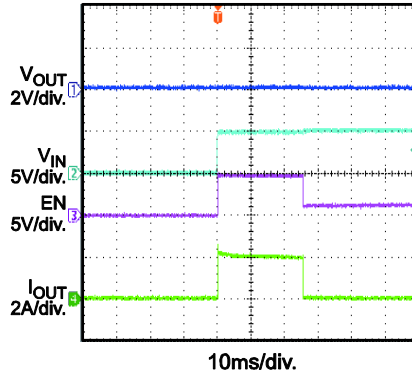

Short Circuit during Normal Operation, and Thermal Shutdown

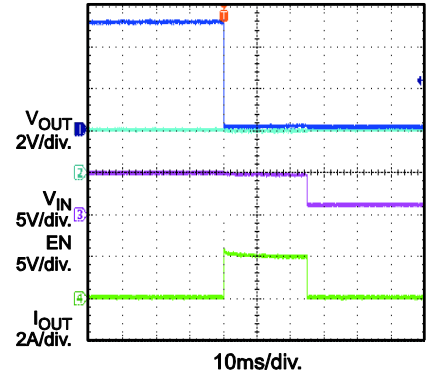

Current Limit

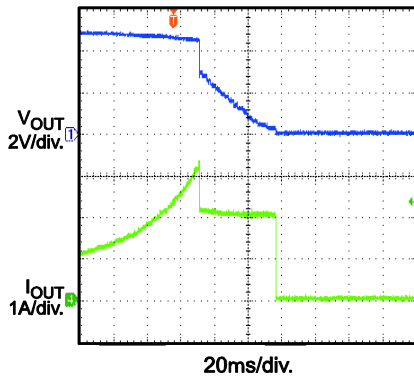

Start Up into OVP, no load EN float
 $V_{IN} = 16V$

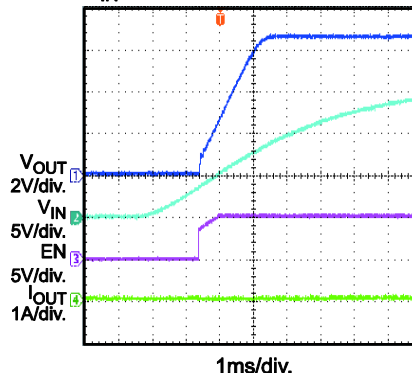

PRINTED CIRCUIT BOARD LAYOUT

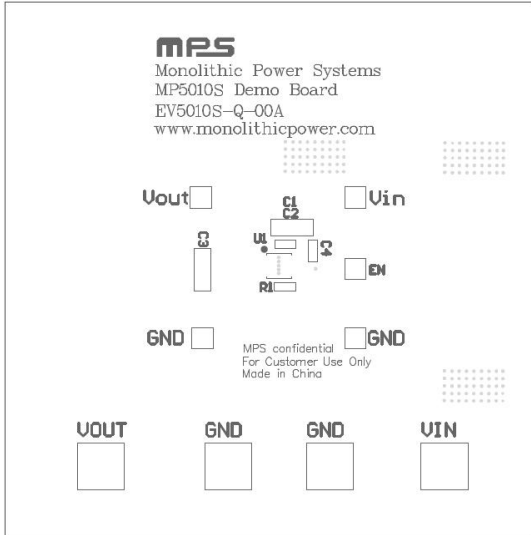

Figure 1—Top Silk Layer

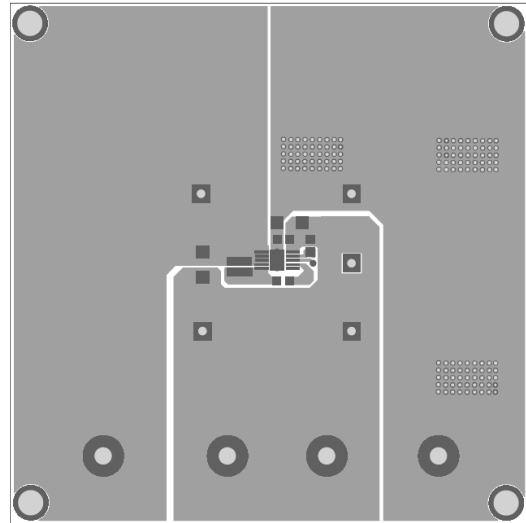

Figure 2—Top Layer

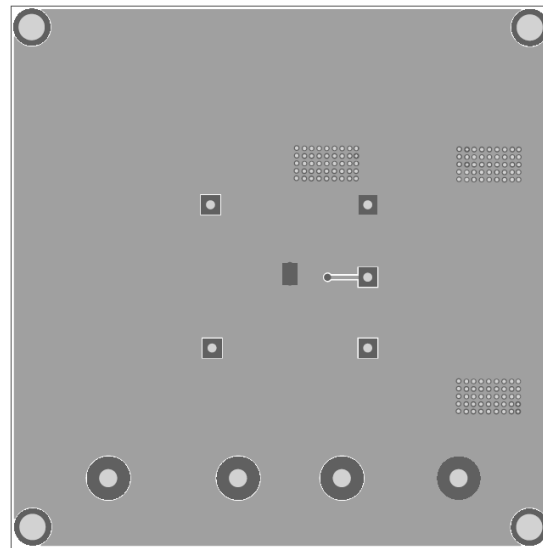

Figure 3—Bottom Layer

QUICK START GUIDE

1. Connect the positive terminal of the load to VOUT pins, and the negative terminal of the load to GND pins.
2. Preset the power supply output to 3.6V-18V and turn off the power supply.
3. Connect the positive terminal of the power supply output to the VIN pin and the negative terminal of the power supply output to the GND pin.
4. Turn the power supply on. The MP5010S will automatically startup.
5. To use the Enable function, apply a digital input to EN pin. Drive EN higher than 2.5V to turn on the regulator, drive EN less than 0.5V to turn it off.
6. A thermal fault will cause a mid level on the enable pin, and will set the fault flag. Vin restart or a low voltage on EN/FAULT pin can clear fault flag.

NOTICE: The information in this document is subject to change without notice. Users should warrant and guarantee that third party Intellectual Property rights are not infringed upon when integrating MPS products into any application. MPS will not assume any legal responsibility for any said applications.