



The Future of Analog IC Technology®

EV5018-D-00A

5V, 1A-5A Current Limit Switch With Reverse Current Blocking Evaluation Board

DESCRIPTION

The MP5018 is a protection device designed to protect circuitry on the output from transients on input (V_{CC}). It also protects V_{CC} from undesired shorts and transients coming from the output.

At startup, inrush current is limited by the slew rate at the output. The slew rate is controlled by a small capacitor at the SS pin. Floating the SS pin provides 13ms soft-start time.

The maximum load at the output is current limited. The magnitude of the current limit is controlled by an external resistor from ILIMIT to GND. Floating ILIMIT pin provides 3A fixed current limit. By controlling the gate voltage of a pair of N-channel MOSFETs, any current flowing from output to input is blocked.

Under Voltage Lockout (UVLO) assures that input is above the minimum operating threshold, before the power device is turned on. If input voltage goes above 5.8V, the output voltage will be limited at 5.8V with fast response.

The EN/Fault pin is a bi-directional, three-level I/O with a weak pull-up. It can be used to enable or disable MP5018, or indicate a fault condition.

The device is available in a QFN12 (2mmx3mm) package.

The demo board defaults are for a 4.5V turn on point and a 5.8V over voltage clamp. The current limit is set at 3A.

ELECTRICAL SPECIFICATION

Parameter	Symbol	Value	Units
Continued Operation Input Voltage	V_{IN}	4.5-5.5	V
Maximum Transient Input Voltage	V_{INMAX}	16	V
Output Clamp Voltage	V_{OVLO}	5.8	V
Current Limit	I_{LIMIT}	3	A

FEATURES

- SAS Disable to support DEVSLP or POWER_DOWN
- 4.5V to 5.5V Continuous Operating Input Range
- 16V Absolute Maximum Input Voltage
- 5.8V Fast OVP Response
- Reverse Current Blocking
- Integrated 45mΩ Power FET
- Adjustable Current-Limit or Fixed Current Limit when floating ILIMIT pin
- 210µA Typical Low Quiescent Current
- Adjustable Soft Start time
- Fault Indication
- Latch-off Thermal Protection
- Available in QFN12(2mmx3mm) Package
- ESD Compliant to 2kV HBM and 1kV CDM

APPLICATIONS

- HDD, SSD
- Hot Swap Systems
- Gaming
- Set-top Boxes/Smart TV
- PCIe Cards
- Switches/Routers

All MPS parts are lead-free and adhere to the RoHS directive. For MPS green status, please visit MPS website under Products, Quality Assurance page.

"MPS" and "The Future of Analog IC Technology", are Registered Trademarks of Monolithic Power Systems, Inc.

EV5018-D-00A EVALUATION BOARD

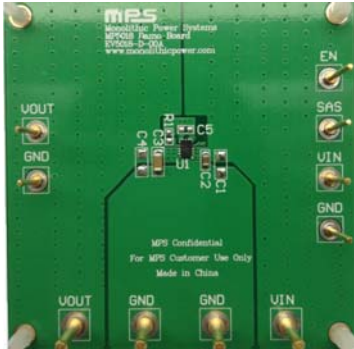

(L x W x H) 6.35cm x 6.35cm x 0.3cm

Board Number	MPS IC Number
EV5018-D-00A	MP5018GD

Current limit vs. R_{LIMIT}

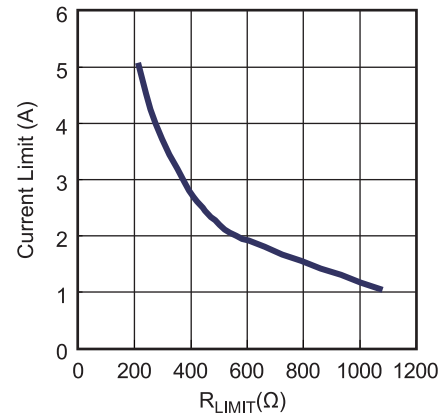

EVALUATION BOARD SCHEMATIC

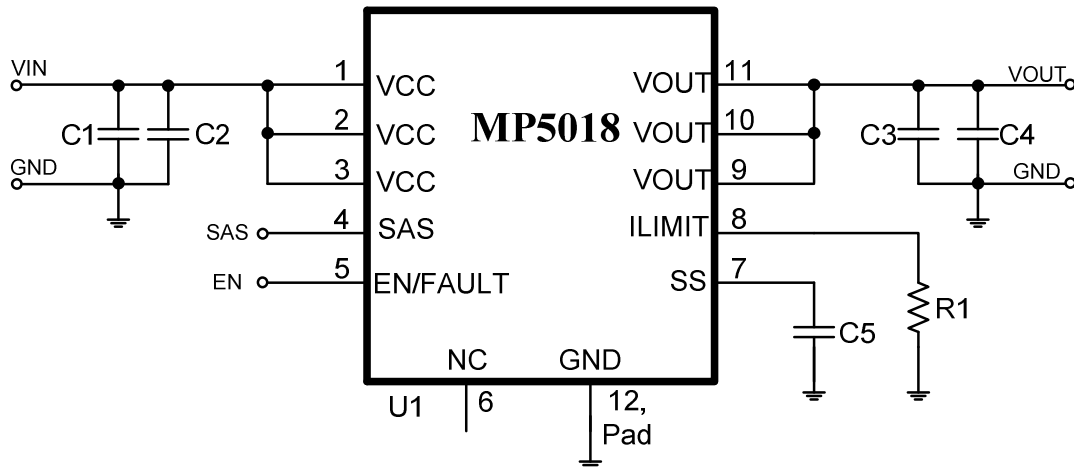

EVB Schematic

EV5018-D-00A BILL OF MATERIALS

Qty	Ref	Value	Description	Package	Manufacturer	Part Number
0	C1,C4,C5	NS				
1	C2	1 μ F	Ceramic Cap, 16V, X7R	0805	muRata	GRM21BR71C105KA01L
1	C3	22 μ F	Ceramic Cap, 16V, X7R	1206	muRata	GRM31CR71C226KAC7L
1	U1	MP5018GD	Electronic Fuse	QFN12(2x3)	MPS	MP5018GD
0	R1	NS				

EVB TEST RESULTS

$V_{IN}=5V$, $V_{EN}=5V$, I_{LIMIT} Pin Float, SS Pin Float, SAS Pin Float, $C_{OUT}=22\mu F$, $T_A=25^\circ C$, unless otherwise noted.

Startup through Input Voltage

En Float, No Load

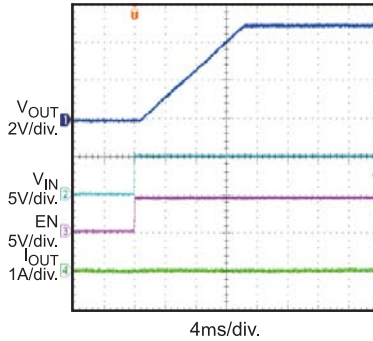

Startup through Input Voltage

En Float, $R_{LOAD} = 3.3\Omega$

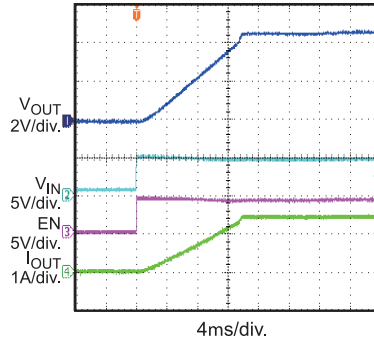

Startup through Input Voltage

En Float, No Load, $C_{OUT} = 2200\mu F$

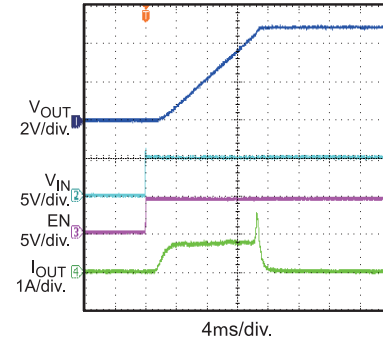

Startup through Enable

No Load

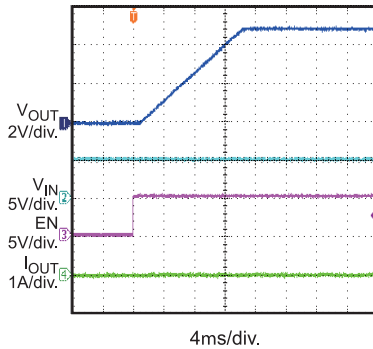

Startup through Enable

$R_{LOAD} = 3.3\Omega$

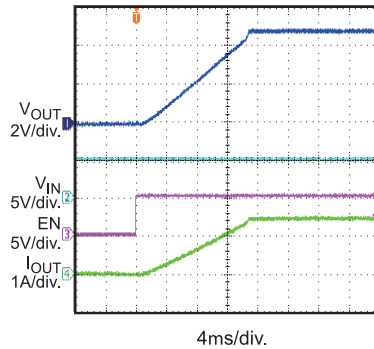

Startup through Enable

No Load, $C_{OUT} = 2200\mu F$

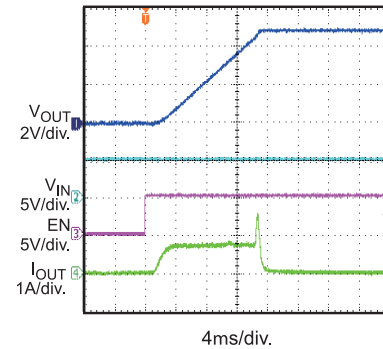

Startup through SAS

No Load

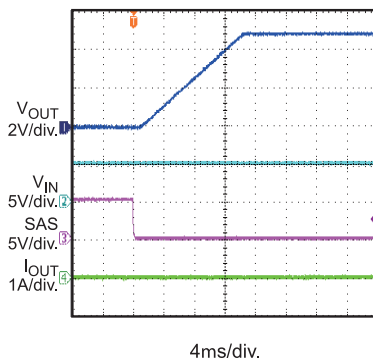

Startup through SAS

$R_{LOAD}=3.3\Omega$

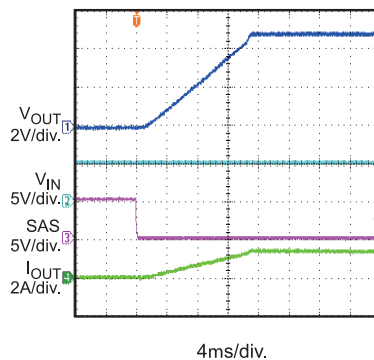

Startup through SAS

No Load, $C_{OUT}=2200\mu F$

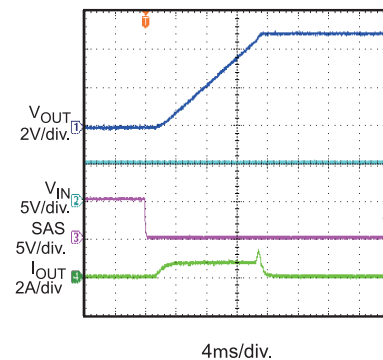

EVB TEST RESULTS (continued)

$V_{IN}=5V$, $V_{EN}=5V$, I_{LIMIT} Pin Float, SS Pin Float, SAS Pin Float, $C_{OUT}=22\mu F$, $T_A=25^\circ C$, unless otherwise noted.

Shutdown through Input Voltage

No Load

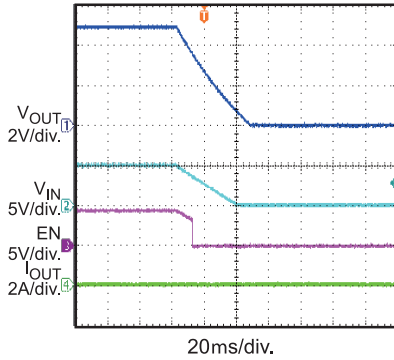

Shutdown through Input Voltage

$R_{LOAD}=3.3\Omega$

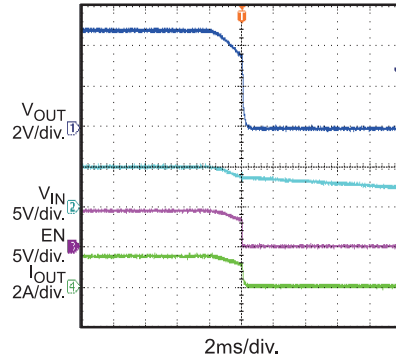

Shutdown through Enable

No Load

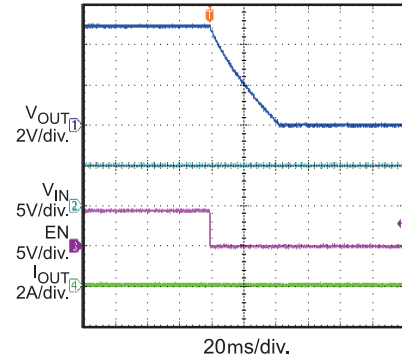

Shutdown through Enable

$R_{LOAD}=3.3\Omega$

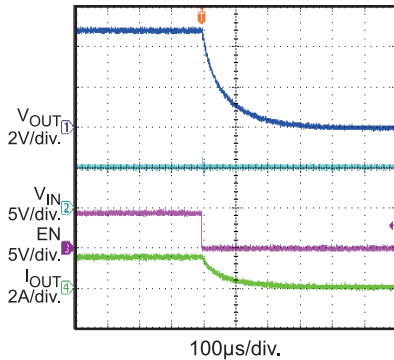

Shutdown through SAS

No Load

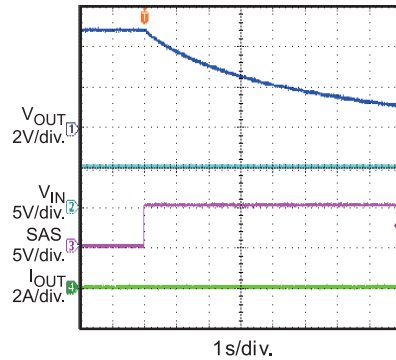

Shutdown through SAS

$R_{LOAD}=3.3\Omega$

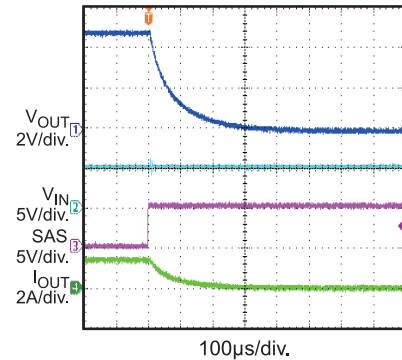

Short Circuit before Input Voltage Startup, and Thermal Shutdown

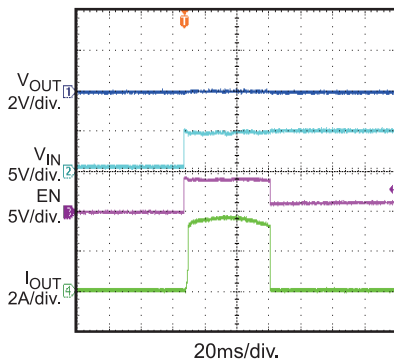

Short Circuit during Normal Operation, and Thermal Shut Down

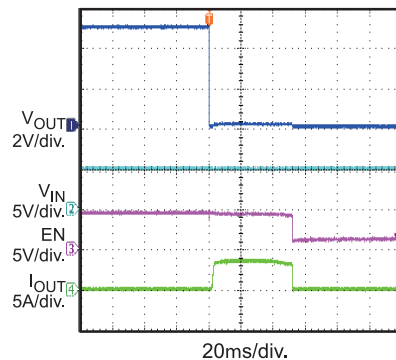

OVP Response

V_{IN} from 5V to 7.5V

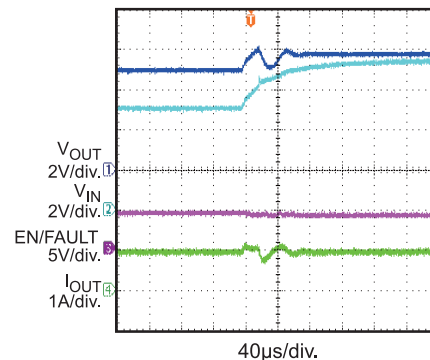

EVB TEST RESULTS *(continued)*

$V_{IN}=5V$, $V_{EN}=5V$, I_{LIMIT} Pin Float, SS Pin Float, SAS Pin Float, $C_{OUT}=22\mu F$, $T_A=25^\circ C$, unless otherwise noted.

Current Limit
Increase I_{OUT} Slowly

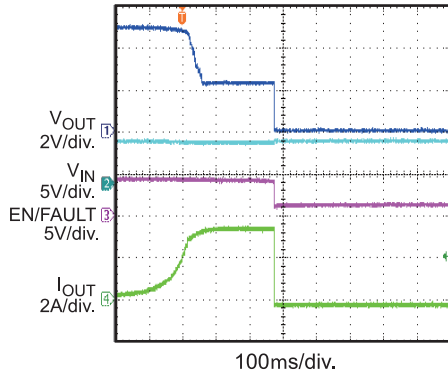

PRINTED CIRCUIT BOARD LAYOUT

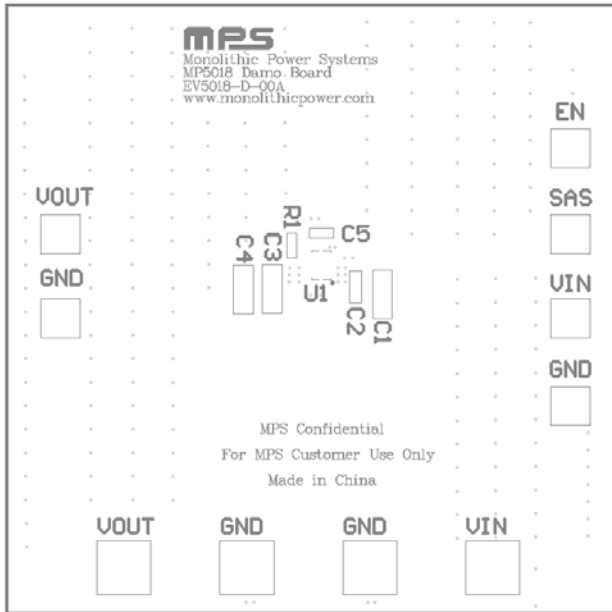

Figure 1—Top Silk Layer

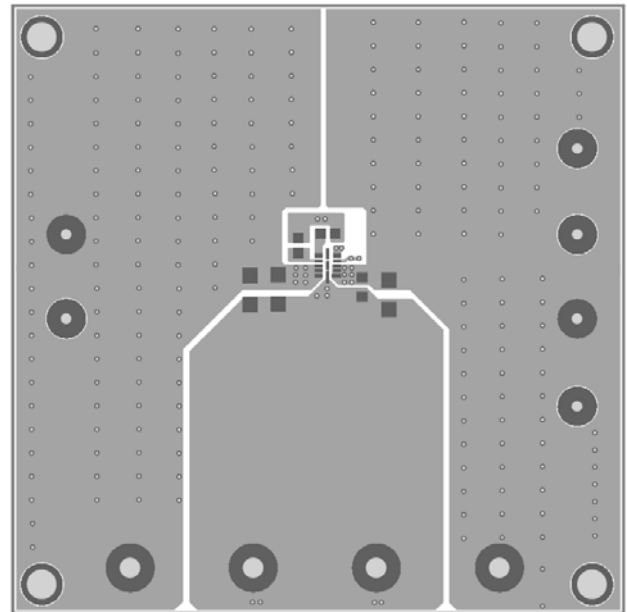

Figure 2—Top Layer

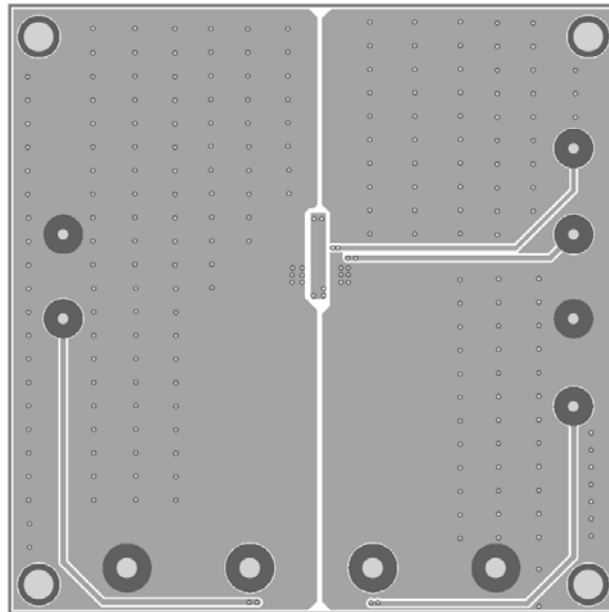

Figure 3—Bottom Layer

QUICK START GUIDE

1. Connect the positive terminal of the load to VOUT pins, and the negative terminal of the load to GND pins.
2. Preset the power supply output to 4.5V-5.5V and turn off the power supply.
3. Connect the positive terminal of the power supply output to the VIN pin and the negative terminal of the power supply output to the GND pin.
4. Turn the power supply on. The MP5018GD will automatically startup.
5. To use the Enable function (Float the SAS pin or pull it to GND), apply a digital input to EN/FAULT pin. Drive EN/FAULT higher than 3.3V to turn on the regulator, drive EN less than 0.35V to turn it off.
6. To use the SAS function (Float the EN/FAULT pin or pull it higher than 3.3V), apply a digital input to SAS pin. Drive SAS less than 0.35V to turn on the regulator, drive SAS higher than 2.1V to turn it off.
7. A thermal fault will cause a mid level on the enable pin, and will set the fault flag. Vin restart or a low voltage on EN/FAULT pin can clear fault flag.
8. The current value of this board is set to 3A, and the output voltage rising time is set to 13ms. Both of the two parameters can be programmed. For detailed application, please refer to the MP5018GD datasheet.

NOTICE: The information in this document is subject to change without notice. Please contact MPS for current specifications. Users should warrant and guarantee that third party Intellectual Property rights are not infringed upon when integrating MPS products into any application. MPS will not assume any legal responsibility for any said applications.