

DESCRIPTION

The MP5030 integrates a USB current limit switch and charging port identification circuit. It achieves 3A continuous output current over a wide input supply range.

The output of USB switch is current limit programmable. MP5030 supports DCP schemes for Battery Charging specification (BC1.2), the divider Mode, 1.2V/1.2V Mode and Quick Charge specification (QC 3.0) without the need for external user interaction. It also supports Type-C 5V@3A DFP mode.

MP5030 provides linear line drop compensation.

Fault protection includes hiccup current limiting, input OVP and thermal shutdown.

The MP5030 is available in QFN-10(1.5mmx2mm) package.

ELECTRICAL SPECIFICATION

Parameter	Symbol	Value	Units
System Input Voltage	V_{IN}	14	V
Default Output Voltage	V_{OUT}	5.15	V
Output Current	I_{OUT}	3	A

FEATURES

- 9V to 16V Operating Input Voltage Range
- 36V Absolutely Input Voltage
- Support QC 3.0 (3.6V-12Vout with 1% accuracy) and DCP schemes for BC 1.2, Divider Mode, 1.2V/1.2V Mode
- Line Drop Compensation for 5V Output
- Programmable High Accuracy Current Limit and Fairly Constant Power Limit
- 32mΩ Low- $R_{DS(ON)}$ Power MOSFET
- Input Discharge during high voltage to low voltage change
- Intelligent Input over Voltage Shutdown Protection
- Compatible with Buck, Boost, ACDC converters

APPLICATIONS

- USB Power Supplies
- AC/DC Wall Adapter with USB Ports
- Automotive Cigarette Lighter Adapters Power Bank

All MPS parts are lead-free and adhere to the RoHS directive. For MPS green status, please visit MPS website under Products, Quality Assurance page.

"MPS" and "The Future of Analog IC Technology", are Registered Trademarks of Monolithic Power Systems, Inc.

EV5030-QH-00C EVALUATION BOARD



(L×W)5.8cm×3.3cm

Board Number	MPS IC Number
EV5030-QH-00C	MP5030GQH

EVALUATION BOARD SCHEMATIC

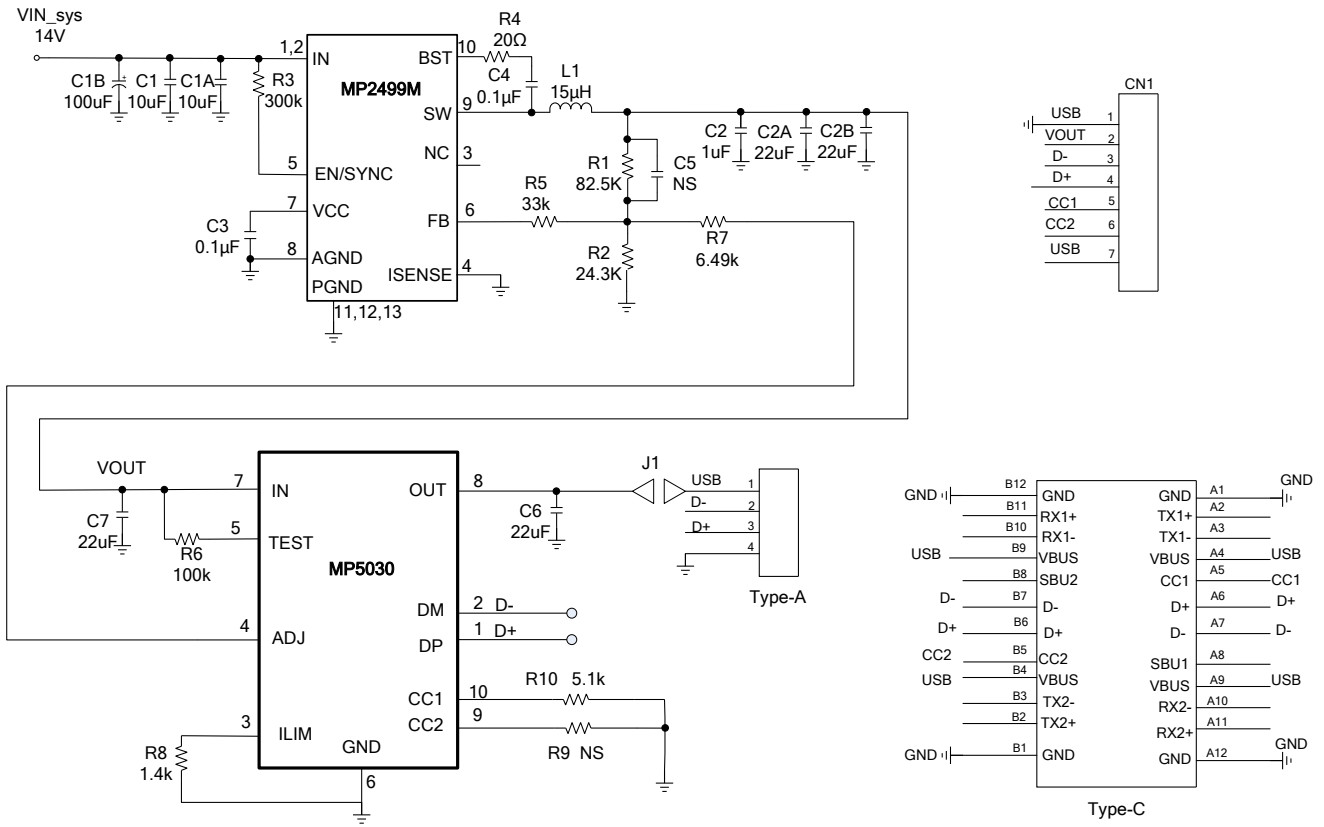

EV5030-QH-00CBILL OF MATERIALS

Qty	Ref	Value	Description	Package	Manufacturer	Part Number
2	C1,C1A	10 μ F	Ceramic Cap, 35V, X5R	0805	Murata	GRM21BR61E106KA43L
1	C1B	100 μ F	E- Cap., 50V	DIP	Würth	860080674009
1	C2	1 μ F	Ceramic Cap, 16V, X5R	0603	Murata	GRM188R71C105KA12D
4	C2A, C2B, C6, C7	22 μ F	Ceramic Cap, 25V, X5R	0805	Murata	GRM21BR61E226ME44L
2	C3,C4	0.1 μ F	Ceramic Cap, 25V, X7R	0603	Murata	GRM188R71E104KA01D
0	C5	NS				
1	R1	82.5k	Thick Film Res., 1%	0603	Yageo	RC0603FR-0782K5L
1	R2	24.3k	Thick Film Res., 1%	0603	Yageo	RC0603FR-0724K3L
1	R3	300k	Thick Film Res., 1%	0603	Yageo	RC0603FR-07300KL
1	R4	20 Ω	Thick Film Res., 1%	0603	Yageo	RC0603JR-0720RL
1	R5	33k	Thick Film Res., 1%	0603	Yageo	RL0603FR-0733KL
1	R6	100k	Thick Film Res., 1%	0603	Yageo	RL0603FR-07100KL
1	R7	6.49k	Thick Film Res., 1%	0603	Yageo	RC0603FR-076K49L
1	R8	1.4k	Thick Film Res., 1%	0603	Yageo	RC0603FR-071K4L
0	R9	NS				
1	R10	5.1k	Thick Film Res., 1%	0603	Yageo	RC0603FR-075K1L
1	L1	15 μ H	Inductor, DCR=20m Ω max, Is=3A	COIL	UEC (威盛科)	WL-853
1	U1	MP2499M	Synchronous Step- Down Converter	QFN13 (2.5mmx3mm)	MPS	MP2499M
1	U2	MP5030	QC3.0 Controller with USB Current Limit SW	QFN- 10(1.5mmx2mm)	MPS	MP5030
1	Type-A	Type-A	USB type-A port	Tray	Würth	61400416021
1	Type-C	Type-C	USB type-C port	Tray	Würth	632723300011

EVB TEST RESULTS

$V_{IN} = 5V$, $V_{OUT} = 5V$, $R_{ILIM} = 1.4k\Omega$, $T_A = 25^\circ C$, CC1 pull-down by 5.1k resistor to ground, unless otherwise noted.

Start-Up through VIN

$I_{OUT} = 0A$

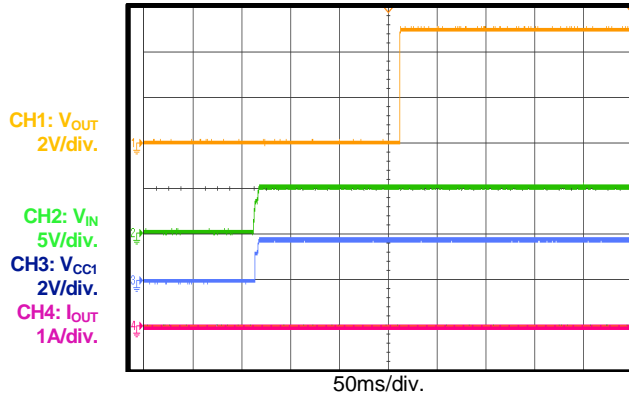

Shutdown through VIN

$I_{OUT} = 0A$

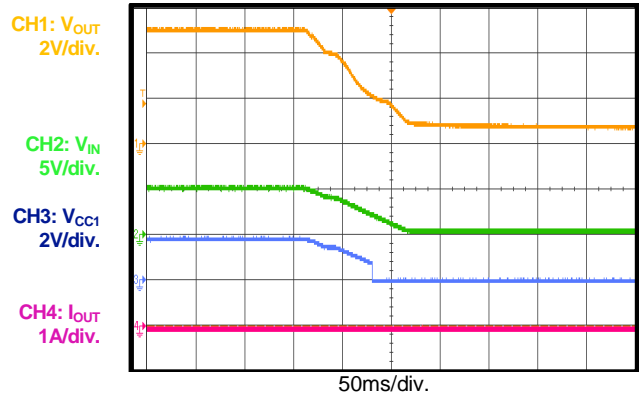

Mode Transition from 5V to 9V

$I_{OUT} = 0A$, from QC 2.0_5V to 9V

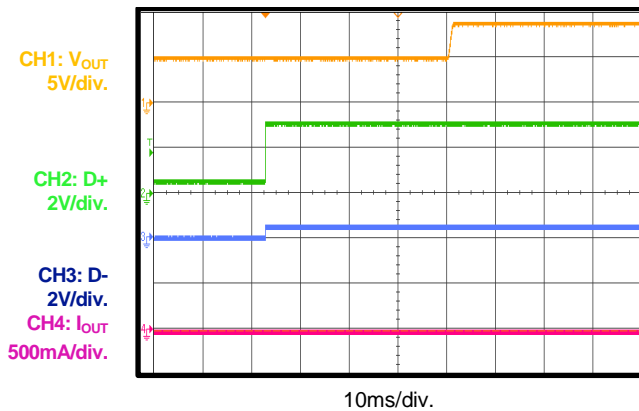

Mode Transition from 9V to 5V

$I_{OUT} = 0A$, from QC 2.0_9V to 5V

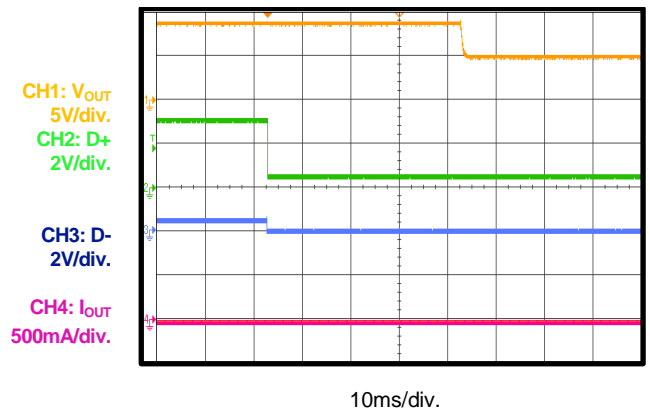

Input Over-Voltage Protection

QC 5V Mode, $I_{OUT} = 0A$

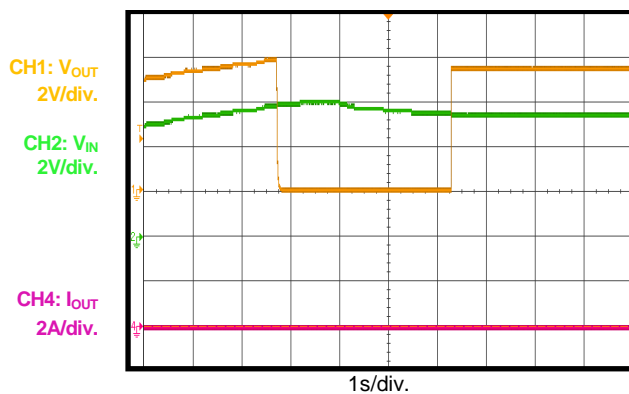

Input Over-Voltage Protection

QC 9V Mode, $I_{OUT} = 0A$

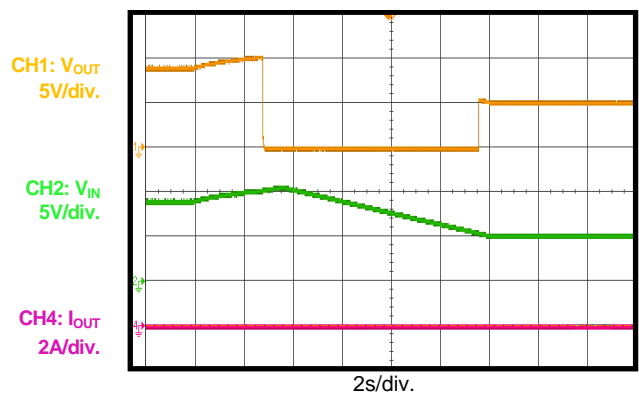

EVB TEST RESULTS (continued)

$V_{IN} = 5V$, $V_{OUT} = 5V$, $R_{ILIM} = 1.4k\Omega$, $T_A = 25^\circ C$, CC1 pull-down by 5.1k resistor to ground, unless otherwise noted.

Short-Circuit Protection Entry and Recovery

$V_{IN} = 5V$, $I_{OUT} = 0A$

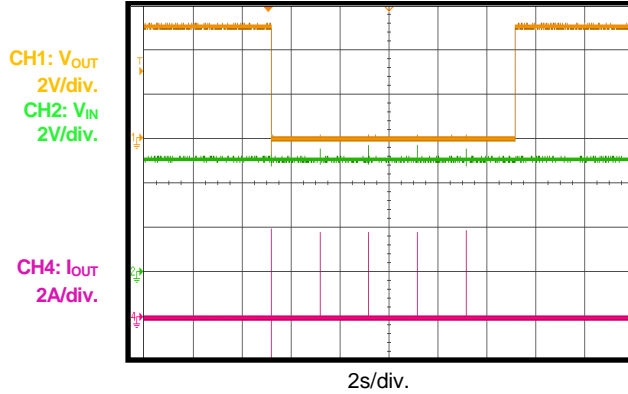

Short-Circuit Protection Entry and Recovery

$V_{IN} = 9V$, $I_{OUT} = 0A$

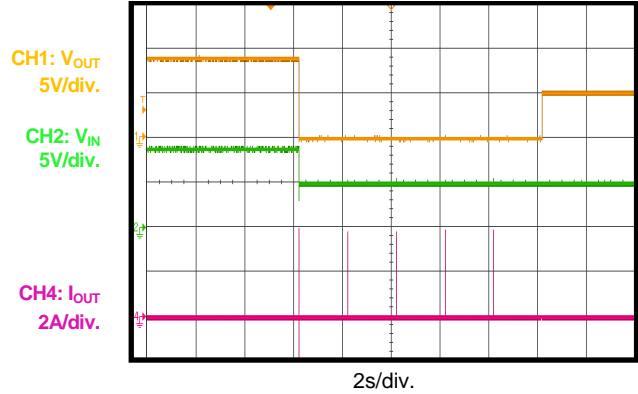

QC 3.0 Device Charging Test

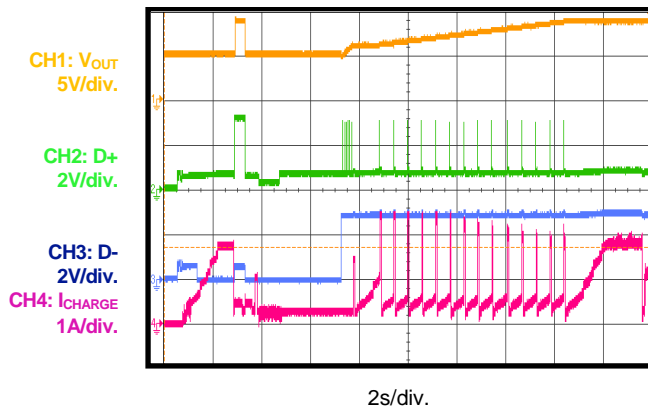

Type-C Mode Test

Remove CC1 pull-down resistor, plug Type-C Phone into MP5030

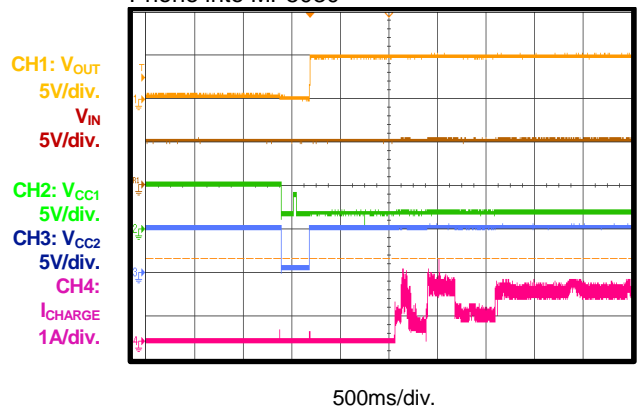

Type-C Mode Test

Remove CC1 pull-down resistor, plug out Type-C Phone from MP5030

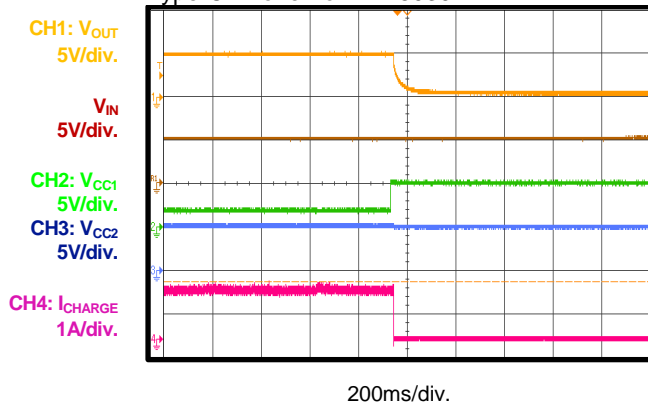

PRINTED CIRCUIT BOARD LAYOUT

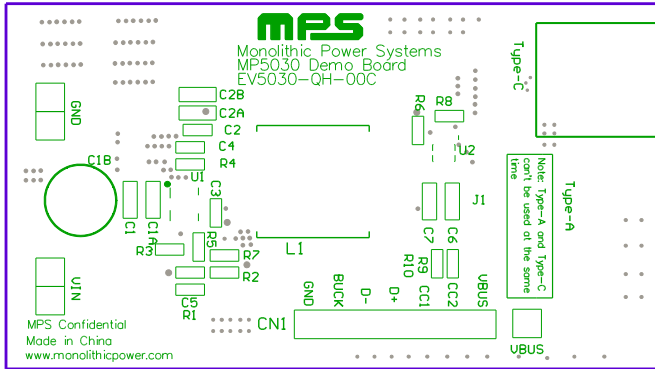

Figure 1: Top Silkscreen Layer

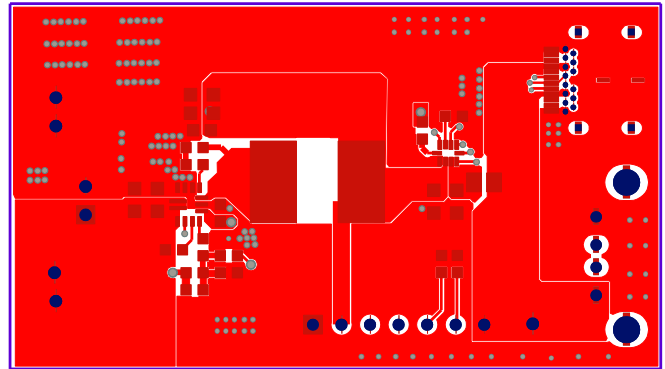

Figure 2: Top Layer

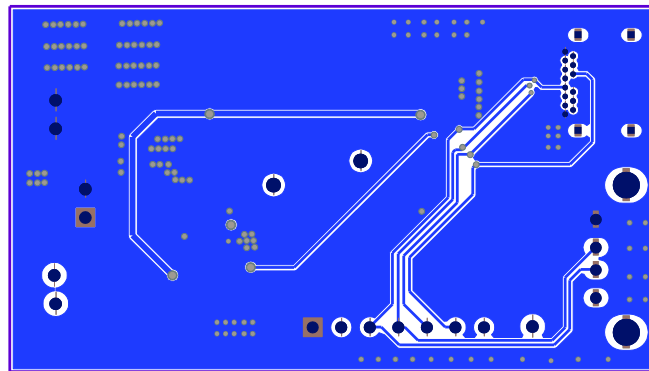

Figure 3: Bottom Layer

QUICK START GUIDE

1. Preset Power Supply to 14V.
2. Turn Power Supply off.
3. Connect Power Supply terminals to:
 - a. Positive (+): VIN
 - b. Negative (-): GND
4. Turn Power Supply on after making connections. The board will automatically start up.
5. Connect different mobile phones to Type-A or Type-C USB port for charging test. Note that Type-A and Type-C port can't be used at the same time. When Type-C phone is connected, remove R10 (5.1k) on board.

NOTICE: The information in this document is subject to change without notice. Please contact MPS for current specifications. Users should warrant and guarantee that third party Intellectual Property rights are not infringed upon when integrating MPS products into any application. MPS will not assume any legal responsibility for any said applications.