

DESCRIPTION

The EV5036-J-00A Evaluation Board is designed to demonstrate the capabilities of MPS' MP5036, a protection device designed to protect circuitry on the output from transients on input. It also protects input from undesired shorts and transients coming from the output. MP5036 is a small R_{ON} , low quiescent current, current limited switch.

At startup, the inrush current is limited by limiting the slew rate at the output. The slew rate is controlled by a capacitor at the DV/DT pin.

The maximum load at the output is current limited. The magnitude of the current limit is controlled by an external resistor from ILIMIT to GND. There is a fixed 2.5A current limit when floating ILIMIT pin.

The output voltage is limited by the output over voltage protection (OVP) function.

The MP5036 is available in a space-saving 8 pin-TSOT23-6 package.

ELECTRICAL SPECIFICATION

Parameter	Symbol	Value	Units
Input Voltage	V_{IN}	12	V
Output Current	I_{OUT}	3	A

FEATURES

- Wide 2.9V to 14V Continued Operating Input Range
- 26V Absolute Maximum Transient Input Voltage
- Fixed 15V Over Voltage Clamp Threshold
- Fast Output OVP Response
- Integrated 43mΩ Power FET
- Adjustable Current-Limit or Fixed Current Limit when floating ILIMIT pin
- Soft Start Time Programmable through DV/DT pin
- Fast Response for Hard Short Protection
- OCP Hiccup Protection
- Thermal Shutdown and Auto Retry
- Available in TSOT23-6 Package

APPLICATIONS

- Hard Disk Drives
- Solid State Drives
- Hot Swap

All MPS parts are lead-free, halogen free, and adhere to the RoHS directive. For MPS green status, please visit MPS website under Quality Assurance. "MPS" and "The Future of Analog IC Technology" are Registered Trademarks of Monolithic Power Systems, Inc.

EV5036-J-00A EVALUATION BOARD

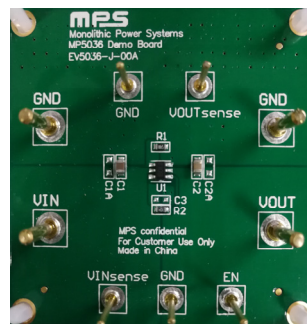

(L × W × H) 54mm x 46mm x 6.4mm

Board Number	MPS IC Number
EV5036-J-00A	MP5036GJ

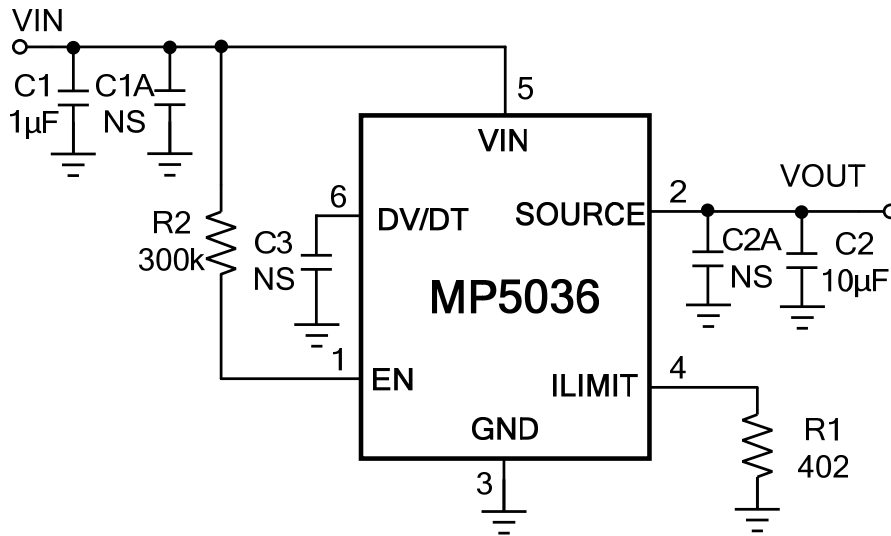
EVALUATION BOARD SCHEMATIC

EV5036-J-00A BILL OF MATERIALS

Qty	Ref	Value	Description	Package	Manufacturer	Part Number
1	C1	1 μ F	Ceramic Cap.,25V,X7R	0805	Murata	GRM21BR71E105KA99L
1	C2	10 μ F	Ceramic Cap.,25V,X5R	0805	Murata	GRM21BR61E106KA73L
0	C1A, C2A, C3	NS				
1	R1	402 Ω	Thick Film Res., 1%	0603	Yageo	RC0603FR-07402L
1	R2	300k Ω	Thick Film Res., 1%	0603	Yageo	RC0603FR-07300KL
1	U1	MP5036GJ	Current limit switch	TSOT23-6	MPS	MP5036GJ

EVB TEST RESULTS

$V_{IN}=12V$, $V_{EN}=5V$, $R_{LIMIT}=402\Omega$, DV/DT float, $C_{OUT}=10\mu F$, $T_A=25^\circ C$, unless otherwise noted.

Start-Up through Input Voltage

$I_{OUT}=0A$

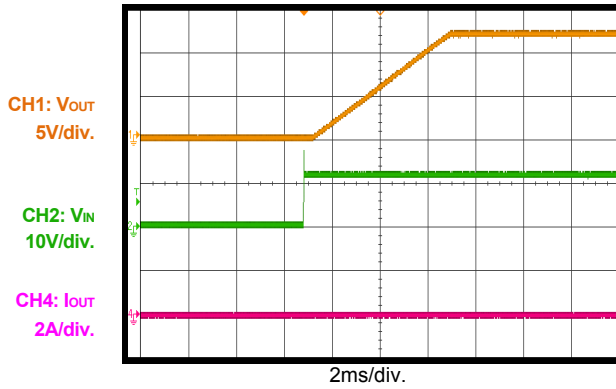

Start-Up through Input Voltage

$I_{OUT}=3A$

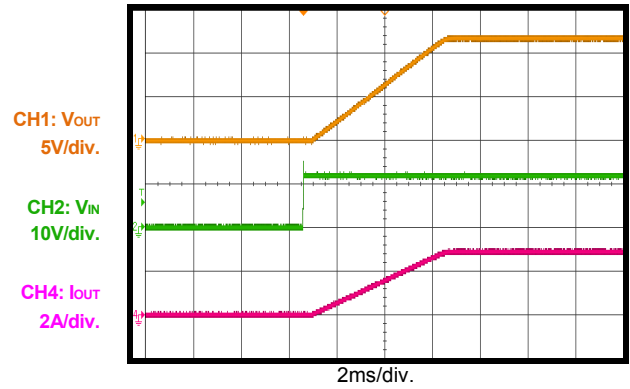

Start-Up through Input Voltage

$I_{OUT}=0A$, $C_{OUT}=1000\mu F$

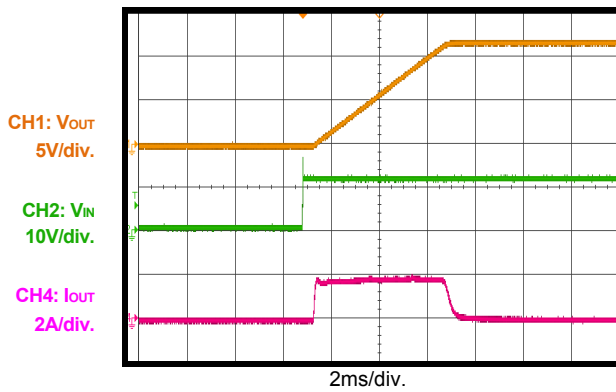

Shutdown through Input Voltage

$I_{OUT}=0A$

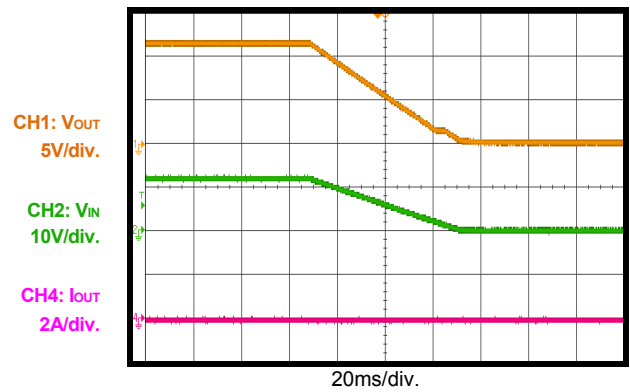

Shutdown through Input Voltage

$I_{OUT}=3A$

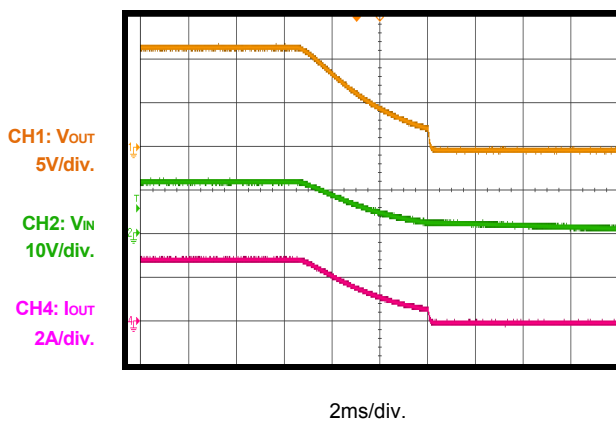

Start-Up through Enable

$I_{OUT}=0A$

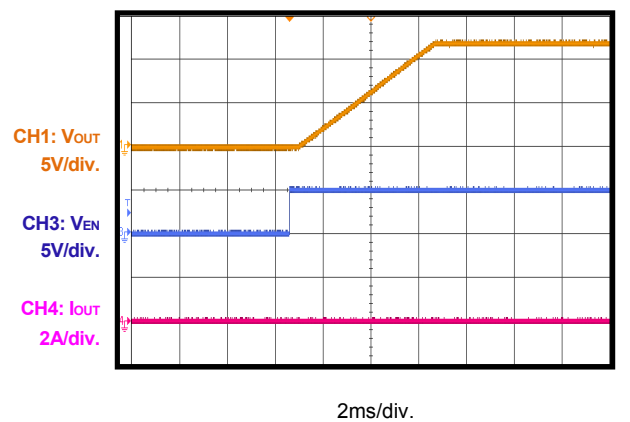

EVB TEST RESULTS (continued)
 $V_{IN}=12V$, $V_{EN}=5V$, $R_{LIMIT}=402\Omega$, DV/DT float, $C_{OUT}=10\mu F$, $T_A=25^\circ C$, unless otherwise noted.

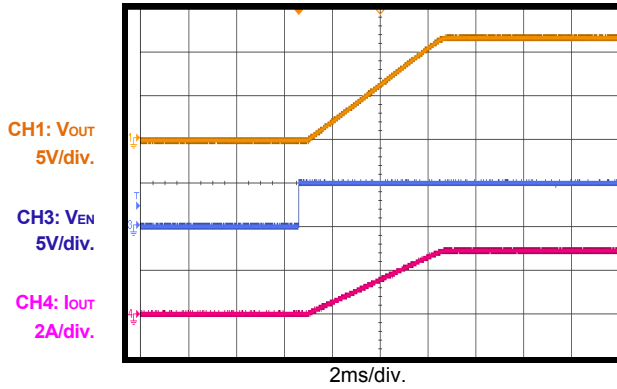
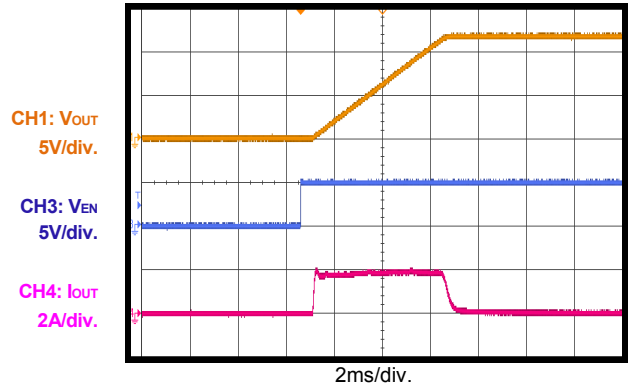
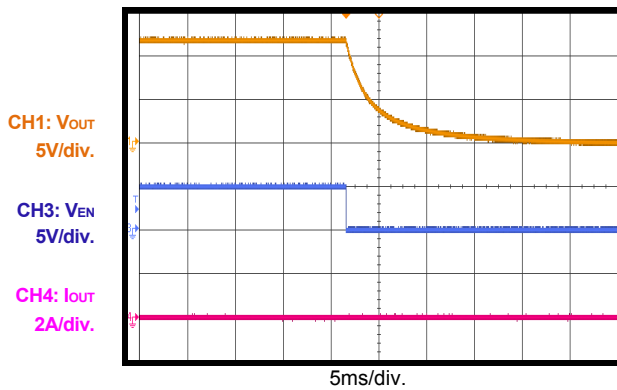
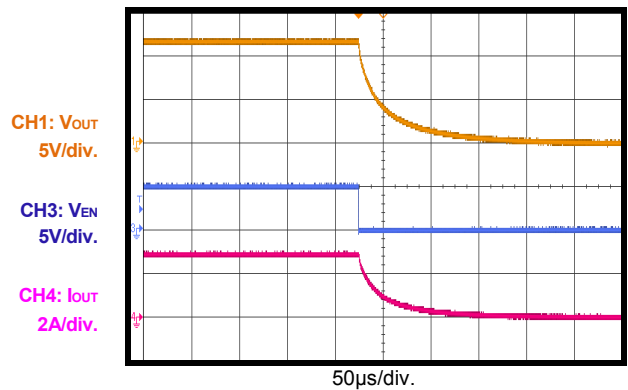
Start-Up through Enable
 $I_{OUT}=3A$

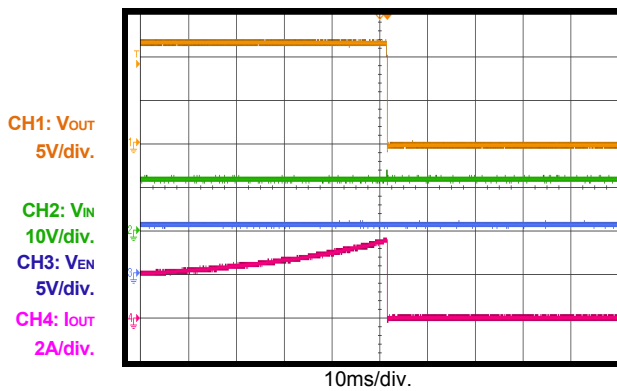
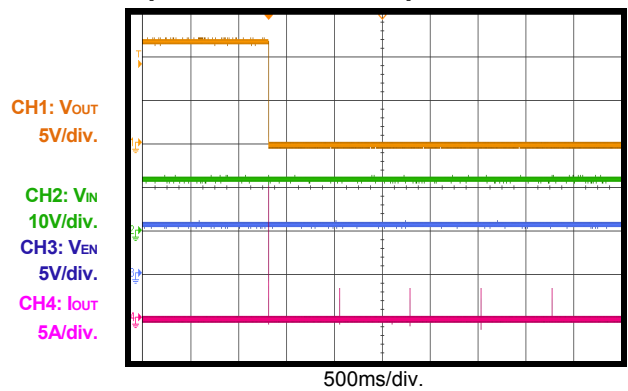
Start-Up through Enable
 $I_{OUT}=0A$, $C_{OUT}=1000\mu F$

Shutdown through Enable
 $I_{OUT}=0A$

Shutdown through Enable
 $I_{OUT}=3A$

Current Limit

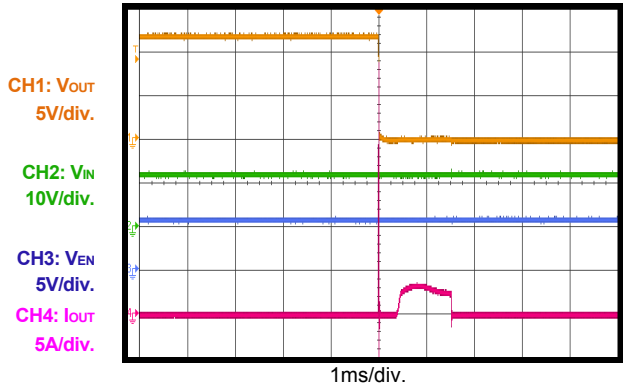
 Increase I_{out} slowly

Short Circuit during Normal Operation and Hiccup

EVB TEST RESULTS *(continued)*

$V_{IN}=12V$, $V_{EN}=5V$, $R_{LIMIT}=402\Omega$, DV/DT float, $C_{OUT}=10\mu F$, $T_A=25^\circ C$, unless otherwise noted.

Short Circuit Entry during Normal Operation



Short Circuit before Input Voltage Start-Up

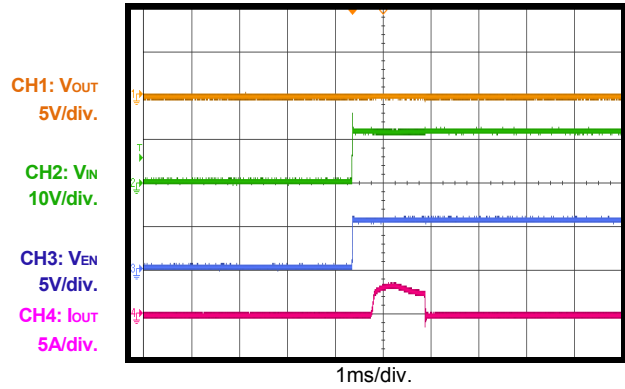

PRINTED CIRCUIT BOARD LAYOUT

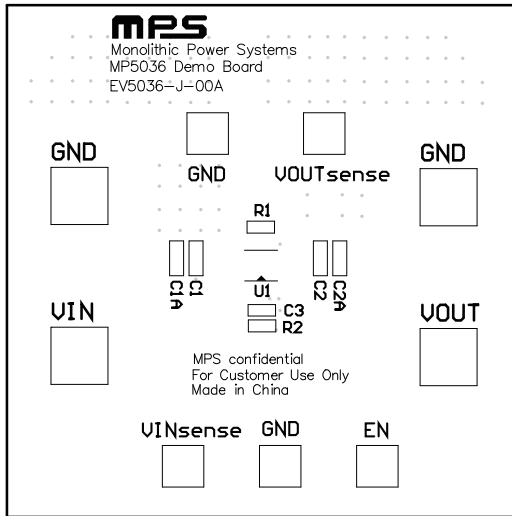

Figure 1: Top Silk Layer

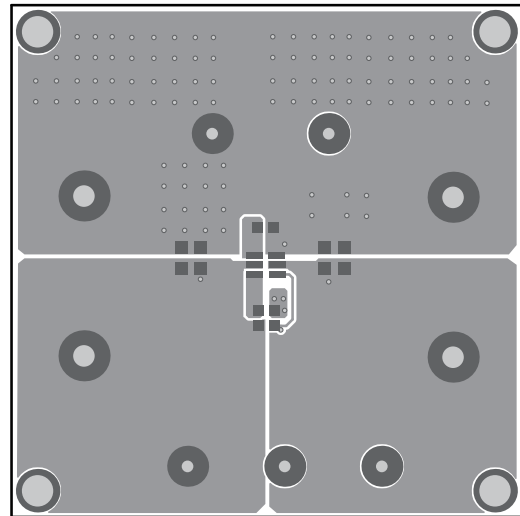

Figure 2: Top Layer

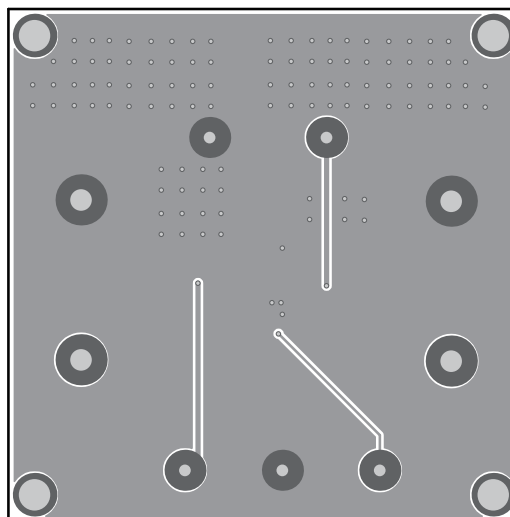

Figure 3: Bottom Layer

QUICK START GUIDE

1. Preset V_{IN1} Power Supply to 12V.
2. Turn Power Supply off.
3. Connect Power Supply terminals to:
 - a. Positive (+): V_{IN}
 - b. Negative (-): GND
4. Connect Load to:
 - a. Positive (+): V_{OUT}
 - b. Negative (-): GND
5. Turn Power Supply on after making connections. The board will automatically start up.
6. To use the Enable function, apply a digital input to the EN pin. Drive EN higher than 2.2V to turn on the regulator, or less than 1.5V to turn it off.

NOTICE: The information in this document is subject to change without notice. Please contact MPS for current specifications. Users should warrant and guarantee that third party Intellectual Property rights are not infringed upon when integrating MPS products into any application. MPS will not assume any legal responsibility for any said applications.