

DESCRIPTION

The EV5073-G-00B is an evaluation board for the MP5073, a low R_{DS(on)} load switch with current limit.

The MP5073 is a load switch to provide 2A load protection covering 0.5V to 5.5V voltage range. With the small R_{DS(on)} in tiny package, MP5073 provides very high efficient and space saving solution in notebook and tablet or other portable devices application.

The max load at the output (source) is current limited. This is accomplished by utilizing a sense FET topology. The magnitude of the current limit is controlled by an external resistor from the ILIM pin to ground.

The EV board can deliver a continuous 2A load current over 0.5V-to-5.5V operating input range.

ELECTRICAL SPECIFICATION

Parameter	Symbol	Value	Units
Input Voltage ⁽¹⁾	V _{IN}	0.8-5.5	V
Output Voltage	V _{CC}	3-5.5	V
Output Current	I _{OUT}	2	A

Note:

1) For specifications of lower voltage, please contact factory.

FEATURES

- Integrated 50mΩ Low RDSON FETs
- Adjustable Start Up Slew Rate
- Wide VIN Range from 0.5V to 5.5V
- <1uA Shutdown Current
- Programmable 2.5A Current Limit Range
- Power Good Indicator
- Output Discharge function
- Enable Pin
- <200ns Short-Circuit Protection Response Time
- Thermal Protection
- Small 2mmx2mmQFN Package for Space Saving

APPLICATIONS

- Notebook and Tablet Computers
- Portable Devices
- Solid State Drives
- Handheld Devices

All MPS parts are lead-free, halogen free, and adhere to the RoHS directive. For MPS green status, please visit MPS website under Quality Assurance. "MPS" and "The Future of Analog IC Technology" are Registered Trademarks of Monolithic Power Systems, Inc.

EV5073-G-00B EVALUATION BOARD



(L x W x H) 6.4cm x 6.4cm x 1.3cm

Board Number	MPS IC Number
EV5073-G-00B	MP5073GG

R_{DS(on)} vs. V_{CC}

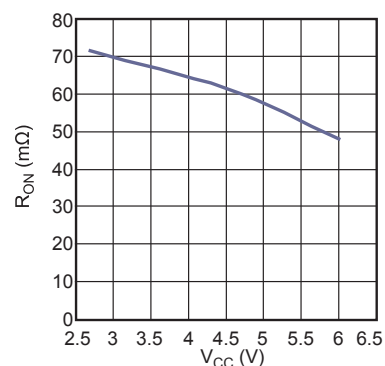

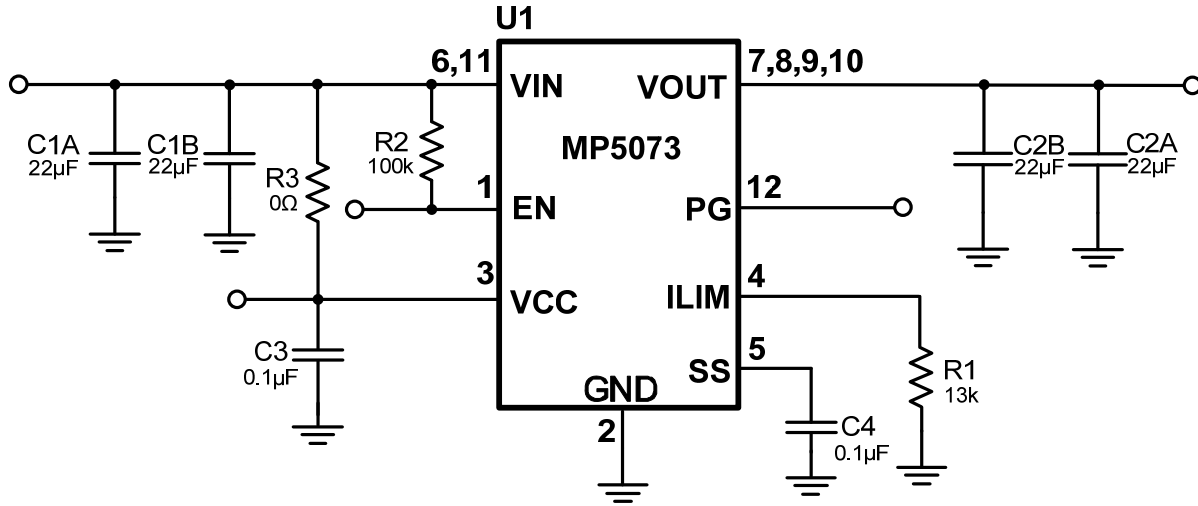
EVALUATION BOARD SCHEMATIC

EV5073-G-00B BILL OF MATERIALS

Qty	Ref	Value	Description	Package	Manufacturer	Manufacturer P/N
1	R1	13kΩ	Film Res,1%	0603	ROYAL	RL0603FR-0713KL
1	R2	100kΩ	Film Res,1%	0603	ROYAL	RL0603FR-07100KL
1	R3	0Ω	Film Res,1%	0603	ROYAL	RC0603FR-070RL
4	C1A,C1B, C2A,C2B	22µF	Ceramic Cap,10V,X5R	0805	muRata	GRM21BR61A226ME51L
2	C3,C4	0.1µF	Ceramic Cap,16V,X7R	0603	muRata	GRM188R71C104KA01D
1	U1	MP5073	2A Load Switch	QFN 2x2	MPS	MP5073GG

EVB TEST RESULTS

Performance waveforms are tested on the evaluation board.

$V_{IN} = 3.6V$, $V_{CC} = 3.6V$, $EN=2.5V$, $R_{LIM} = 13k$, $T_A = 25^{\circ}C$, unless otherwise noted.

VCC Standby Current vs. VCC

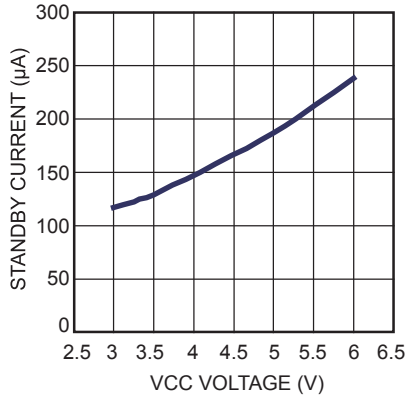

Disabled Supply Current vs. Input Voltage

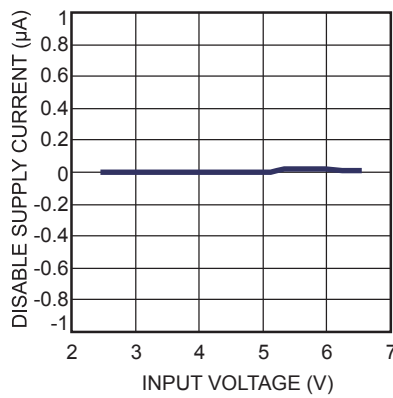

UVLO vs. Temperature

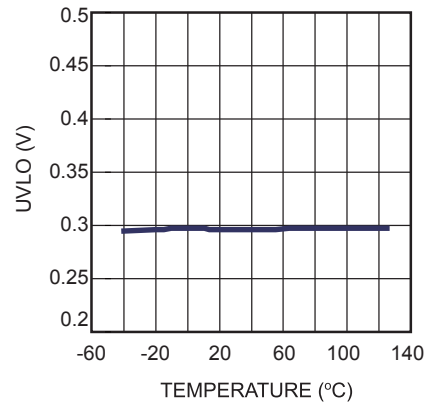

EN Rising Threshold vs. Temperature

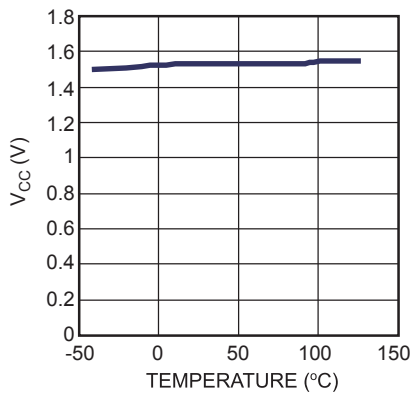

R_{DS_ON} vs. VCC

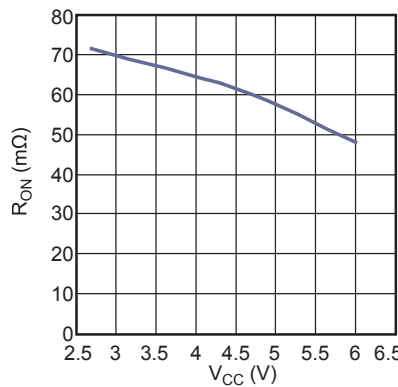

R_{DS_ON} vs. Temperature

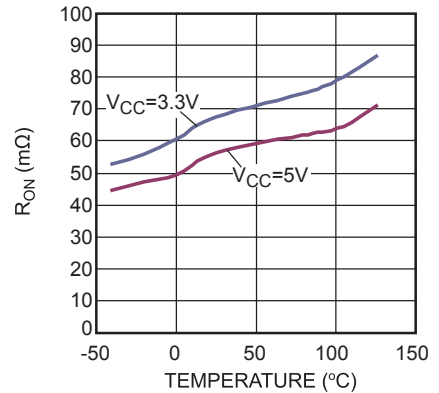

The Maximum Limit vs. V_{IN}

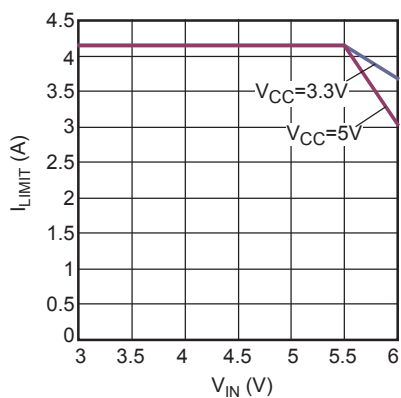

Current Limit vs. R_{LIMIT}

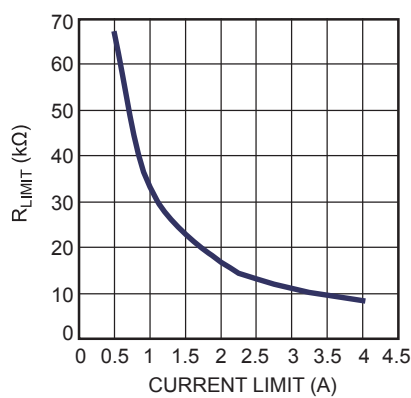

Soft-Start vs. Cap
 $V_{IN}=3.6V$

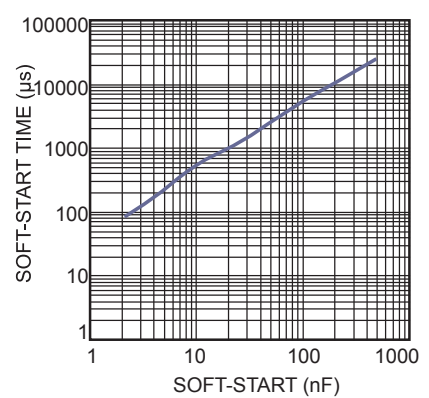

EVB TEST RESULTS *(continued)*

Performance waveforms are tested on the evaluation board.

$V_{IN} = 3.6V$, $V_{CC} = 3.6V$, $EN=2.5V$, $R_{LIM} = 13k$, $T_A = 25^{\circ}C$, unless otherwise noted.

Input-to-Output Voltage vs. Load Current

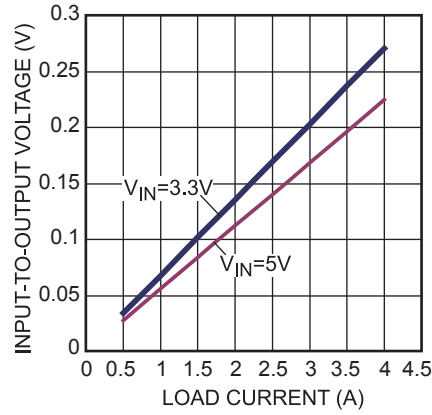

Case Temperature Rise vs. Output Current

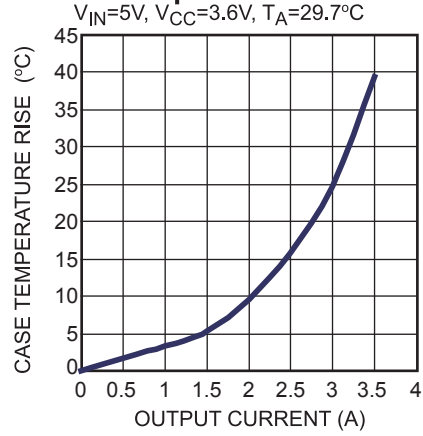

EVB TEST RESULTS *(continued)*

Performance waveforms are tested on the evaluation board.

$V_{IN} = 3.6V$, $V_{CC} = 3.6V$, $EN=2.5V$, $R_{LIM} = 13k$, $T_A = 25^\circ C$, unless otherwise noted.

Enable Startup

$V_{IN} = 5V$, $V_{CC} = 3.6V$, No Load

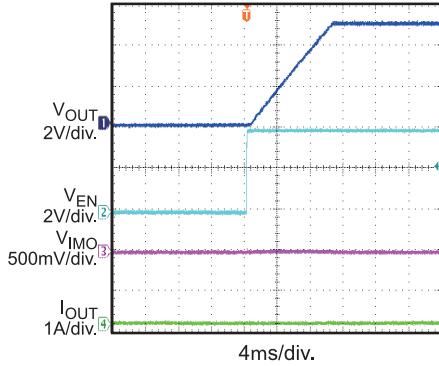

Enable Startup

$V_{IN} = 5V$, $V_{CC} = 3.6V$, 2.5A Load

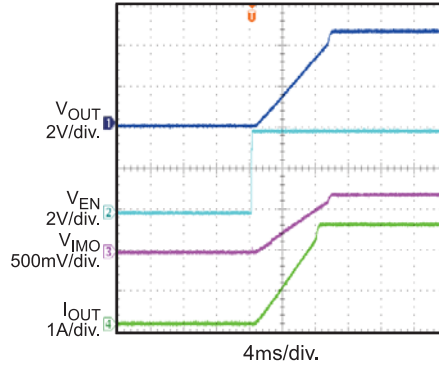

Enable Shutdown

$V_{IN} = 5V$, $V_{CC} = 3.6V$, No Load

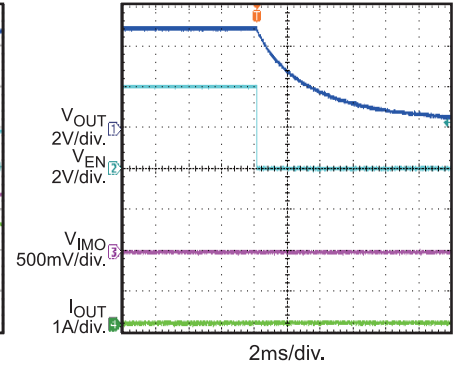

Enable Shutdown

$V_{IN} = 5V$, $V_{CC} = 3.6V$, 2.5A Load

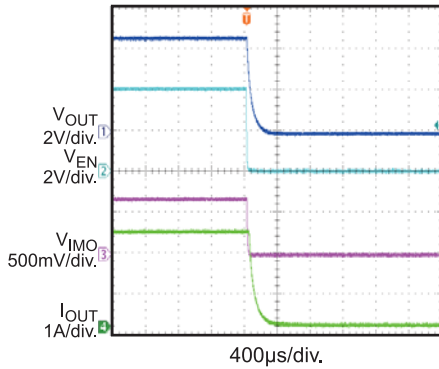

Power Up

$V_{IN} = 5V$, $V_{CC} = 3.6V$, $I_{OUT} = 0A$

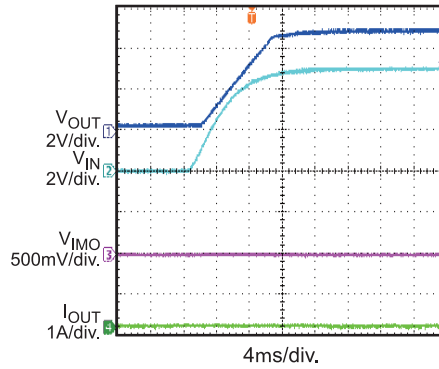

Power Up

$V_{IN} = 5V$, $V_{CC} = 3.6V$, $I_{OUT} = 2.5A$

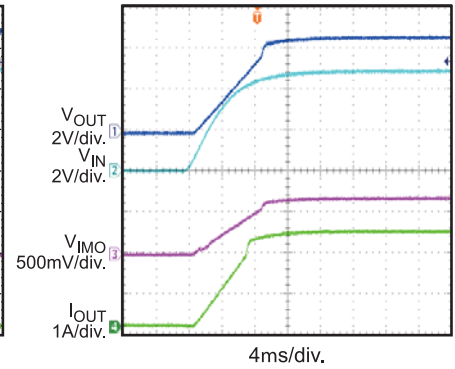

Power Down

$V_{IN} = 5V$, $V_{CC} = 3.6V$, $I_{OUT} = 0A$

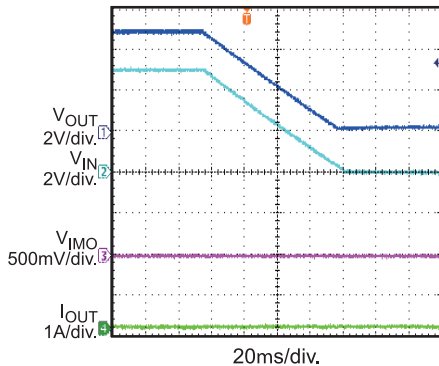

Power Down

$V_{IN} = 5V$, $V_{CC} = 3.6V$, $I_{OUT} = 2.5A$

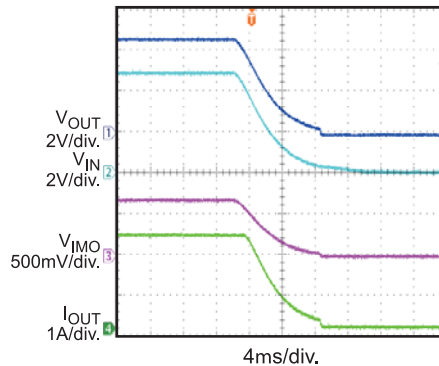

Steady State

$V_{IN} = 5V$, $V_{CC} = 3.6V$, $I_{OUT} = 2A$

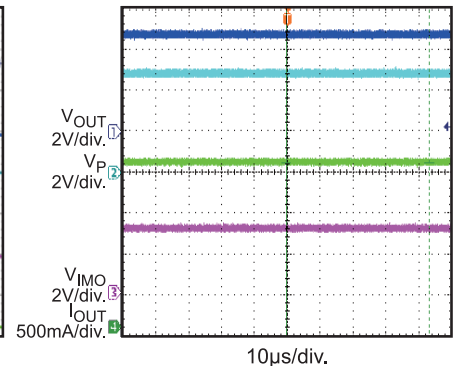

EVB TEST RESULTS (continued)

Performance waveforms are tested on the evaluation board.

$V_{IN} = 3.6V$, $V_{CC} = 3.6V$, $EN=2.5V$, $R_{LIM} = 13k$, $T_A = 25^{\circ}C$, unless otherwise noted.

Load Transient Response

$V_{IN} = 3.6V$, $V_{CC} = 3.6V$, $I_{OUT} = 0A-2.5A$

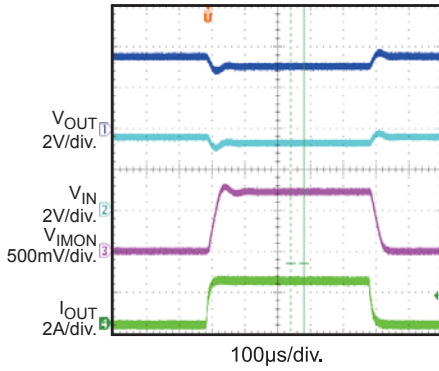

SCP Enter

$V_{IN} = 5V$, $V_{CC} = 3.6V$

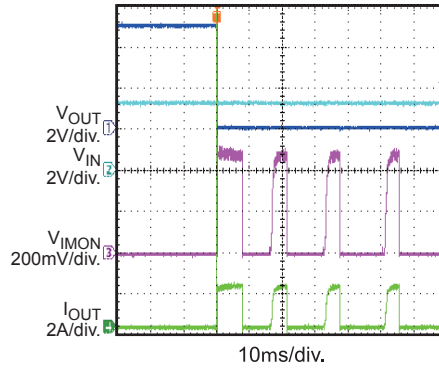

SCP Steady State

$V_{IN} = 5V$, $V_{CC} = 3.6V$

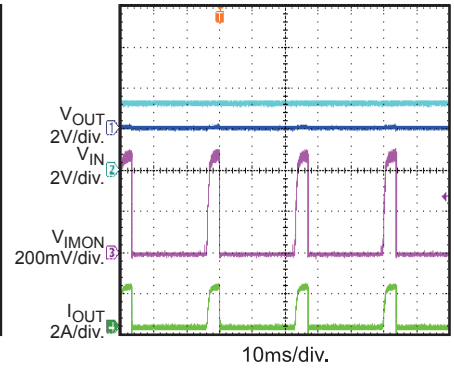

SCP Recovery

$V_{IN} = 5V$, $V_{CC} = 3.6V$

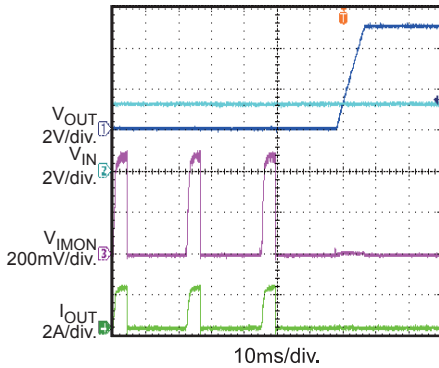

PRINTED CIRCUIT BOARD LAYOUT

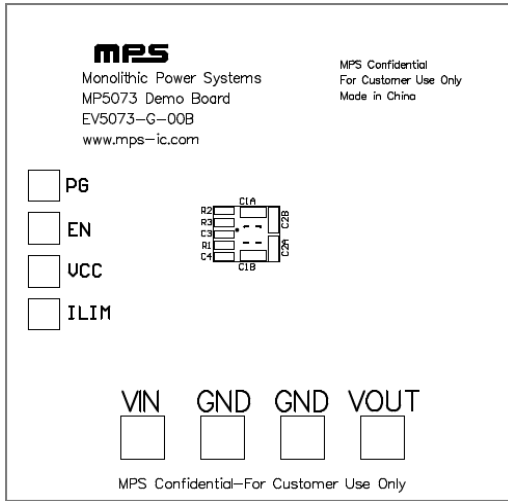

Figure1: Top Layer Silkscreen

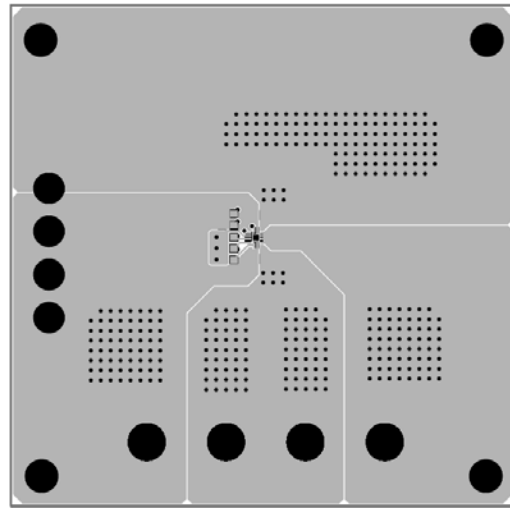

Figure2: Top Layer

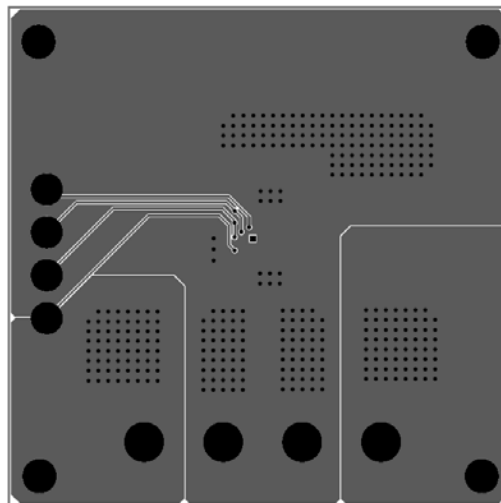

Figure3: Bottom Layer

QUICK START GUIDE

1. Connect the positive and negative terminals of the load to the VOUT and GND pins, respectively.
2. Preset the power supply output between 0.8V and 5.5V, and then turn off the power supply.
3. Connect the positive and negative terminals of the power supply output to the VIN and GND pins, respectively.
4. Follow the step 1-3 to set the Vcc voltage between 3V and 5.5V.
5. Turn the power supply on. The MP5073 will automatically startup.
6. To use the Enable function, apply a digital input to the EN pin. Drive EN higher than 2.6V to turn on the regulator or less than 0.4V to turn it off.
7. Use R1 to set the output current limit. C4 to set the SS time, Follow the Application Information section in the device datasheet to select appropriate R1, C4.

NOTICE: The information in this document is subject to change without notice. Please contact MPS for current specifications. Users should warrant and guarantee that third party Intellectual Property rights are not infringed upon when integrating MPS products into any application. MPS will not assume any legal responsibility for any said applications.