

DESCRIPTION

The MP5075 provides up to 2.4A of load protection over a 3V to 5.5V voltage range with a small R_{DS(ON)} in a space-saving package. The MP5075 is a very high-efficiency and space-saving solution for notebooks, tablets, and other portable and battery-operated applications.

With a fixed soft-start function, the MP5075 can prevent inrush current during circuit start-up. The MP5075 also provides output discharge functions, over-current protection (OCP), and thermal shutdown features.

The max load at the output (source) is current-limited. This is accomplished by utilizing sense FET topology.

An internal charge pump drives the gate of the power device, allowing for a very low on-resistance DMOS power FET of just 38mΩ.

The MP5075 is available in a space-saving SOT563(1.6mmx1.6mm)package.

ELECTRICAL SPECIFICATIONS

Parameter	Symbol	Value	Units
Continuous Operating Input Voltage	V _{IN}	3-5.5	V
Output Voltage	V _{OUT}	3-5.5	V
Output Current	I _{OUT}	2.4	A

FEATURES

- Integrated 38mΩ Low R_{DS(ON)} MOSFETs
- Wide VIN Range from 3V to 5.5V
- <5µA Shutdown Current
- Typical 3A Current Limit
- Output Discharge Function
- Internal Fixed 450µs Soft-Start Time
- <200ns Short-Circuit Protection Response Time
- Thermal Protection
- Available in a SOT563 (1.6mmx1.6mm) Package

APPLICATIONS

- Notebook and Tablet Computers
- Portable Devices
- Solid-State Drives
- Handheld Devices
- USB Power Distribution
- USB Dongles

All MPS parts are lead-free, halogen free, and adhere to the RoHS directive. For MPS green status, please visit MPS website under Quality Assurance. "MPS" and "The Future of Analog IC Technology" are Registered Trademarks of Monolithic Power Systems, Inc.

EV5075-TF-00A EVALUATION BOARD

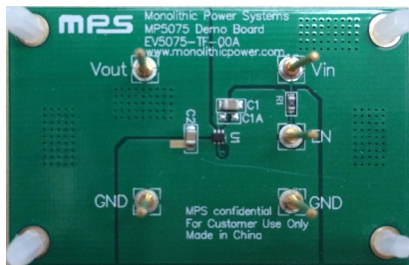

(L × W × H) 51.0mm × 33.0mm × 3mm

Board Number	MPS IC Number
EV5075-TF-00A	MP5075GTF

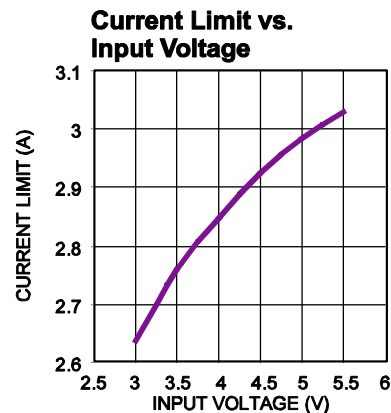

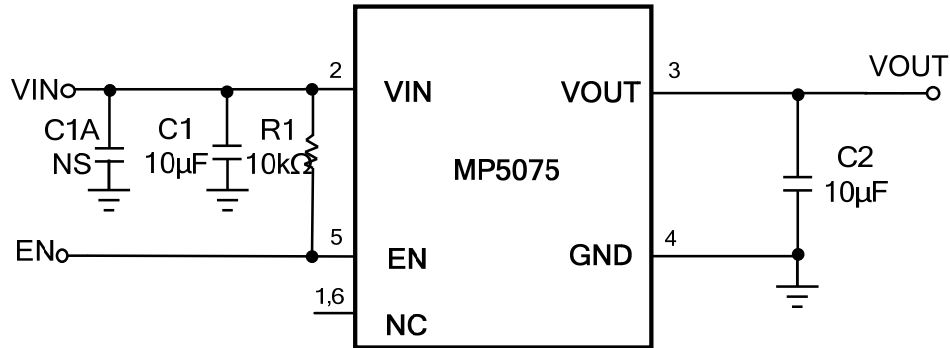
EVALUATION BOARD SCHEMATIC

EV5075-TF-00A BILL OF MATERIALS

Qty	Ref	Value	Description	Package	Manufacturer	Manufacturer P/N
2	C1,C2	10µF	Ceramic Cap, X5R, 16V	0805	Murata	GRM21BR61C106KE15L
0	C1A	NS		0805		
1	R1	10KΩ	Film Res, 1%	0603	ROYAL	RL0603FR-0710KL
1	U1		Load Switch	SOT563	MPS	MP5075GTF

EVB TEST RESULTS

Performance waveforms are tested on the evaluation board.

$V_{IN} = V_{EN} = 5V$, $T_A = 25^\circ C$, unless otherwise noted.

Quiescent Current vs. Input Voltage

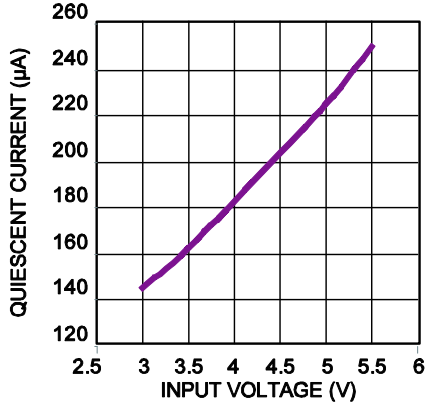

Shutdown Current vs. Input Voltage

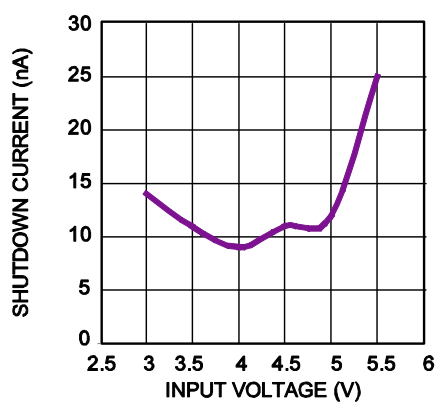

VIN UVLO Rising Threshold vs. Temperature

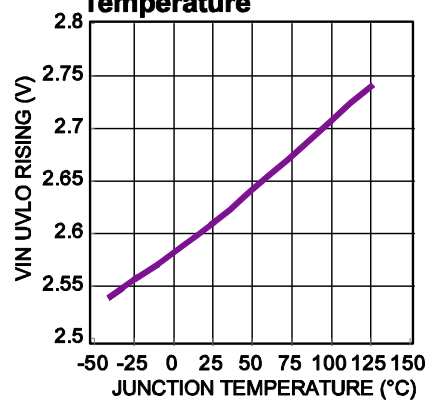

Vin UVLO Falling Threshold vs. Temperature

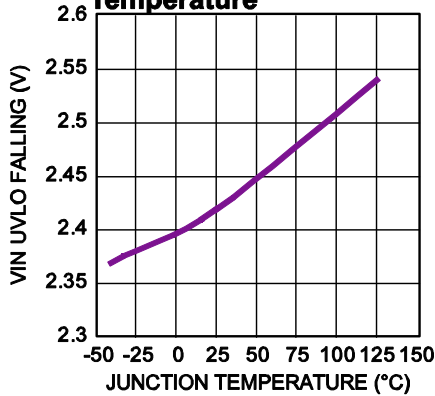

En Rising Threshold vs. Temperature

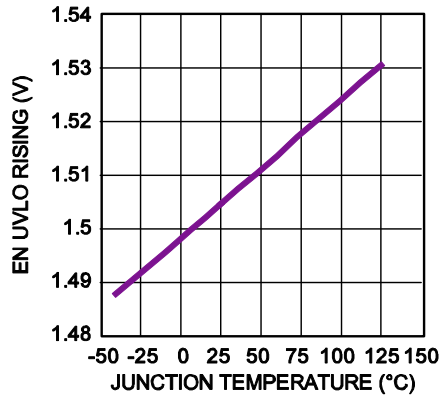

En Falling Threshold vs. Temperature

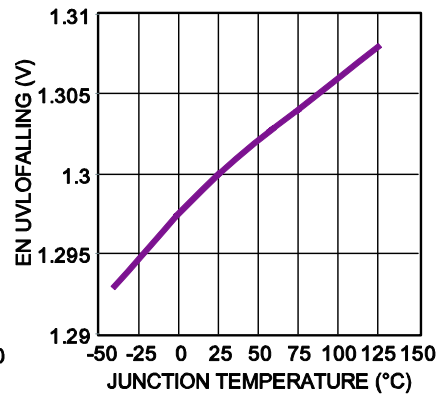

Current Limit vs. Input Voltage

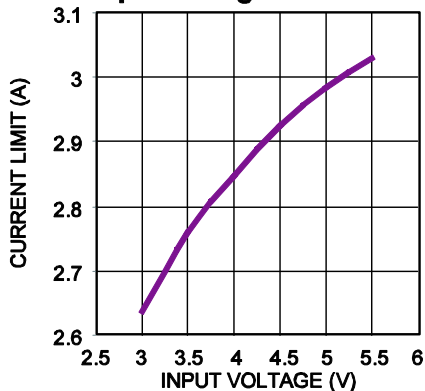

$R_{ds(On)}$ vs. Input Voltage

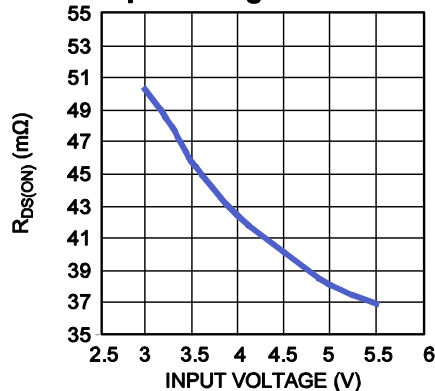

EVB TEST RESULTS (continued)

Performance waveforms are tested on the evaluation board.

$V_{IN} = V_{EN} = 5V$, $T_A = 25^\circ C$, unless otherwise noted.

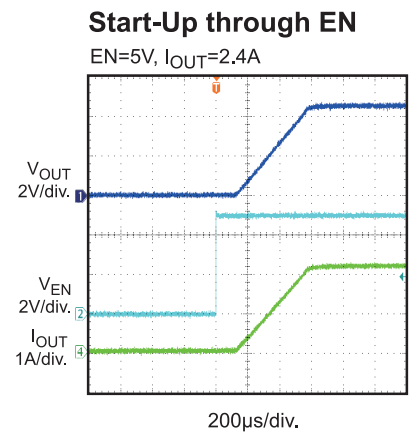
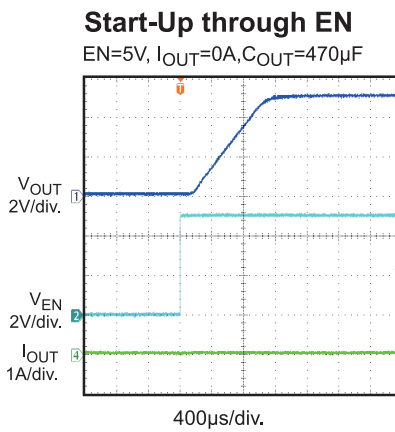
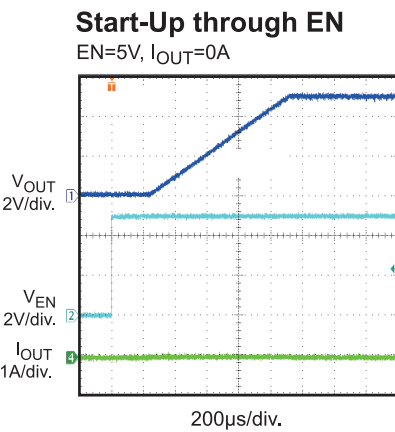
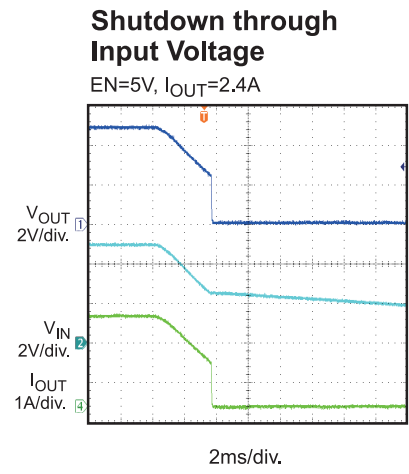
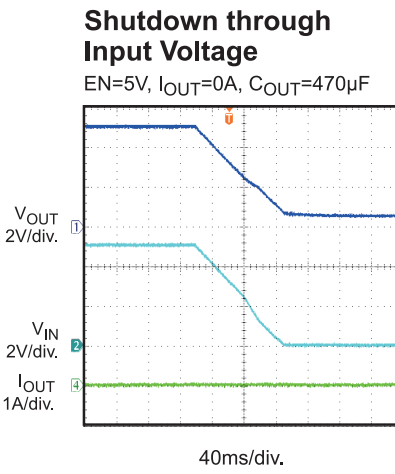
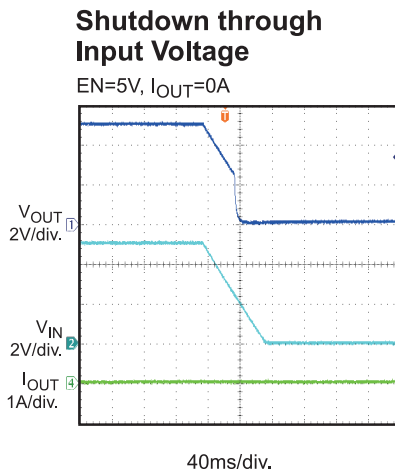
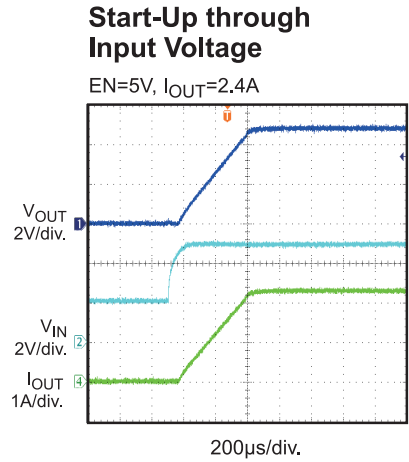
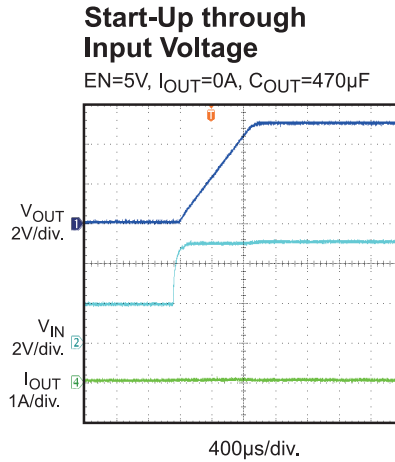
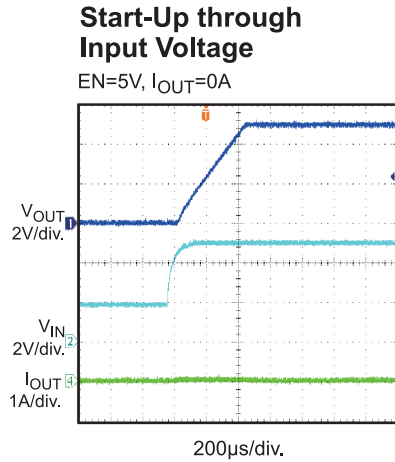

EVB TEST RESULTS (continued)

Performance waveforms are tested on the evaluation board.

$V_{IN} = V_{EN} = 5V$, $T_A = 25^\circ C$, unless otherwise noted.

Shutdown through EN

$V_{IN}=5V, I_{OUT}=0A$

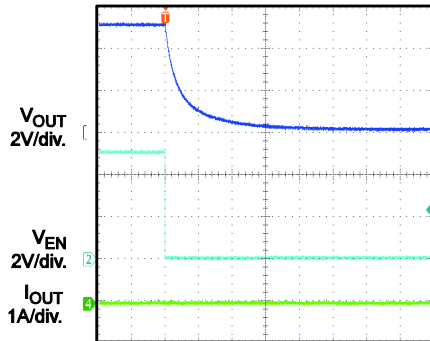

2ms/div.

Shutdown through EN

$V_{IN}=5V, I_{OUT}=0A, C_{OUT}=470\mu F$

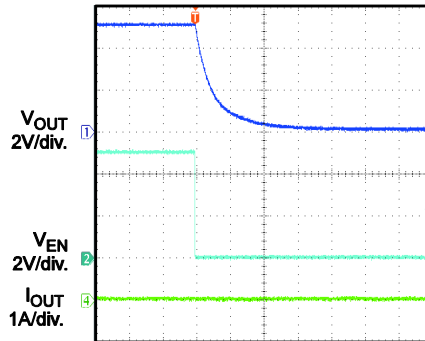

100ms/div.

Shutdown through EN

$V_{IN}=5V, I_{OUT}=2.4A$

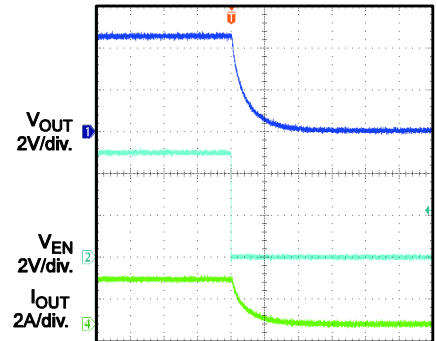

40μs/div.

OCP Current Limit with Resistive Load

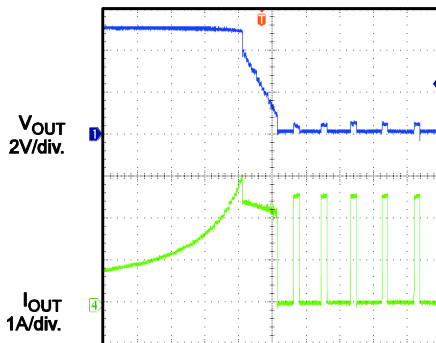

20ms/div.

SCP Entry

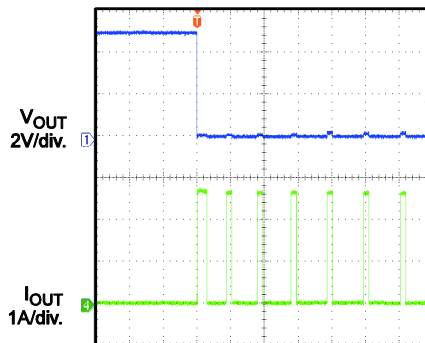

20ms/div.

SCP Recovery

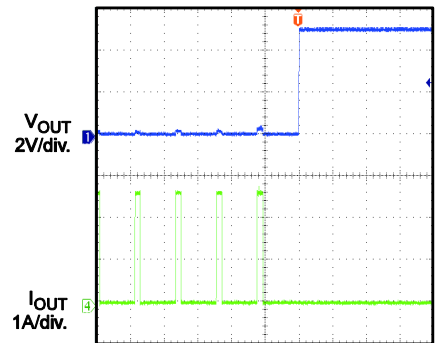

20ms/div.

PRINTED CIRCUIT BOARD LAYOUT



Monolithic Power Systems
 MP5075 Demo Board
 EV5075-TF-00A
 www.monolithicpower.com

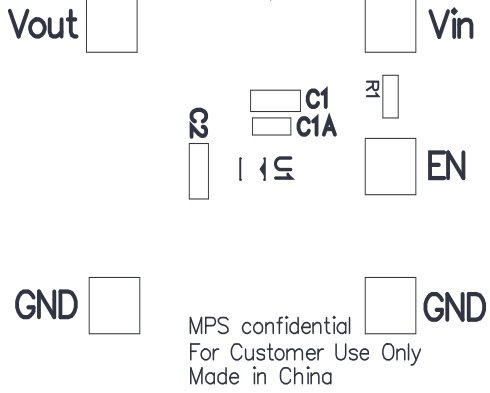

Figure 1—Top Silk Layer

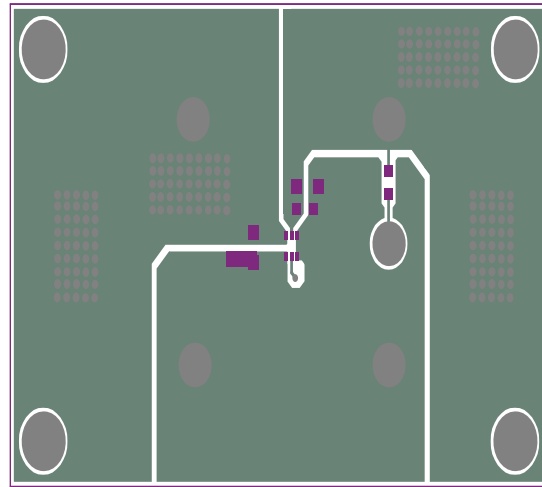

Figure 2—Top Layer

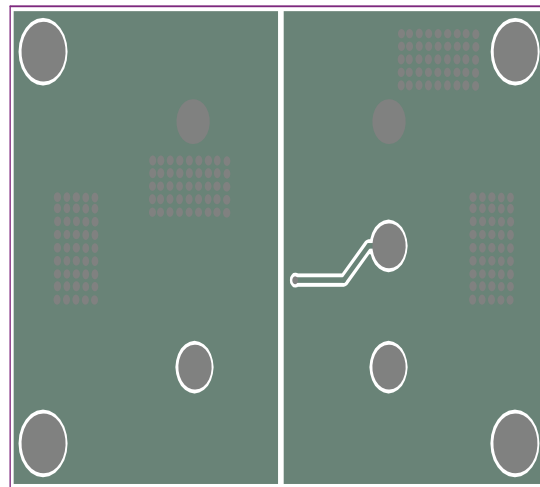

Figure 2—Bottom Layer

QUICK START GUIDE

1. Place an input capacitor close to VIN.
2. Connect NC to GND for an easier layout.
3. Place enough vias around the IC and enough copper area near VIN and VOUT to achieve better thermal performance.

NOTICE: The information in this document is subject to change without notice. Users should warrant and guarantee that third party Intellectual Property rights are not infringed upon when integrating MPS products into any application. MPS will not assume any legal responsibility for any said applications.