

PRELIMINARY SPECIFICATIONS SUBJECT TO CHANGE

DESCRIPTION

The EV5095-J-00A is an evaluation board for the MP5095, a low IQ dual channel load switch.

The MP5095 integrated a dual load switches to provide load protection covering 0.5V to 5.5V voltage range. Each channel provides up to 2.5A load protection covering 0.5V to 5.5V voltage range with 1.85V V_{CC} power supply. With the small $R_{DS(on)}$ in tiny package, MP5095 provide very high efficient and space saving solution in notebook and tablet or other portable devices application.

With the internal soft start function, the MP5095 can avoid inrush current during circuit start up. MP5095 also provides internal current limit, hiccup protection and thermal shutdown features. MP5095 also easily parallel both channels to double current capability.

The EV board can deliver a continuous 2.5A load current in each channel and over 0.5V to 5.5V operating input range.

ELECTRICAL SPECIFICATION

Parameter	Symbol	Value	Units
Input Voltage ⁽¹⁾	$V_{IN1/2}$	0.5-5.5	V
Vcc Voltage	V_{CC}	1.85-5.5	V
Output Current	I_{OUT}	2.5/2.5	A

Note:

1) For specifications of lower voltage, please contact factory.

FEATURES

- Integrated 30mΩ Low $R_{DS(on)}$ FETs
- Low Quiescent Current: 40μA
- Wide VIN Range from 0.5V to 5.5V
- <1μA Shutdown Current
- Output Discharge Function
- Continuous Current Capability 2.5A
- Enable Pin
- Short-Circuit Response Protection
- Easily Parallel Connect Dual Channel
- Support Reverse Block Connection
- Thermal Protection
- Available in a TSOT23-8 Package

APPLICATIONS

- Notebook and Tablet Computers
- Portable Devices
- Solid State Drives
- Handheld Devices

All MPS parts are lead-free, halogen free, and adhere to the RoHS directive. For MPS green status, please visit MPS website under Quality Assurance. "MPS" and "The Future of Analog IC Technology" are Registered Trademarks of Monolithic Power Systems, Inc.

EV5095-J-00A EVALUATION BOARD



(L x W x H) 6.4cm x 6.4cm x 1.3cm

Board Number	MPS IC Number
EV5095-J-00A	MP5095GJ

$R_{DS(on)}$ vs. V_{CC}

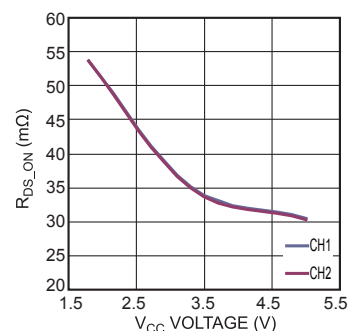

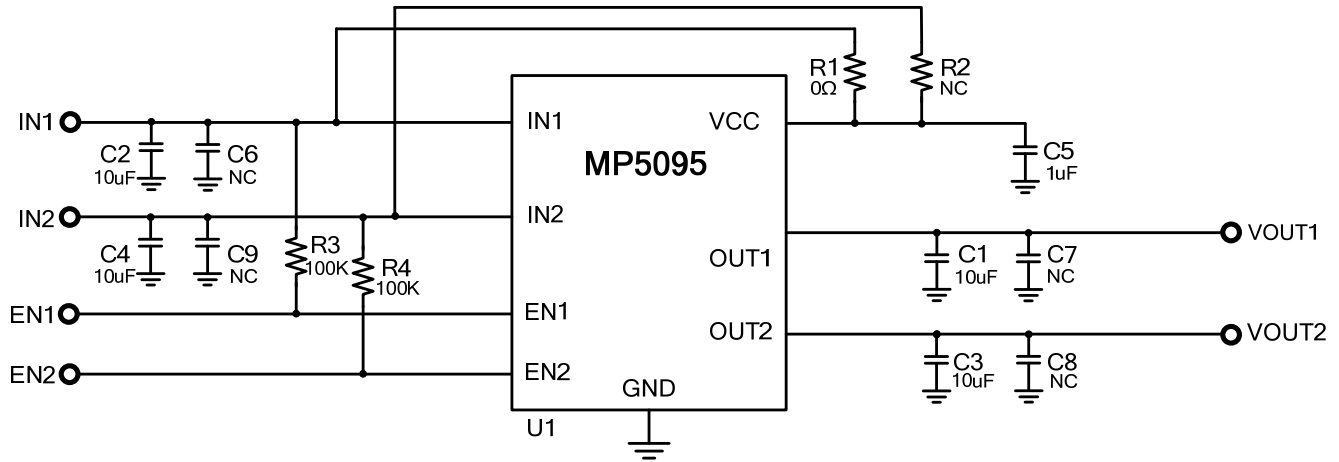
EVALUATION BOARD SCHEMATIC

EV5095-J-00A BILL OF MATERIALS

Qty	Ref	Value	Description	Package	Manufacturer	Manufacturer P/N
4	C2, C4, C1, C3	10μF	Ceramic Cap,6.3V,X5R	0603	muRata	GRM188R60J106ME47D
1	C5	1μF	Ceramic Cap,6.3V,X5R	0603	muRata	GRM188R60J105KA01D
1	U1	MP5095	Dual Channel Switch		MPS	MP5095GJ
1	R1	0Ω	Film Res,1%,0603,0R	0603	YAGEO	RC0603JR-070RL
2	R3, R4	100kΩ	Film Res,1%,0603,100K	0603	YAGEO	RC0603FR-07100KL
0	R2	NC				
0	C6,C9, C7,C8	NC				

EVB TEST RESULTS

Performance waveforms are tested on the evaluation board.

$V_{IN} = 3.6V$, $V_{CC} = 3.6V$, $T_A = 25^{\circ}C$, unless otherwise noted.

R_{DS_ON} vs. V_{CC}

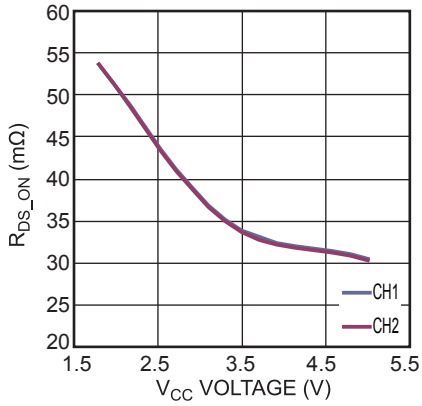

EN Rising Threshold

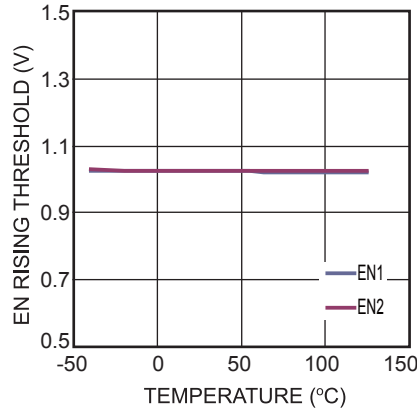

EN Falling Threshold

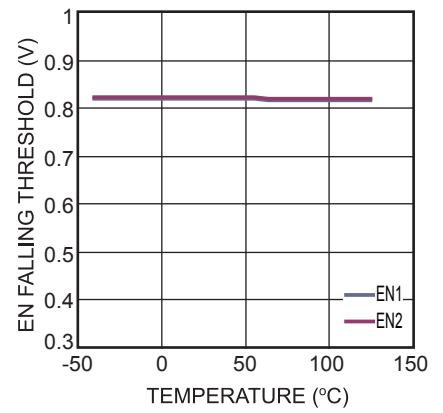

V_{CC} Rising Threshold

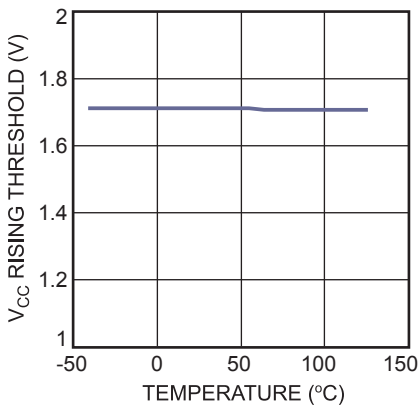

V_{CC} Falling Threshold

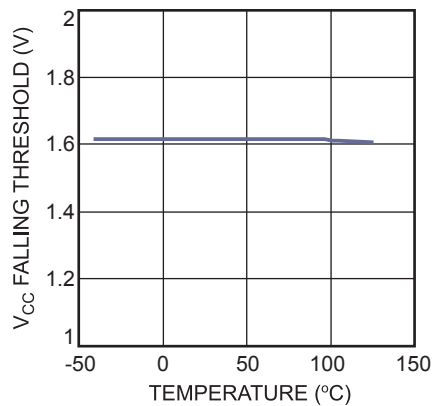

EVB Test Results (CONTINUED)

Performance waveforms are tested on the evaluation board.

 $V_{IN} = 3.6V$, $V_{CC} = 3.6V$, $T_A = 25^\circ C$, unless otherwise noted.

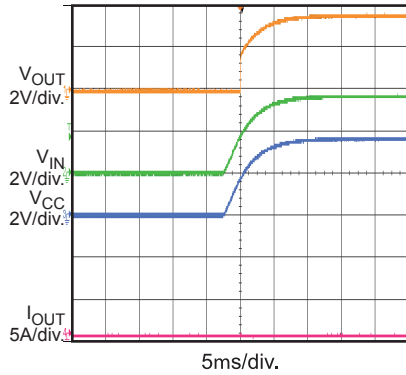
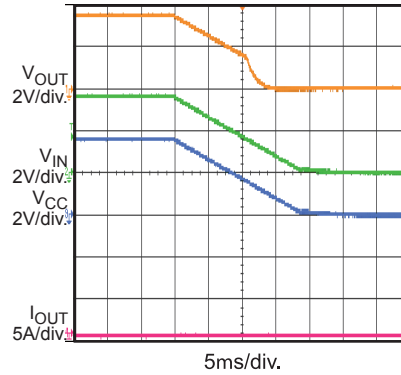
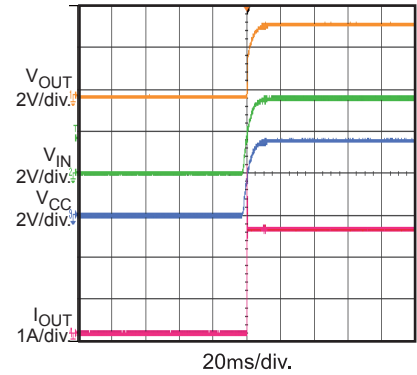
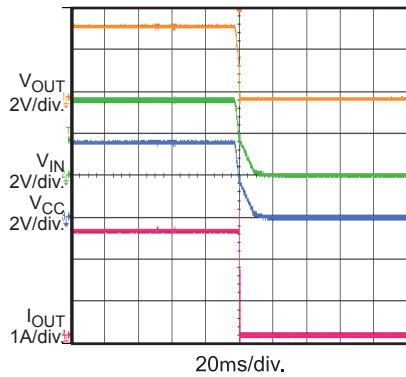
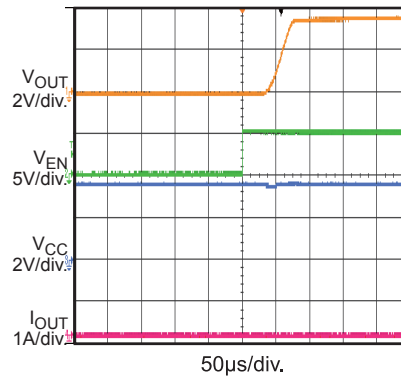
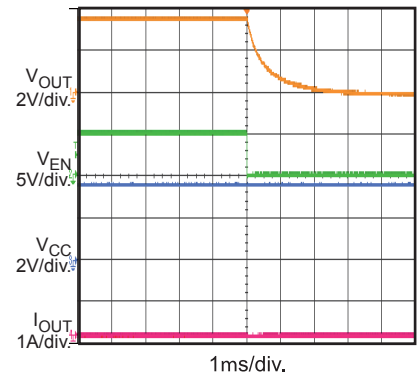
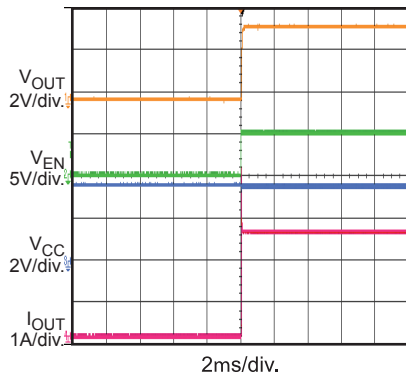
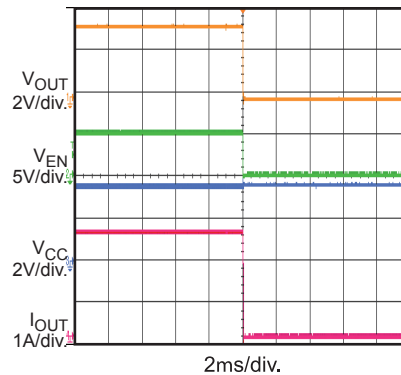
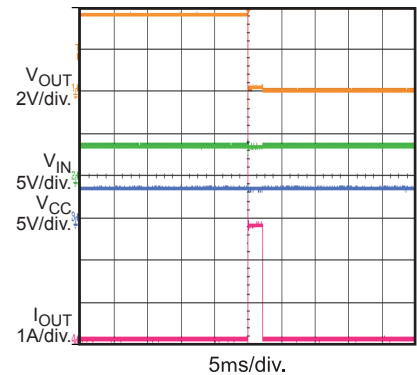
 V_{IN} Start-Up
with No Load

 V_{IN} Shutdown
with No Load

 V_{IN} Start-Up
with 2.5A Load

 V_{IN} Shutdown
with 2.5A Load

EN Start-Up
with No Load

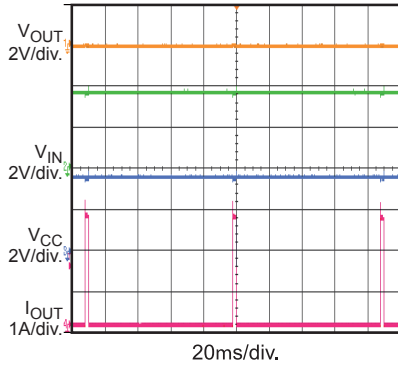
EN Shutdown
with No Load

EN Start-Up
with 2.5A Load

EN Shutdown
with 2.5A Load

Short Enter

EVB TEST RESULTS (continued)

Performance waveforms are tested on the evaluation board.

$V_{IN} = 3.6V$, $V_{CC} = 3.6V$, $T_A = 25^{\circ}C$, unless otherwise noted.

Short Steady State



Short Recovery

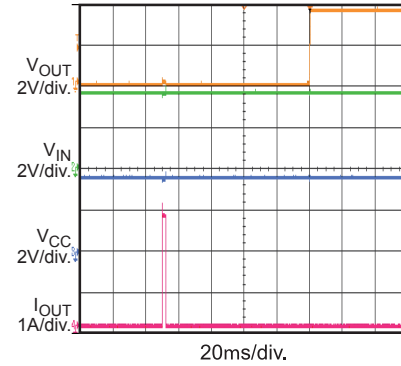

V_{IN} Start-Up with Short

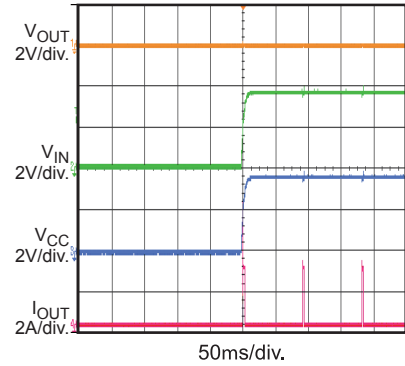

V_{IN} Shutdown with Short

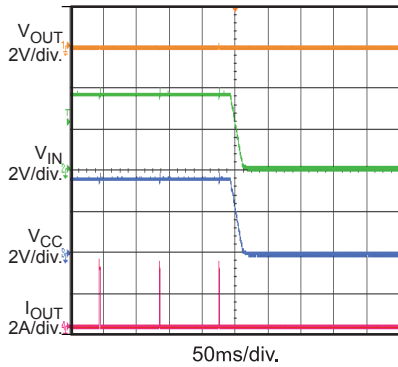

EN Start-Up with Short

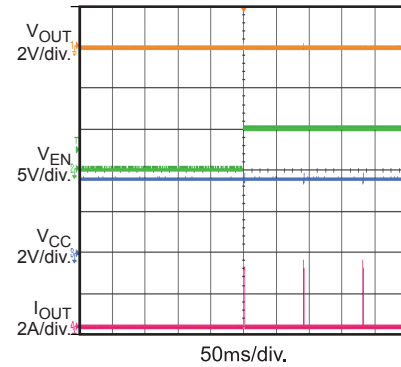

EN Shutdown with Short

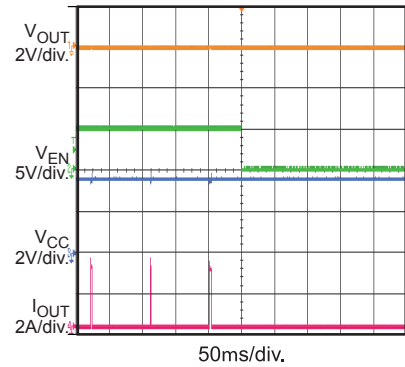

Short Enter (Parallel)

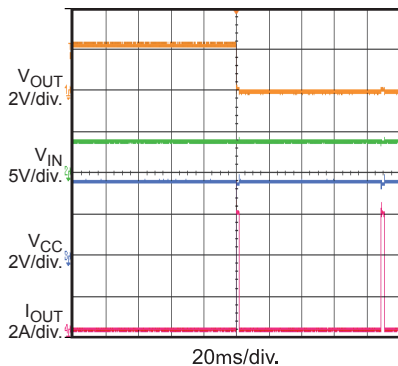

Short Steady (Parallel)

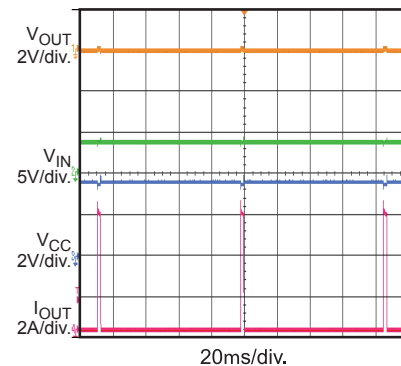

Short Recovery (Parallel)

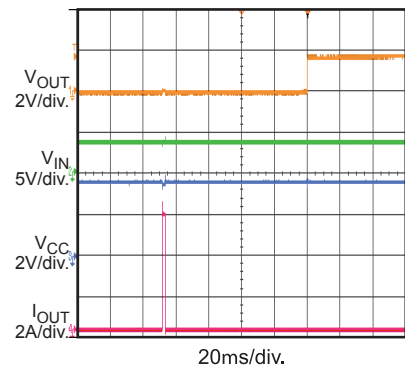

PRINTED CIRCUIT BOARD LAYOUT

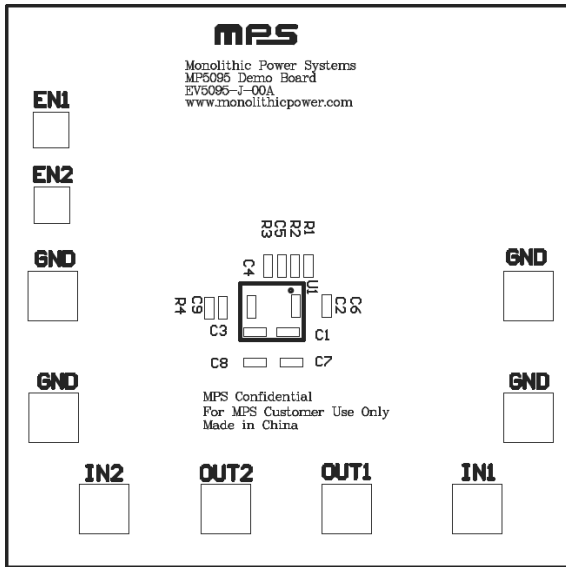

Figure1: Top Layer Silkscreen

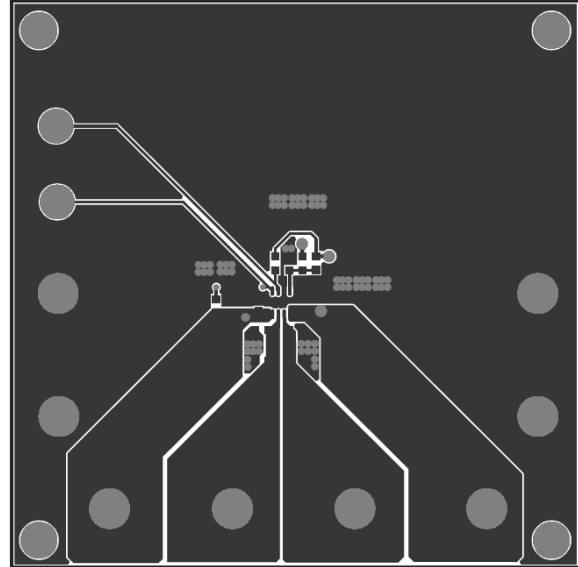

Figure2: Top Layer

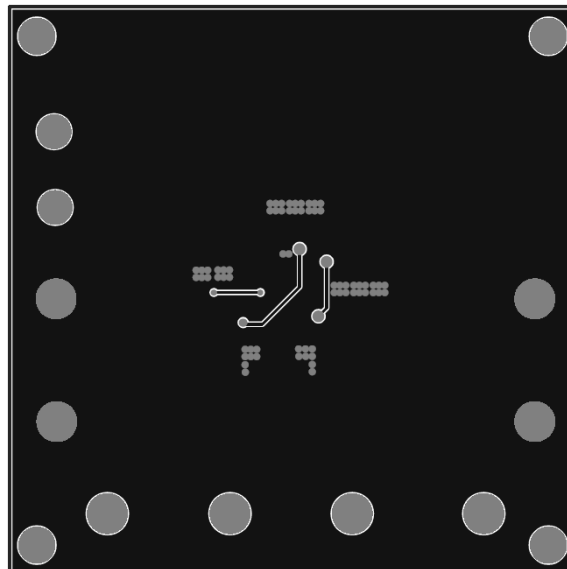

Figure3: Bottom Layer

QUICK START GUIDE

Easy Start:

1. Connect the positive and negative terminals of the load to the V_{OUT1} , V_{OUT2} and GND pins, respectively.
2. Preset the power supply output between 1.85V and 5.5V, and then turn off the power supply.
3. Connect the positive and negative terminals of the power supply output to the V_{IN1} and GND pins, respectively.
4. Follow the step 2-3 to set the V_{IN2} voltage between 1.85V and 5.5V too.
5. Turn the power supplies on. The MP5095 will automatically startup.

EN and Vcc Usage:

1. To use the Enable function, apply a digital input to the $EN_{1/2}$ pin. Drive EN higher than 1V to turn on the regulator or less than 0.8V to turn it off.
2. Remove R1, R2 and apply a voltage what's higher than 1.85V on Vcc independently for the situation that Vin voltage is different with Vcc voltage or Vin is $0.5V < V_{in} < 1.85V$.

NOTICE: The information in this document is subject to change without notice. Please contact MPS for current specifications. Users should warrant and guarantee that third party Intellectual Property rights are not infringed upon when integrating MPS products into any application. MPS will not assume any legal responsibility for any said applications.