

DESCRIPTION

The MP5408 integrates a monolithic step-down switch-mode converter with two USB current-limit switches and charging port identification circuitry for each port. It achieves 6A output current over a wide input-supply range with excellent load and line regulation.

The output of the USB switch is current limited. Both USB ports support DCP schemes for Battery Charging specification (BC1.2), the Divider Mode, 1.2V/1.2V Mode and USB TYPE-C 5V@3A DFP Mode eliminating outside user interaction.

ELECTRICAL SPECIFICATION

Parameter	Symbol	Value	Units
Operating Input Voltage	V_{IN}	12	V
Switching Frequency	F_s	235	kHz
Output Voltage	V_{USB1}/V_{USB2}	5.17	V
Output Current	USB1_ I_{OUT}	3	A
	USB2_ I_{OUT}	3	A

FEATURES

- Wide 6V to 36V Operating Input-Voltage Range
- Selectable Output Voltage: 5.1V, 5.17V and 5.3V
- 90mV Line Drop Compensation
- Accurate USB1/USB2 Output-Current Limit
- 18m Ω /15m Ω Low $R_{DS(ON)}$ Internal Buck Power MOSFETs
- 13m Ω /13m Ω Low $R_{DS(ON)}$ Internal USB1/USB2 Power MOSFETs
- Load Shedding versus Temperature
- Hiccup Current Limit for both Buck and USB
- Supports DCP schemes for BC1.2, Divider Mode, and 1.2V/1.2V Mode
- Supports USB TYPE-C 5V@3A Mode

APPLICATIONS

- USB Dedicated Charging Ports (DCP)
- Automotive Cigarette Lighter Adapters
- Power Supply for Linear Chargers

All MPS parts are lead-free, halogen free, and adhere to the RoHS directive. For MPS green status, please visit MPS website under Quality Assurance.

"MPS" and "The Future of Analog IC Technology" are Registered Trademarks of Monolithic Power Systems, Inc.

EV5408-U-00A EVALUATION BOARD

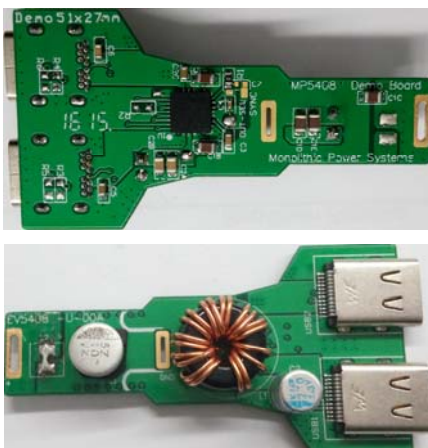

(L x W x H) 5.1cm x 2.7cm x 1.7cm
(Four Layer PCB/2oz per layer)

Board Number	MPS IC Number
EV5408-U-00A	MP5408

Efficiency vs. Load Current

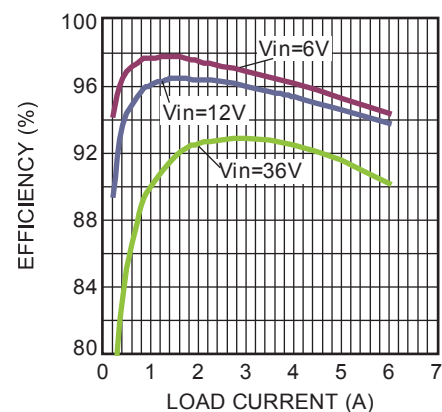

EVALUATION BOARD SCHEMATIC

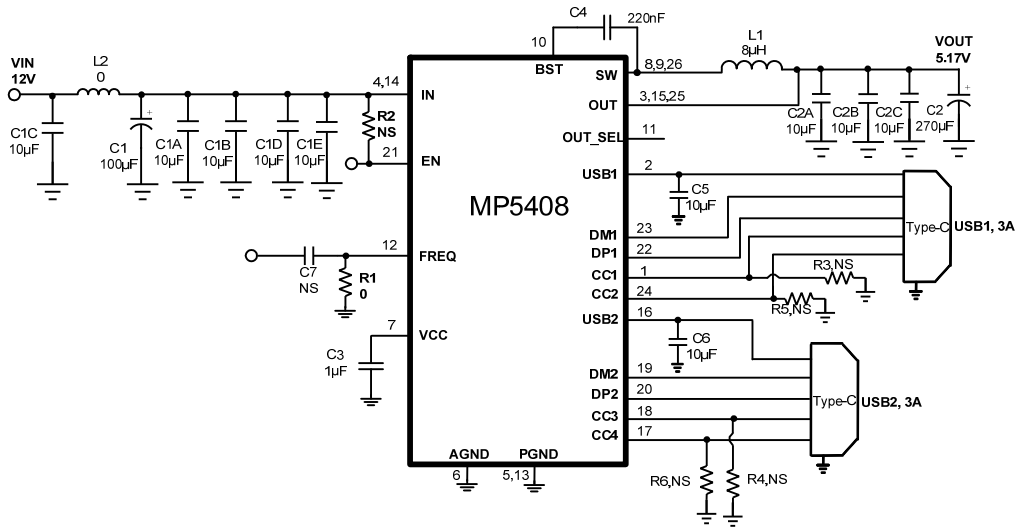

EV5408-U-00A BILL OF MATERIALS

Qty	Ref	Value	Description	Package	Manufacturer	Part Number
5	C1A, C1B, C1C,C1D, C1E	10 μ F	Ceramic Capacitor, 35V, X5R	0805	Murata	GRM21BR61E106KA43L
1	C1	100 μ F	Aluminum Electrolytic Capacitor, 35V, 160m Ω ESR	SMT	Chemi-Con	EMZJ35ADA101MF80G
1	C2	270 μ F	Polymer Capacitor,6.3V	DIP	Chemi-Con	APSK6R3ELL271ME08S
2	C2A, C2B	10 μ F	Ceramic Capacitor, 10V, X7R	0805	Murata	GRM21BR71A106KE51L
1	C2C	10 μ F	Ceramic Capacitor, 6.3V, X7R	0603	Murata	GRM219R60J106KE19D
1	C3	1 μ F	Ceramic Capacitor, 16V, X7R	0603	Murata	GRM188R71C105KA12D
1	C4	0.22 μ F	Ceramic Capacitor, 10V, X5R	0402	Murata	GRM155R61A224KE19
2	C5, C6	10 μ F	Ceramic Capacitor, 6.3V, X7R	0603	Murata	GRM219R60J106KE19D
0	C7, R2,R3,R4, R5,R6	NS				
1	R1	0	Film Resistor, 1%	0603	Royal	RL0603FR-070RL
1	L1	8 μ H	Toroidal Inductor, DCR 8m Ω	DIP	UEC (威盛科)	WL-824
2	USB1, USB2	USB	TYPE-C USB Port	DIP	Wurth	632723300011
1	U1	MP5408	Step Down Converter with Dual USB Charging Port	QFN26 (5mmx5mm)	MPS	MP5408GU

TYPICAL PERFORMANCE CHARACTERISTICS

$V_{IN} = 12V$, $V_{OUT} = 5.17V$, $L = 8\mu H$, $T_A = 25^\circ C$, unless otherwise noted.

Output Ripple

$V_{IN}=12V$, $V_{OUT}=5.17V$,
 $USB1_I_{OUT}=USB2_I_{OUT}=0A$

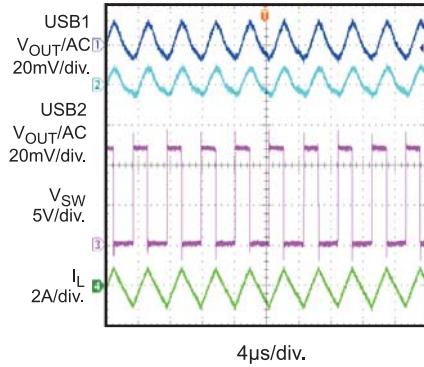

Output Ripple

$V_{IN}=12V$, $V_{OUT}=5.17V$,
 $USB1_I_{OUT}=USB2_I_{OUT}=3A$

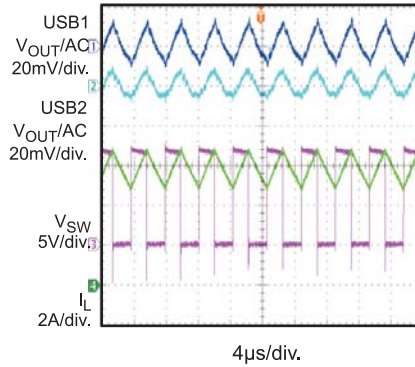

Power Start-up

$V_{IN}=12V$, $V_{OUT}=5.17V$,
 $USB1_I_{OUT}=USB2_I_{OUT}=0A$

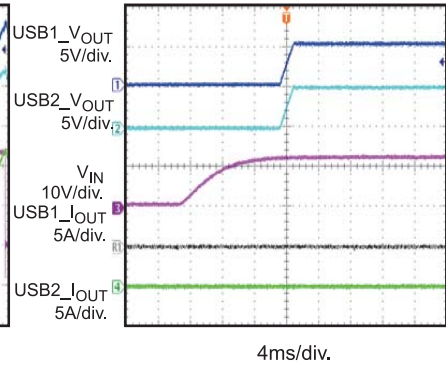

Power Start-up

$V_{IN}=12V$, $V_{OUT}=5.17V$,
 $USB1_I_{OUT}=USB2_I_{OUT}=3A$

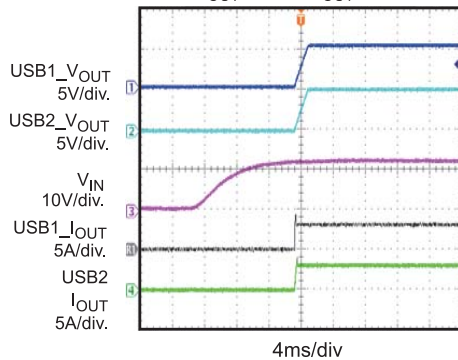

Power Shutdown

$V_{IN}=12V$, $V_{OUT}=5.17V$,
 $USB1_I_{OUT}=USB2_I_{OUT}=0A$

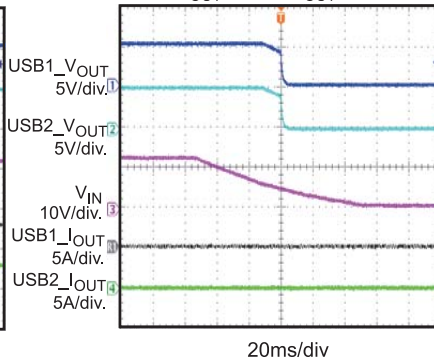

Power Shutdown

$V_{IN}=12V$, $V_{OUT}=5.17V$,
 $USB1_I_{OUT}=USB2_I_{OUT}=3A$

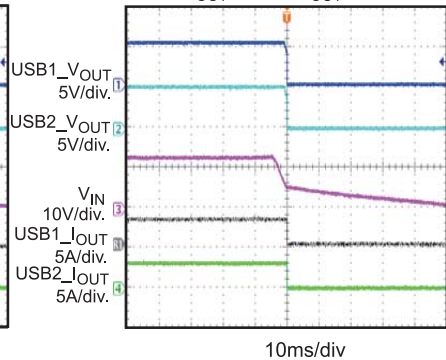

USB Over-Current Protection

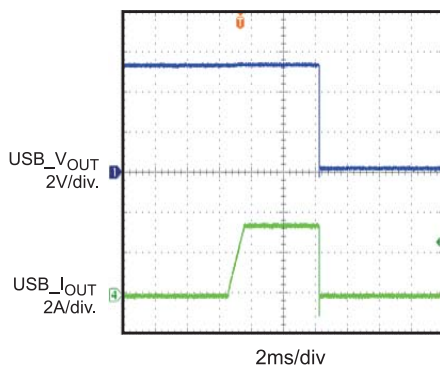

Load Shedding Entry

$V_{IN}=12V$, $V_{OUT}=5.17V$

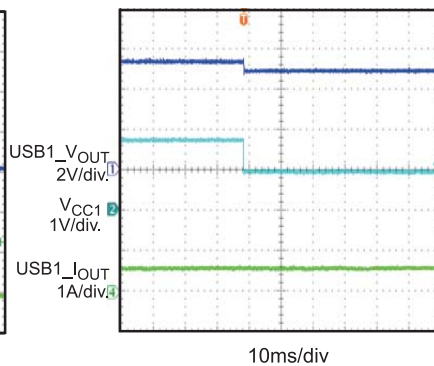

Load Shedding Recovery

$V_{IN}=12V$, $V_{OUT}=5.17V$

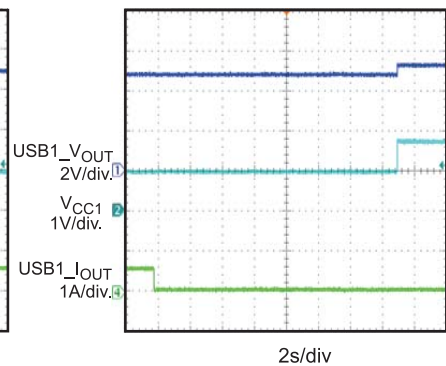

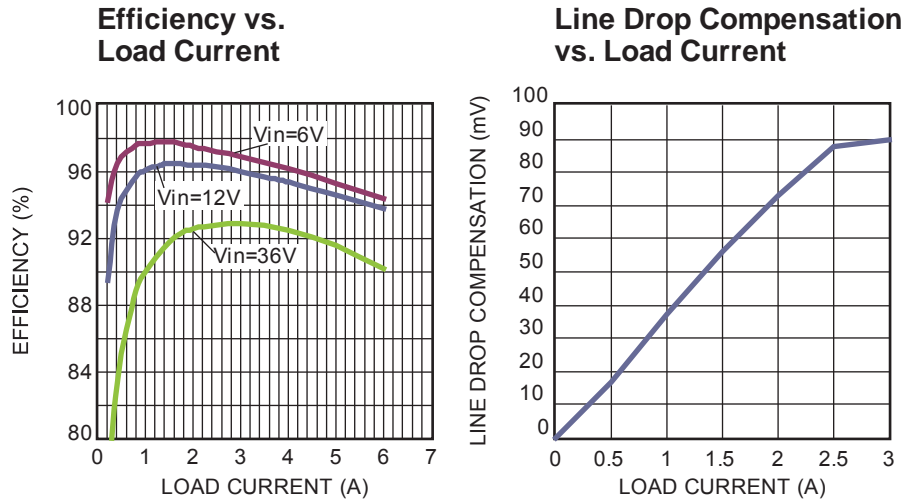
TYPICAL PERFORMANCE CHARACTERISTICS (continued)
 $V_{IN} = 12V$, $V_{OUT} = 5.17V$, $L = 8\mu H$, $T_A = 25^\circ C$, unless otherwise noted.

PRINTED CIRCUIT BOARD LAYOUT

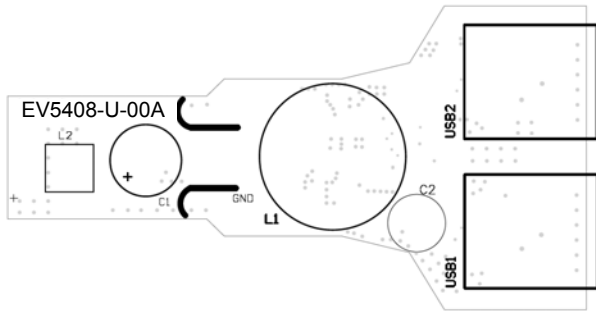

Figure 1—Top Silk Layer

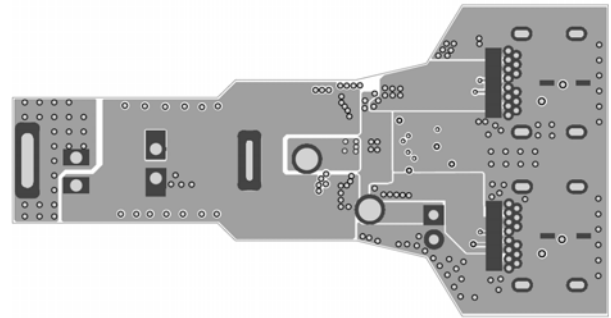

Figure 2—Top Layer

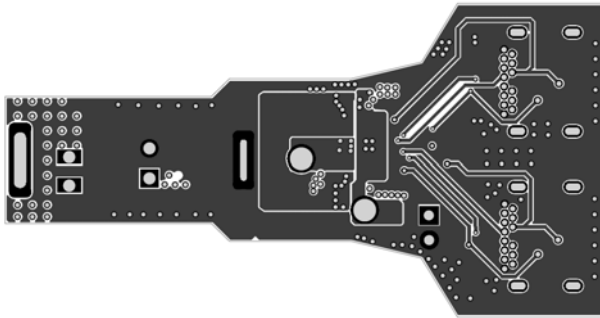

Figure 3—Middle1 Layer

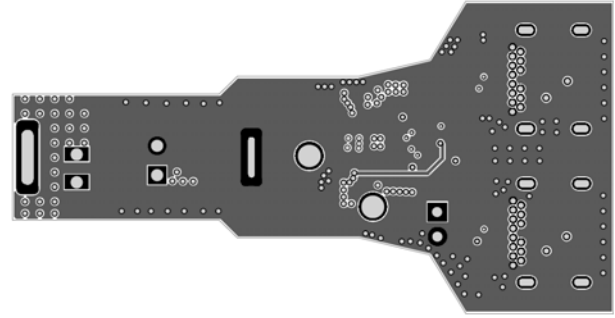

Figure 4—Middle 2 Layer



Figure 5—Bottom Silk Layer

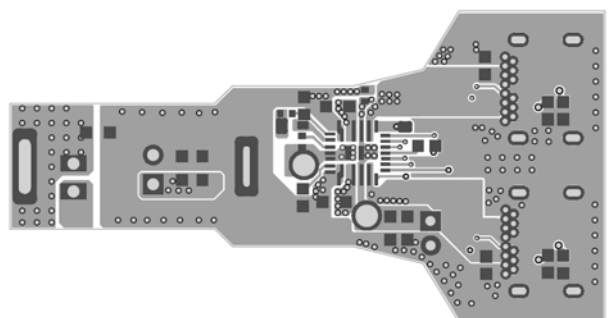

Figure 6—Bottom Layer

QUICK START GUIDE

1. Connect the positive and negative terminals of the load to the USB1, USB2 and GND pins, respectively.
2. Preset the power supply output between 6V and 36V, and then turn off the power supply.
3. Connect the positive and negative terminals of the power supply output to the VIN and GND pins, respectively.
4. Turn the power supply on, the board will automatically start up. But if no type-C device is attached, there is no Vbus output.
5. For USB Type-C 5V/3A DFP mode, if no type-C device is attached, connect R3 =5.1k Ω resistor to enable USB1output, connect R4 =5.1k Ω to enable USB2 output; Connect R5 =1k Ω resistor to enable VCONN1 output, connect R6=1k Ω resistor to enable VCONN2 output.
6. For USB Type-A 5V/2.4A mode, connect R3 =80.6k Ω resistor to enable USB1output, connect R4 =80.6k Ω resistor to enable USB2 output. Keep R5, R6 float.

NOTICE: The information in this document is subject to change without notice. Please contact MPS for current specifications. Users should warrant and guarantee that third party Intellectual Property rights are not infringed upon when integrating MPS products into any application. MPS will not assume any legal responsibility for any said applications.