

GENERAL DESCRIPTION

The EV6003-N-00A is an evaluation board for the MP6003, a monolithic Flyback/Forward DC-DC converter. The device integrates a 150V power switch and is capable of delivering up to 5W output power. The MP6003 has an internal soft-start, auto-retry, and incorporates over current, short circuit, and over-voltage protection. It can also skip cycles to maintain zero load regulation.

This device is available in an 8-pin SOIC package with an exposed pad.

ELECTRICAL SPECIFICATIONS

Parameter	Symbol	Value	Units
Input Voltage	V_{IN}	24-120	V
Output Voltage	V_{OUT}	5	V
Output Current	I_{OUT}	0.8	A

FEATURES

- Integrated 150V Power Switch
- Integrated 100V Startup Circuit
- Cycle-by-Cycle Current Limiting
- Duty Cycle Limiting with Line Feed Forward
- Input UVLO + Over Voltage Protection
- Thermal Shutdown

APPLICATIONS

- Telecom Equipment
- VoIP Phones, Power over Ethernet (PoE)
- Distributed Power Conversions

All MPS parts are lead-free and adhere to the RoHS directive. For MPS green status, please visit MPS website under Products, Quality Assurance page.

"MPS" and "The Future of Analog IC Technology" are Trademarks of Monolithic Power Systems, Inc.

EV6003-N-00A EVALUATION BOARD

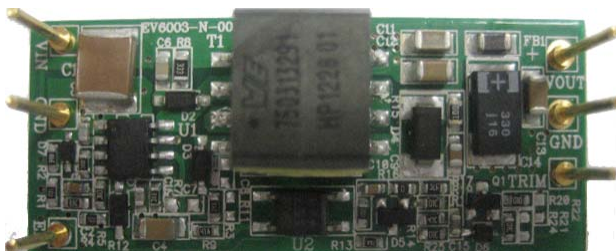

(L x W x H) 2.4" x 0.9" x 0.5"
(6.0cm x 2.3cm x 1.2cm)

Board Number	MPS IC Number
EV6003-N-00A	MP6003-N

Efficiency vs Load Current

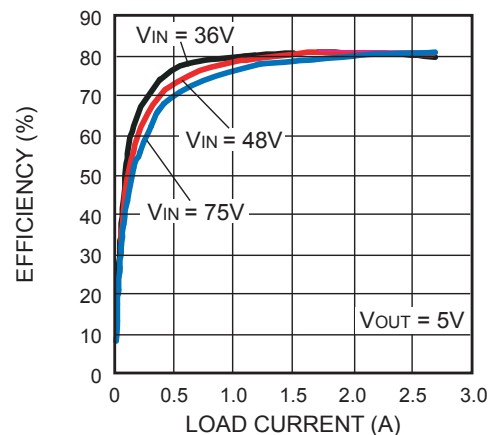

MP6001-EC01

EVALUATION BOARD SCHEMATIC

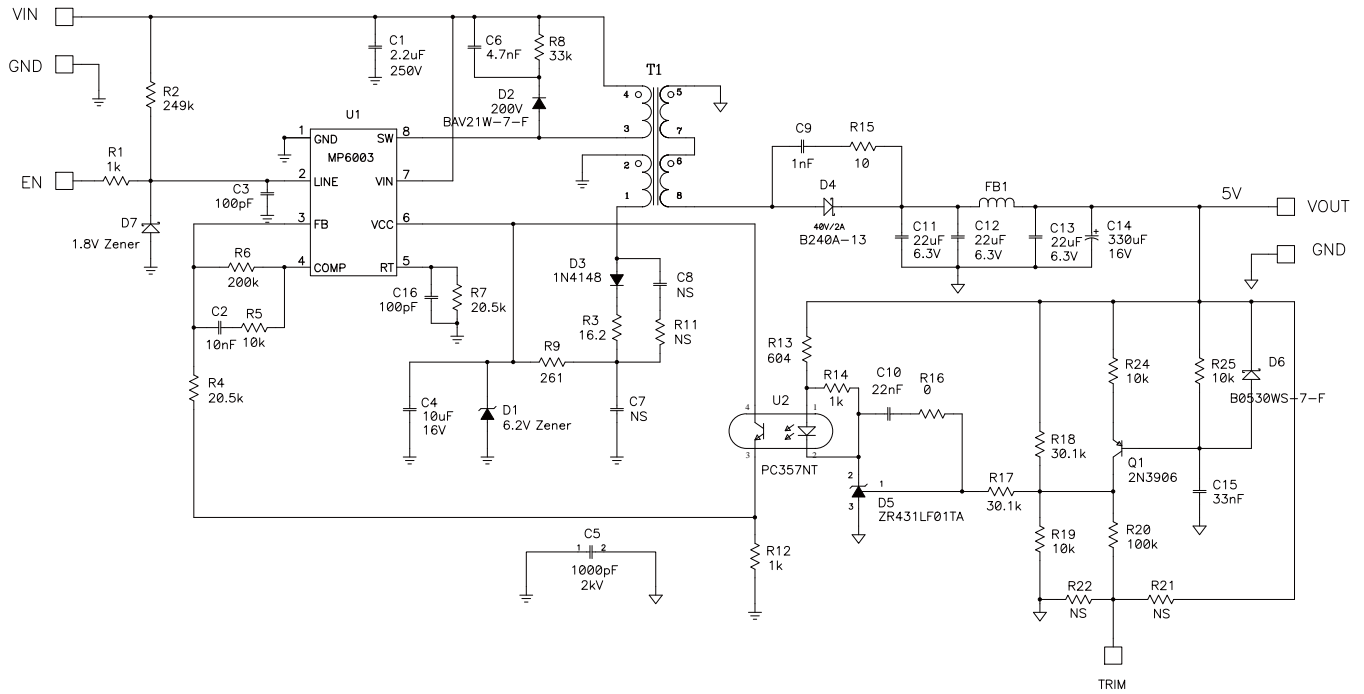

EV6003-N-00A BILL OF MATERIALS

Qty	Ref	Value	Description	Package	Manufacturer	Part Number
1	C1	2.2μF	Ceramic Cap, 250V, X7T	2220	TDK	CGA9P3X7T2E225M
1	C2	10nF	Ceramic Cap, 50V, X7R, 10%	603	muRata	GRM188R71H103KA01D
2	C3,C16	100pF	Ceramic Cap, 50V, NPO, 5%	603	muRata	GRM1885C1H101JA01D
1	C4	10μF	Ceramic Cap, 16V, X7R, 10%	1206	muRata	GCM31CR71C106KA64L
1	C5	1000pF	Ceramic Cap, 2kV, X7R	1808	TDK	C4520X7R3D102K
1	C6	4.7nF	Ceramic Cap, 250V, X7R, 10%	805	muRata	GRM21AR72E472KW01D
	C7,C8	NS	No Stuff			
1	C9	1nF	Ceramic Cap, 50V, X7R, 10%	805	muRata	GRM216R71H102KA01D
1	C10	22nF	Ceramic Cap, 50V, X7R	603	muRata	GRM188R71H223KA01D
3	C11, C12, C13	22μF	Ceramic Cap, 6.3V, X5R	1206	muRata	GRM31CR60J226KE19L
1	C14	330μF	PosCap, 6.3V	SMD	Sanyo	6TPE330MIL
1	C15	33nF	Ceramic Cap, 50V, X7R, 10%	603	muRata	GRM188R71H333KA61D
1	D1		Diode Zener, 6.2V, 500mW	SOD-123	Diodes Inc	BZT52C6V2-7-F
1	D2		Diode Switch, 200V, 250mW	SOD-123	Diodes Inc	BAV21W-7-F
1	D3		Diode Switch, 75V, 200mW	SOD-123	Diodes Inc	1N4148WS-7-F
1	D4		Diode Schottky, 40V, 2A	SMA	Diodes Inc	B240A-13-F
1	D5		Voltage Regulator, 1.24V	SOT-23	Zetex Inc	ZR431LF01TA
1	D6		Diode Schottky, 30V, 500mA	SOD-323	Diodes Inc	B0530WS-7-F
1	D7		Diode Zener, 1.8V, 250mW	SOD-323	Central Semi	CMSZ1L8
1	FB1		Ferrite Bead, 6A, 50 Ohm	1206	Steward	HI1206T500R-00
1	Q1		Transistor, PNP, 40V, 400mW	SOT-23	Fairchild	MMBT3906
3	R1, R12, R14	1k	Film Res, 5%	603	Yageo	RC0603JR-071KL
1	R2	249k	Film Res, 1%	603	Yageo	RC0603FR-07249KL
1	R3	16.2	Film Res, 1%	603	Yageo	RC0603FR-0716R2L
2	R4,R7	20.5k	Film Res, 1%	603	Yageo	RC0603FR-0720K5L
4	R5, R19, R24, R25	10k	Film Res, 1%	603	Yageo	RC0603FR-0710KL
1	R6	200K	Film Res, 5%	603	Yageo	RC0603JR-07200KL
1	R8	33k	Film Res, 5%	805	Yageo	RC0805JR-0733KL
1	R9	261	Film Res, 1%	603	Yageo	RC0603FR-07261RL
	R11, R21, R22		No Stuff		Yageo	
1	R13	604	Film Res, 1%	603	Yageo	RC0603FR-07604RL
1	R15	10	Film Res, 5%	805	Yageo	RC0805JR-0710RL

EV6003-N-00A BILL OF MATERIALS (continued)

Qty	Ref	Value	Description	Package	Manufacturer	Part Number
1	R16	0	Film Res, 5%	603	Yageo	RC0603JR-070RL
2	R17, R18	30.1k	Film Res, 1%	603	Yageo	RC0603FR-0730K1L
1	R20	100k	Film Res, 1%	603	Yageo	RC0603FR-07100KL
1	T1		Transformer	SMD	Würth Electronics	WE-750313291
1	U1		DC-DC Converter	SO-8	MPS	MP6003DN
1	U2		Photocoupler, 1-Ch	4-SMD	Sharp	PC357NT

TYPICAL PERFORMANCE CHARACTERISTICS

$V_{IN}=36V$, $V_{OUT}=5V$, $I_{OUT}=1A$, $T_A=25^{\circ}C$, unless otherwise noted.

Load Efficiency

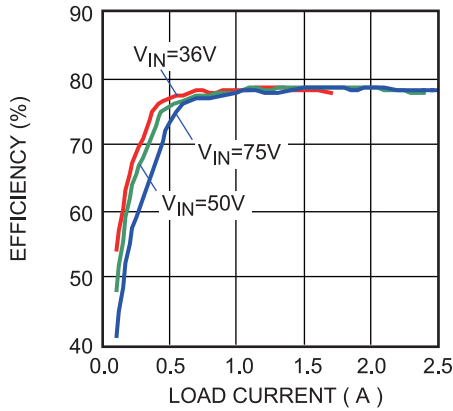

Load Regulation

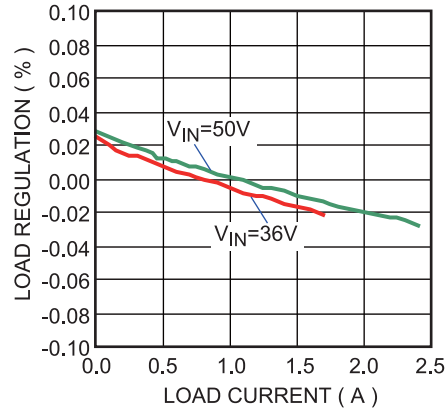

Line Regulation

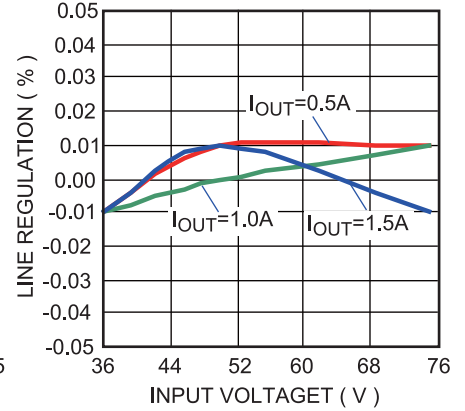

Line Efficiency

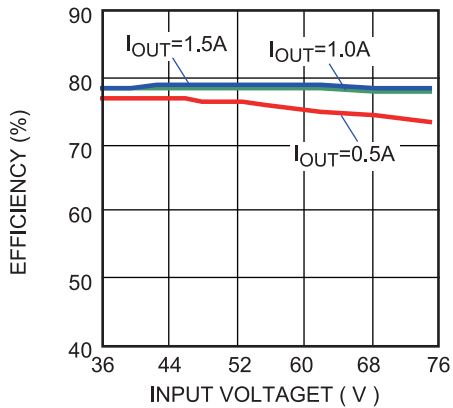

V_{FB} vs. Temperature

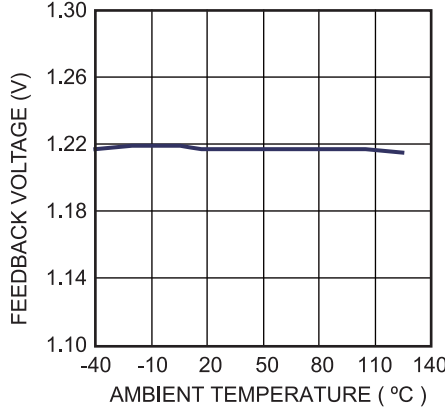

Switch Frequency vs. Temperature

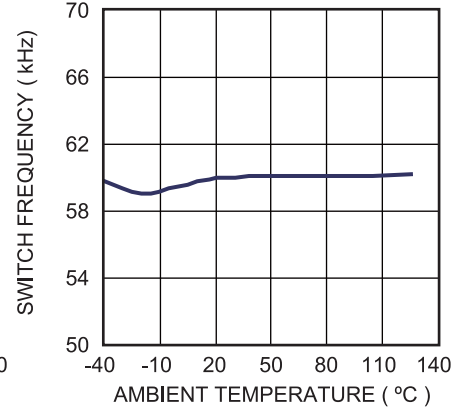

Power Ramp Up

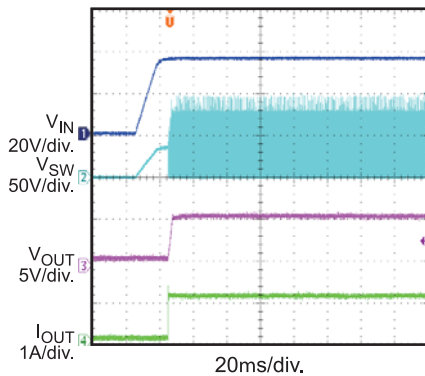

Power Ramp Down

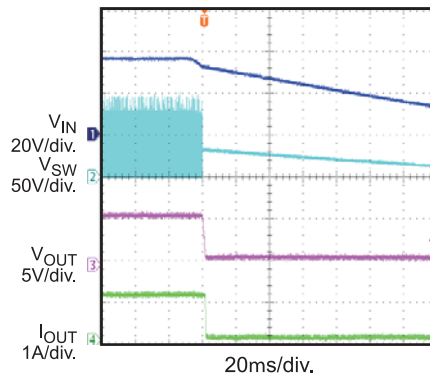

Short Output Protection

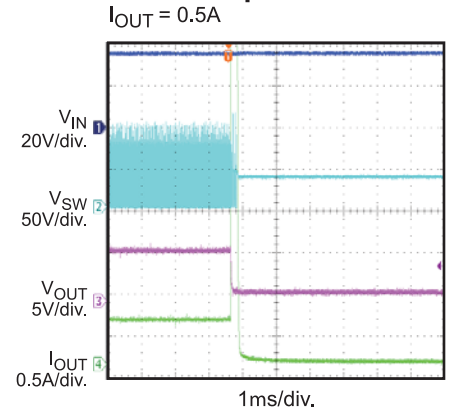

TYPICAL PERFORMANCE CHARACTERISTICS (CONTINUED)

$V_{IN}=36V$, $V_{OUT}=5V$, $I_{OUT}=1A$, $T_A=25^{\circ}C$, unless otherwise noted.

Enable Start Up

$V_{IN}=75V$

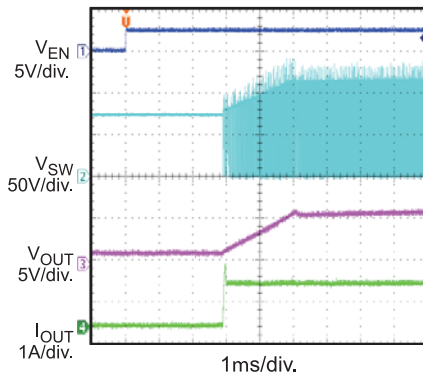

Enable Start Down

$V_{IN}=75V$

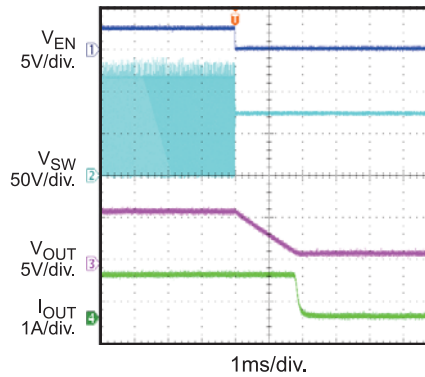

Short Output Recovery

$I_{OUT} = 0.5A$

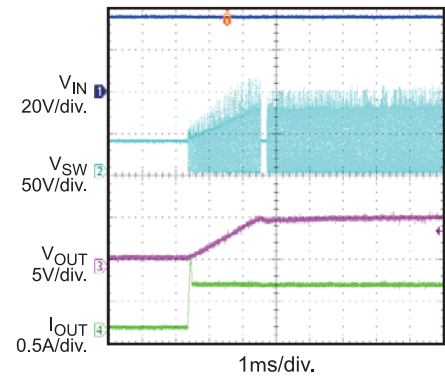

Steady State

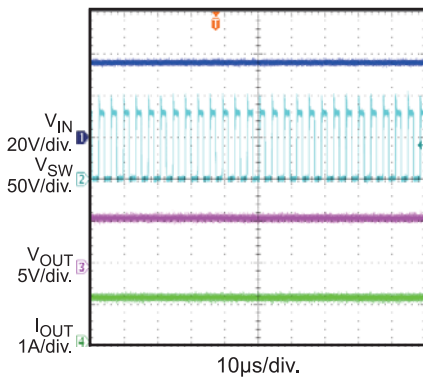

Steady State

$I_{OUT}=0.8A$

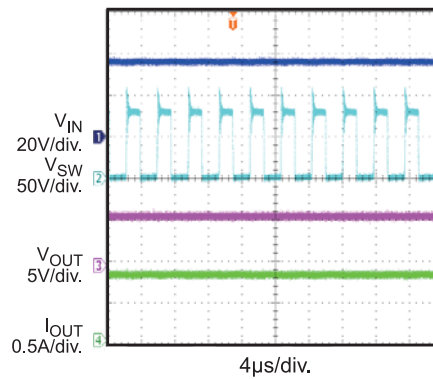

Steady State

$V_{IN} = 75V$

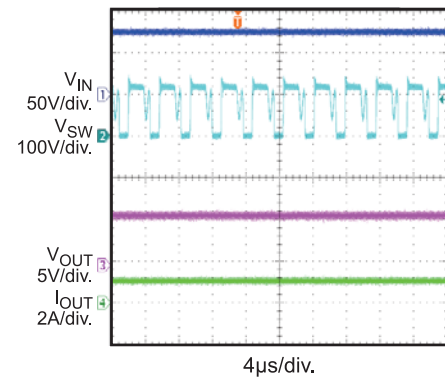

PRINTED CIRCUIT BOARD LAYOUT

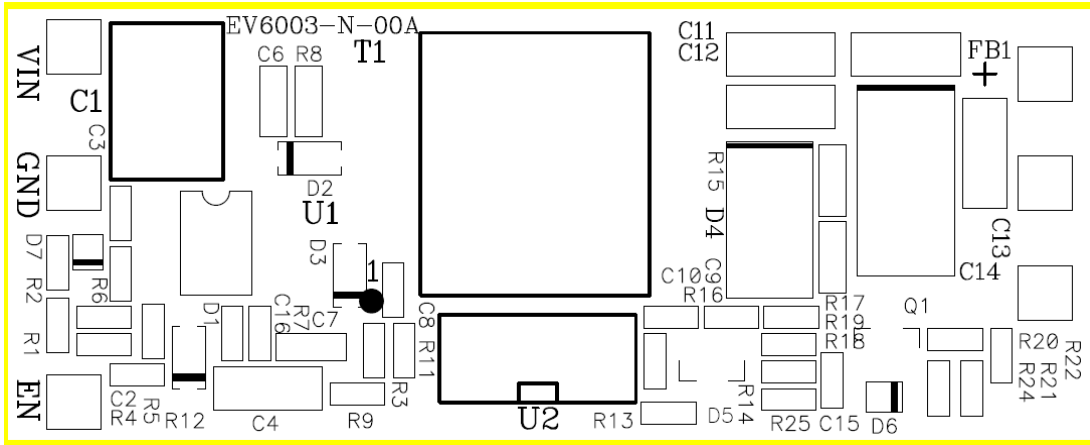

Figure 1: Top Silk Layer



Figure 2: Bottom Silk Layer

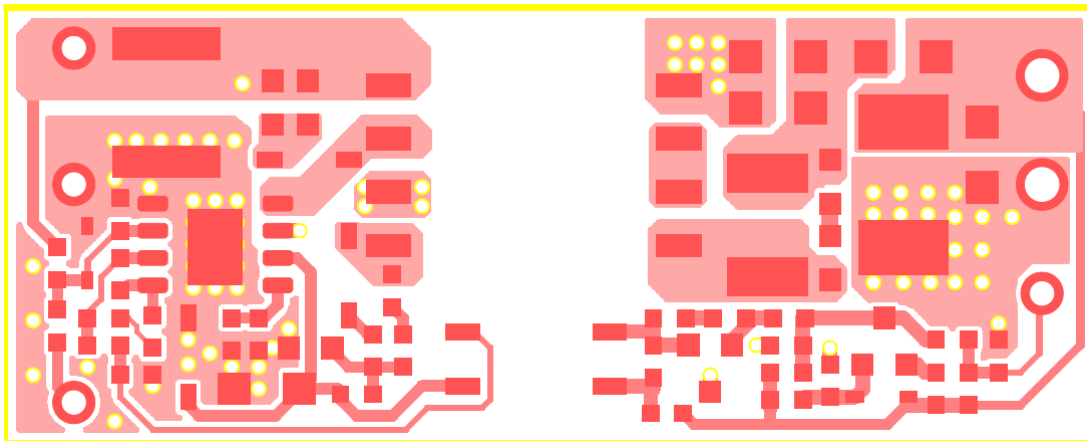

Figure 3: Top Layer

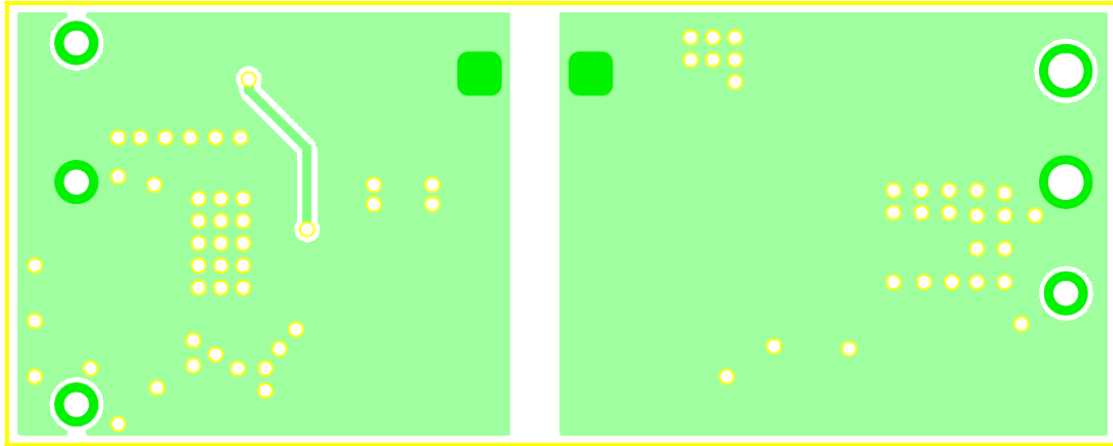

Figure 4: Bottom Layer

QUICK START GUIDE

1. Connect the positive terminal of the load to VOUT pin, and the negative terminal of the load to GND pin.
2. Preset power supply output to 24V to 120V and turn off the power supply.
3. Connect the positive terminal of the power supply output to VIN pin, and the negative terminal of the power supply output to GND pin.
4. Turn power supply on and the board will automatically startup.
5. To use Enable function, apply a digital input to EN pin. Drive EN with 2.5V-0V to turn on/off the regulator, and drive EN less than 0.7V to turn it off.

NOTICE: The information in this document is subject to change without notice. Please contact MPS for current specifications. Users should warrant and guarantee that third party Intellectual Property rights are not infringed upon when integrating MPS products into any application. MPS will not assume any legal responsibility for any said applications.