



EV6528-R-00A

5V to 60V, H-Bridge Gate Driver Evaluation Board

DESCRIPTION

The EV6528-R-00A is an evaluation board for the MP6528GR, an H-bridge gate driver.

The EV6528-R-00A operates from a supply voltage of up to 60V. It is configured to drive two half-bridges consisting of four N-channel power MOSFETs. The driving control signals are generated by the external controller, such as MCU, FPGA, etc.

ELECTRICAL SPECIFICATION

Parameter	Symbol	Value	Units
Input Voltage	V_{IN}	5 – 60	V
OC_REF Voltage	V_{OC_REF}	0.125 – 2.4	V
VCC Voltage	V_{CC}	3.3 or 5	V

FEATURES

- Wide 5V to 60V Input Voltage Range
- Programmable OCP Threshold
- Support 100% Duty Cycle Operation
- OCP, OTP
- Fault Indication Output

APPLICATIONS

- DC Brush Motors
- Automotive Actuators
- Power Converters
- Gate Openers

All MPS parts are lead-free, halogen-free, and adhere to the RoHS directive. For MPS green status, please visit the MPS website under Quality Assurance. "MPS" and "The Future of Analog IC Technology" are registered trademarks of Monolithic Power Systems, Inc.

EV6528-R-00A EVALUATION BOARD

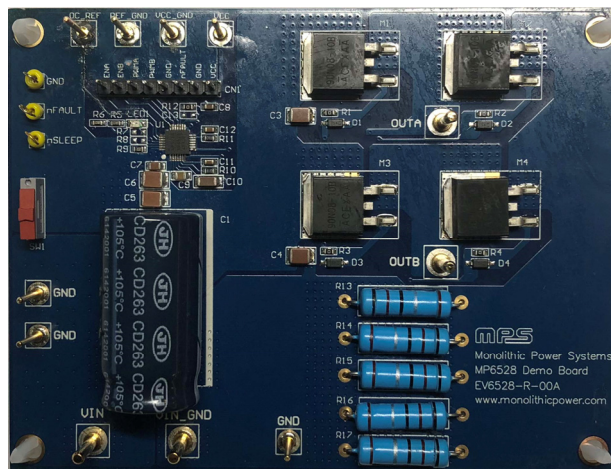

(L x W) 4.1" x 3.1" (10.3cm x 7.8cm)

Board Number	MPS IC Number
EV6528-R-00A	MP6528GR

QUICK START GUIDE

1. Attach the input voltage ($5V \leq V_{IN} \leq 60V$) and input ground to the VIN and GND connectors respectively.
2. Attach the VCC voltage (3.3V or 5V) to the VCC connector and switch the SW1 to the position 1 (Bottom side) to enable the chip.
3. Attach the OC_REF voltage ($0.125V \leq V_{OC_REF} \leq 2.4V$) to the OC_REF connector to set the OCP threshold.
4. Attach the driving control signals generated by the external controller to the CN1 connector.

EVALUATION BOARD SCHEMATIC

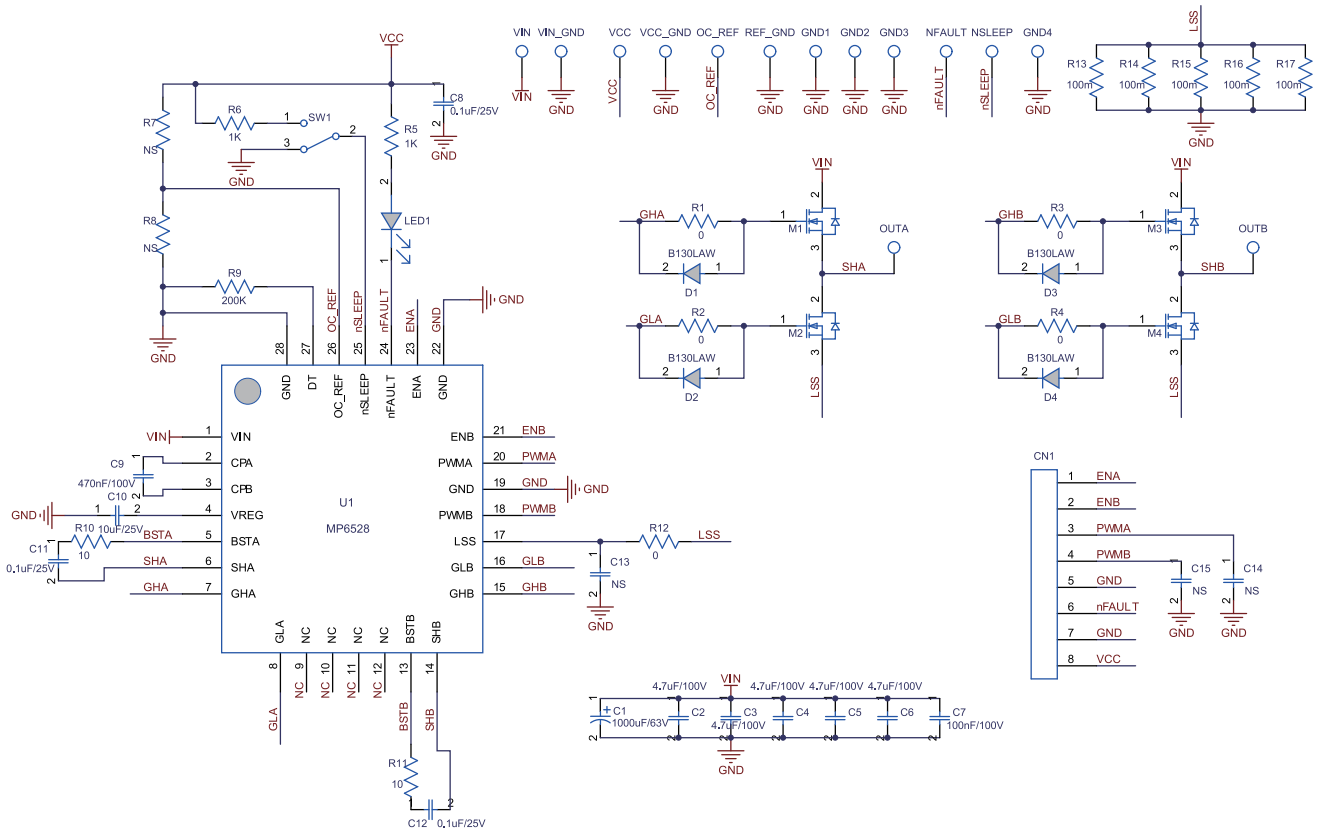

EV6528-R-00A BILL OF MATERIALS

Qty	Ref	Value	Description	Package	Manufacturer	Part Number
1	C1	1000uF	Electrolytic Cap. 63V	DIP	Jianghai	CD263-63V1000
5	C2, C3, C4, C5, C6	4.7μF	Ceramic Cap. 100V, X7S	1210	TDK	C3225X7S2A475K
1	C7	100nF	Ceramic Cap. 100V, X7R	0805	TDK	CGA4J2X7R2A104K
3	C8, C11, C12	100nF	Ceramic Cap. 25V, X8R	0603	Murata	GCM188R91E104KA37D
1	C9	470nF	Ceramic Cap. 100V, X7R	0805	Murata	GRM21BR72A474KA73L
1	C10	10μF	Ceramic Cap. 25V, X5R	1206	TDK	C3216X5R1E106K
3	C13, C14, C15	NS				
5	R1, R2, R3, R4, R12	0Ω	Film Resistor, 1%	0603	Yageo	RC0603FR-070RL
2	R5, R6	1kΩ	Film Resistor, 1%	0603	Yageo	RC0603FR-071KL
2	R7, R8	NS				
1	R9	200kΩ	Film Resistor, 1%	0603	Yageo	RC0603FR-07200KL
2	R10, R11	10Ω	Film Resistor, 1%	0603	Yageo	RC0603FR-0710RL
5	R13, R14, R15, R16, R17	100mΩ	Resistor, 1%, 2W	DIP	钰凌	
4	D1, D2, D3, D4		Schottky Diode, 30V, 1A	SOD-123	Diodes	B130LAW-7-F
4	M1, M2, M3, M4		N-channel MOSFET, 80V,90A, Qg=60nC, 11mOhm@Vgs=10V	TO-263	Analog Power	AM90N08-10B-T1-PE
1	LED1		LED. 红光	0805	佰鸿	2012SURC-11
1	SW1		Button	DIP	Würth	450301014042
1	CN1		8PIN. 2.54MM			61304011121
4	VIN, VIN_GND, OUTA, OUTB		2.0 公针			
7	VCC, VCC_GND, OC_REF, REF_GND, GND, GND, GND		1.0 公针			
3	NFAULT, NSLEEP, GND		Test Point			
1	U1		H-Bridge Gate Driver	QFN28 (4x4mm)	MPS	MP6528GR

PRINTED CIRCUIT BOARD LAYOUT

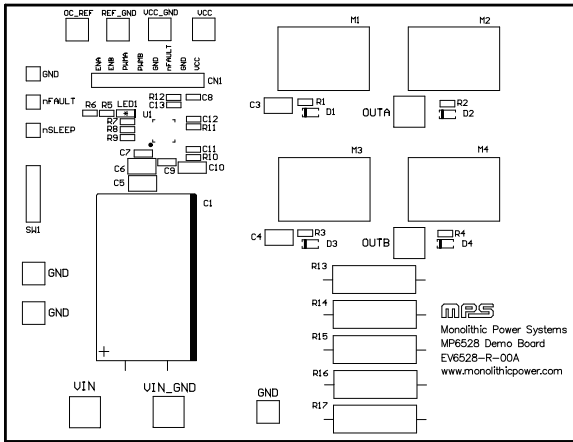

Figure 1: Top Silkscreen Layer

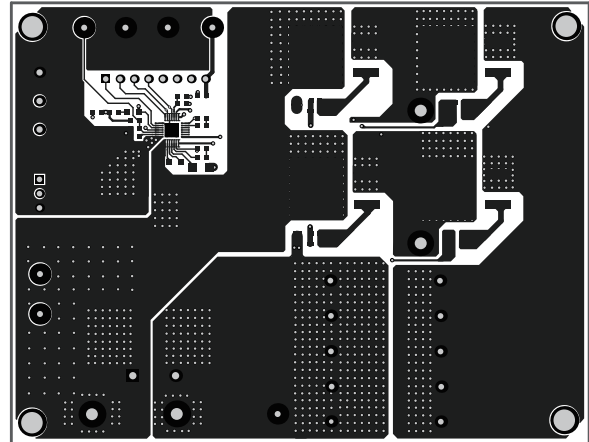

Figure 2: Top Layer

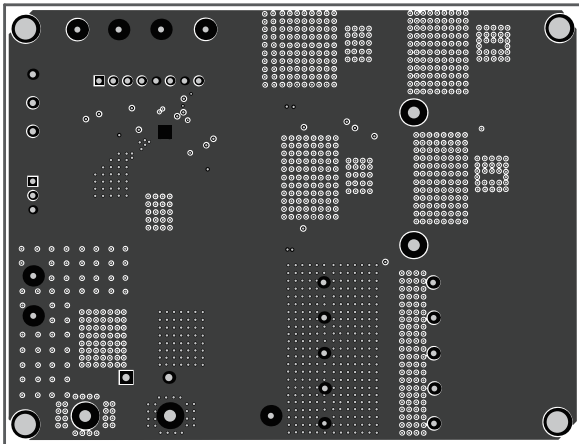

Figure 3: Inner 1

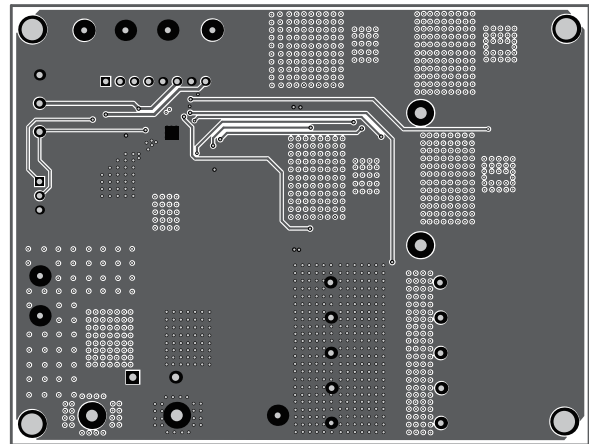

Figure 4: Inner 2

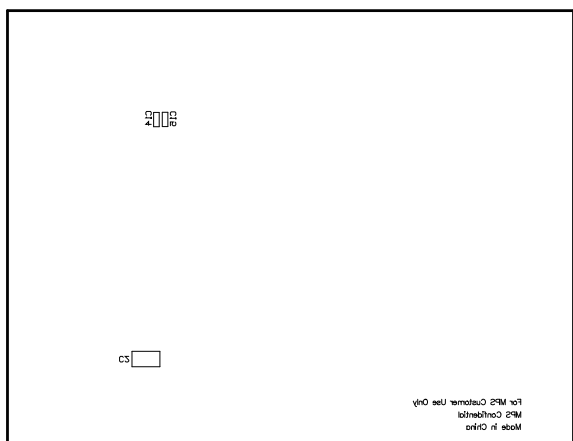

Figure 5: Bottom Silkscreen Layer

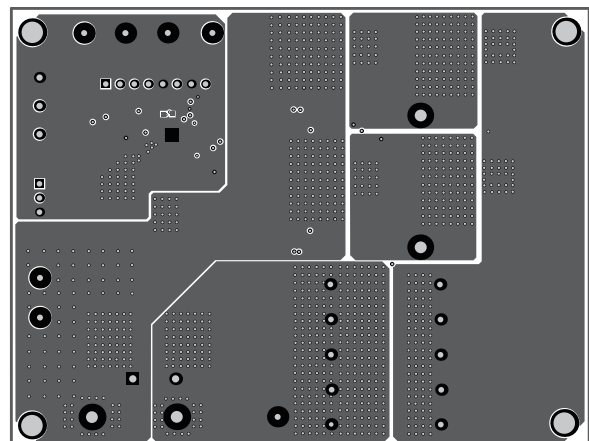

Figure 6: Bottom Layer

NOTICE: The information in this document is subject to change without notice. Users should warrant and guarantee that third party Intellectual Property rights are not infringed upon when integrating MPS products into any application. MPS will not assume any legal responsibility for any said applications.