

DESCRIPTION

The EV6534-U-00A is an evaluation board for the MP6534, a three-phase BLDC motor pre-driver.

It operates from a supply voltage of up to 55V. It is configured to drive 3 half bridges consisting of 6 N-channel Power MOSFETs. The rotor position information is provided by the Hall sensors assembled in the motor and the driving control signals are generated by the external controller, such as MCU, FPGA, etc.

ELECTRICAL SPECIFICATIONS

Parameter	Symbol	Value	Units
Input Voltage	VIN	5 - 55	V
OC_REF	OC_REF	0.1 - 2	V
Buck Output Voltage	Vb	5	V

FEATURES

- Wide 5V to 55V Input Voltage Range
- Programmable OCP Threshold
- Support 100% Duty Cycle Operation
- OCP, OTP
- Fault Indication Output

APPLICATIONS

- 3-Phase Brushless DC Motors and Permanent Magnet Synchronous Motors
- Power Drills
- Impact Drivers
- E-Bike

For MPS green status, please visit MPS website under Quality Assurance.

For MPS green status, please visit MPS website under Quality Assurance. MPS[®] and "The Future of Analog IC Technology" are Registered Trademarks of Monolithic Power Systems, Inc.

EV6534-U-00A EVALUATION BOARD

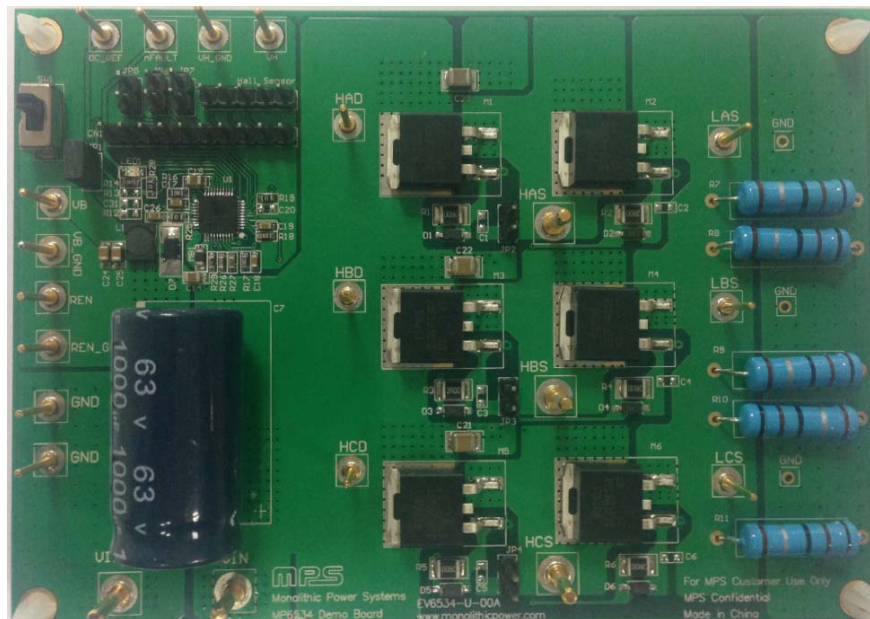

(L x W x H) 4.68" x 3.12" x 0.4"
(11.7cm x 7.8cm x 1cm)

Board Number	MPS IC Number
EV6534-U-00A	MP6534

EVALUATION BOARD SCHEMATIC

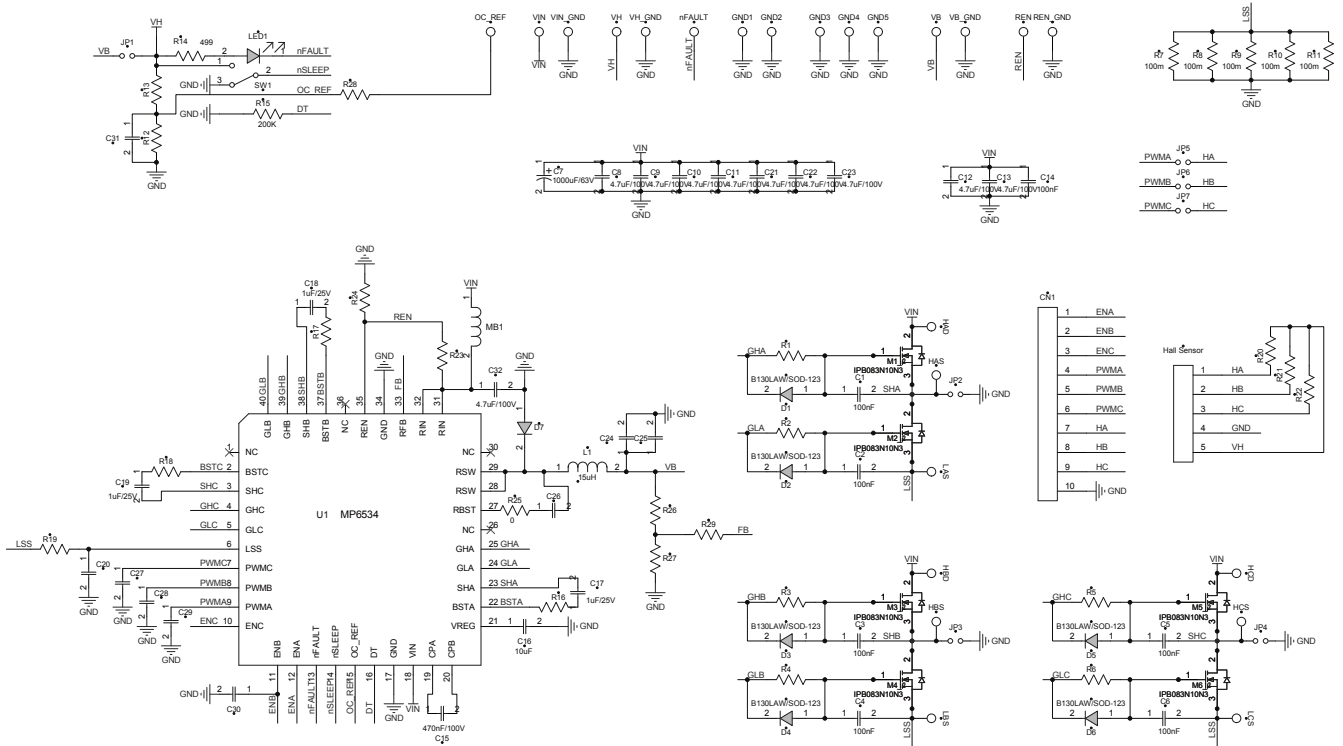

EV6534-U-00A BILL OF MATERIALS

Qty	RefDes	Value	Description	Package	Manufacturer	Manufacturer P/N
15	C1,C2,C3, C4,C5,C6, C20,C31, R12,R13, R20,R21, R22, R23, R24	NS				
1	C7	1000 μ F	Electrolytic Cap. 63V	DIP	Jianghai	CD263-63V1000
9	C8,C9,C10, C11,C12, C13,C21, C22,C23, C32	4.7 μ F	Ceramic Cap. 100V, X7S	SM1210	TDK	C3225X7S2A475K
1	C14	100nF	Ceramic Cap. 100V, X7R	SM0805	TDK	CGA4J2X7R2A104K
1	C15	470nF	Ceramic Cap. 100V, X7R	SM0805	Murata	GRM21BR72A474KA73L
1	C16	10 μ F	Ceramic Cap. 25V, X5R	SM1206	Murata	GRM31CR61E106KA12L
3	C17,C18, C19	1 μ F	Ceramic Cap. 25V, X7R	SM0603	Murata	GRM188R71E105KA12D
2	C24,C25	4.7 μ F	Ceramic Cap. 6.3V, X5R	SM0805	Murata	GRM219R60J475KE19D
1	C26	0.1 μ F	Ceramic Cap. 50V, X7R	SM0603	Murata	GCJ188R71H104KA12D
4	C27,C28, C29,C30	10nF	Ceramic Cap. 50V, X7R	SM0603	Murata	GRM188R71H103KA01D
6	R1,R2,R3, R4,R5,R6	2Ohm	Film Resistor. 1%	SM1210	Yageo	RC1210FR-072RL
5	R7,R8,R9, R10,R11	100mOhm	Resistor. 2W	DIP	Minda	
1	R14	499Ohm	Film Resistor. 1%	SM0603	Yageo	RC0603FR-07499RL
1	R15	200k	Film Resistor ,1%	SM0603	Yageo	RC0603FR-07200KL
3	R16,R17, R18	10Ohm	Film Resistor ,1%	SM0603	Yageo	RC0603FR-0710RL
3	R19,R25, R28	0Ohm	Film Resistor ,1%	SM0603	Yageo	RC0603FR-070RL
1	R29	510k	Film Resistor ,1%	SM0603	Yageo	RC0603FR-07510KL
1	R26	124k	Film Resistor ,1%	SM0603	Yageo	RC0603FR-07124KL
1	R27	23.7k	Film Resistor ,1%	SM0603	Yageo	RC0603FR-0723K7KL
6	M1,M2,M3, M4,M5,M6		N-channel MOSFET, 100V,57A, Qg=130nC,23m Ohm@Vgs=10V, Id=28A	D ² Pak	IR	IRF3710S

EV6534-U-00A BILL OF MATERIALS *(continued)*

Qty	RefDes	Value	Description	Package	Manufacturer	Manufacturer P/N
6	D1,D2,D3, D4,D5,D6		Schottky Diode. 30V, 1A	SOD-123	Diodes	B130LAW-7-F
1	D7		Schottky Rect. 60V, 1A	PowerDIT M123	Diodes	DFLS160
1	L1	15 μ H	Inductor, Idc=0.7A	SMD	TDK	VLCF4020T-150MR68
						VLF504015MT-150M
1	MB1		Idc=1A	SM0805	Würth	742792097
1	LED1		LED. 红光	SM0805	Bright LED	BL-HUF35A-TRB
1	SW1		Button			SK-12D01EG4
1	CN1		10Pin, 2.54mm			
1	Hall Sensor		5Pin, 2.54mm			
7	JP1,JP2,JP3, JP4,JP5,JP6, JP7		2Pin, 2.54mm (with Short Jumper)			
1	U1		3-Phase BLDC Motor Pre-Driver	QFN-40 (5x5mm)	MPS	MP6534GU

PRINTED CIRCUIT BOARD LAYOUT

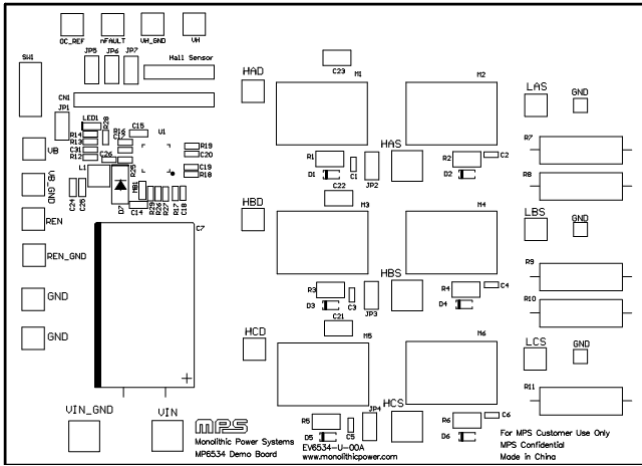

Figure 1—Top Silk Layer

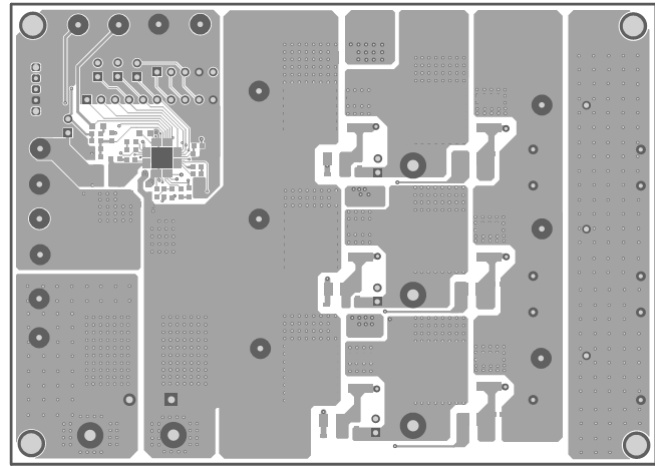

Figure 2—Top Layer

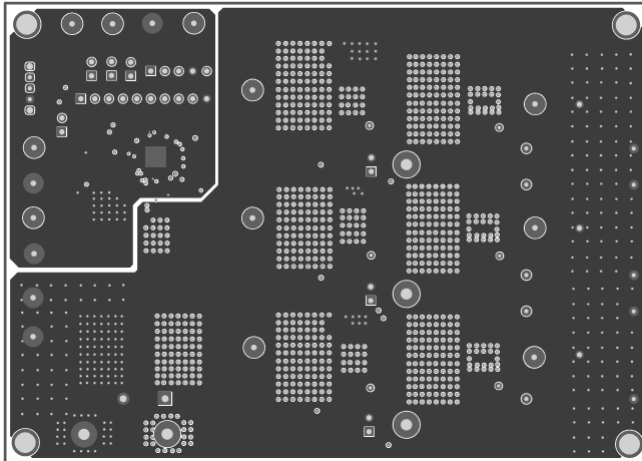

Figure 3—Inner 1 Layer

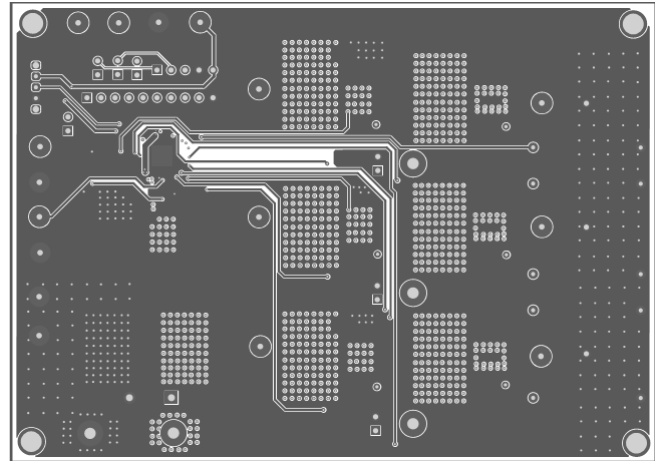

Figure 4—Inner 2 Layer

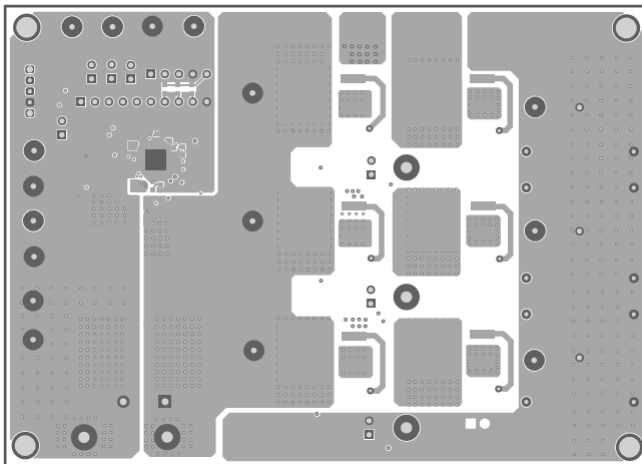

Figure 5—Bottom Layer

QUICK START GUIDE

1. Attach the input voltage ($5V \leq V_{IN} \leq 55V$) and input ground to the VIN and GND connectors respectively.
2. Attach the logic power (3.3V or 5V) and logic power ground to the REN and REN_GND connector.
3. Switch the SW1 to the position 1(Top side) to enable the chip.
4. Attach the OCP reference voltage ($0.1V \leq V_{REF} \leq 2V$) to the OC_REF connector to set OCP threshold.
5. Attach the hall signals coming from the motor to the Hall Sensor connector.
6. Attach the driving control signals generated by the external controller to the CN1 connector.

NOTICE: The information in this document is subject to change without notice. Users should warrant and guarantee that third party Intellectual Property rights are not infringed upon when integrating MPS products into any application. MPS will not assume any legal responsibility for any said applications.