

DESCRIPTION

The MP8004 is an integrated IEEE 802.3af PoE compliant Powered Device (PD) power supply solution. It includes a PD interface and an isolated/non-isolated flyback converter.

The PD interface includes detection and classification modes as well as a 100V output pass device. Inrush current limit is included to slowly charge the input capacitor.

The DC-DC converter includes a 150V power switch and is capable of delivering 13W output power with high efficiency. It has an internal soft-start, auto-retry, over current, short circuit, and over voltage protection. It can also skip cycles during light load condition.

The MP8004 is available in thermally enhanced 4x6mm QFN20 package.

ELECTRICAL SPECIFICATIONS

Parameter	Symbol	Value	Units
Input voltage	V _{in}	36-57 ⁽¹⁾	V
Output voltage	V _{out}	12	V
Output current	I _{out}	1	A
Frequency	F _{sw}	275	kHz

Note:

- It requires higher than 42V input for startup, after startup, it can work down to 36V. Meets IEEE 802.3af Specifications

FEATURES

- Meets IEEE 802.3af Specifications
- 100V, 1Ω Integrated Pass Switch
- 420mA DC Input Current Limit
- 150V, 0.45Ω Integrated Switch for Power Converter
- Cycle-by-Cycle Switching Current Limit
- Integrated 100V Startup Circuit
- Programmable Switching Frequency
- Duty Cycle Limiting with Line Feed Forward
- Internal Slope Compensation
- OCP, SCP and OTP Protection
- 4x6mm QFN20 Package

APPLICATIONS

- VoIP Telephones
- Security Camera Systems
- Wireless Access Points/Wireless LAN
- Small-cell Base Stations
- Safety Backup Power
- Remote Internet Power

All MPS parts are lead-free and adhere to the RoHS directive. For MPS green status, please visit MPS website under Products, Quality Assurance page.

"MPS" and "The Future of Analog IC Technology" are Registered Trademarks of Monolithic Power Systems, Inc.

EV8004-QW-00A EVALUATION BOARD



(L x W x H) (12.5cm x 4cm x 1.5cm)

Board Number	MPS IC Number
EV8004-QW-00A	MP8004GQW

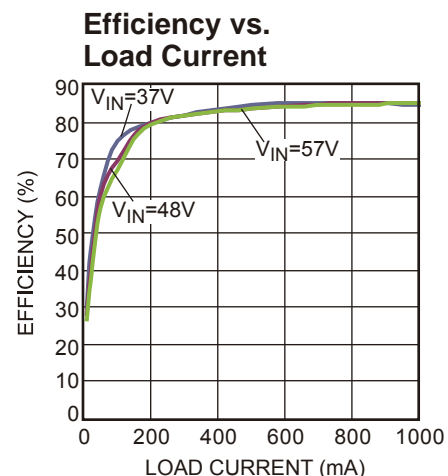

EVALUATION BOARD SCHEMATIC

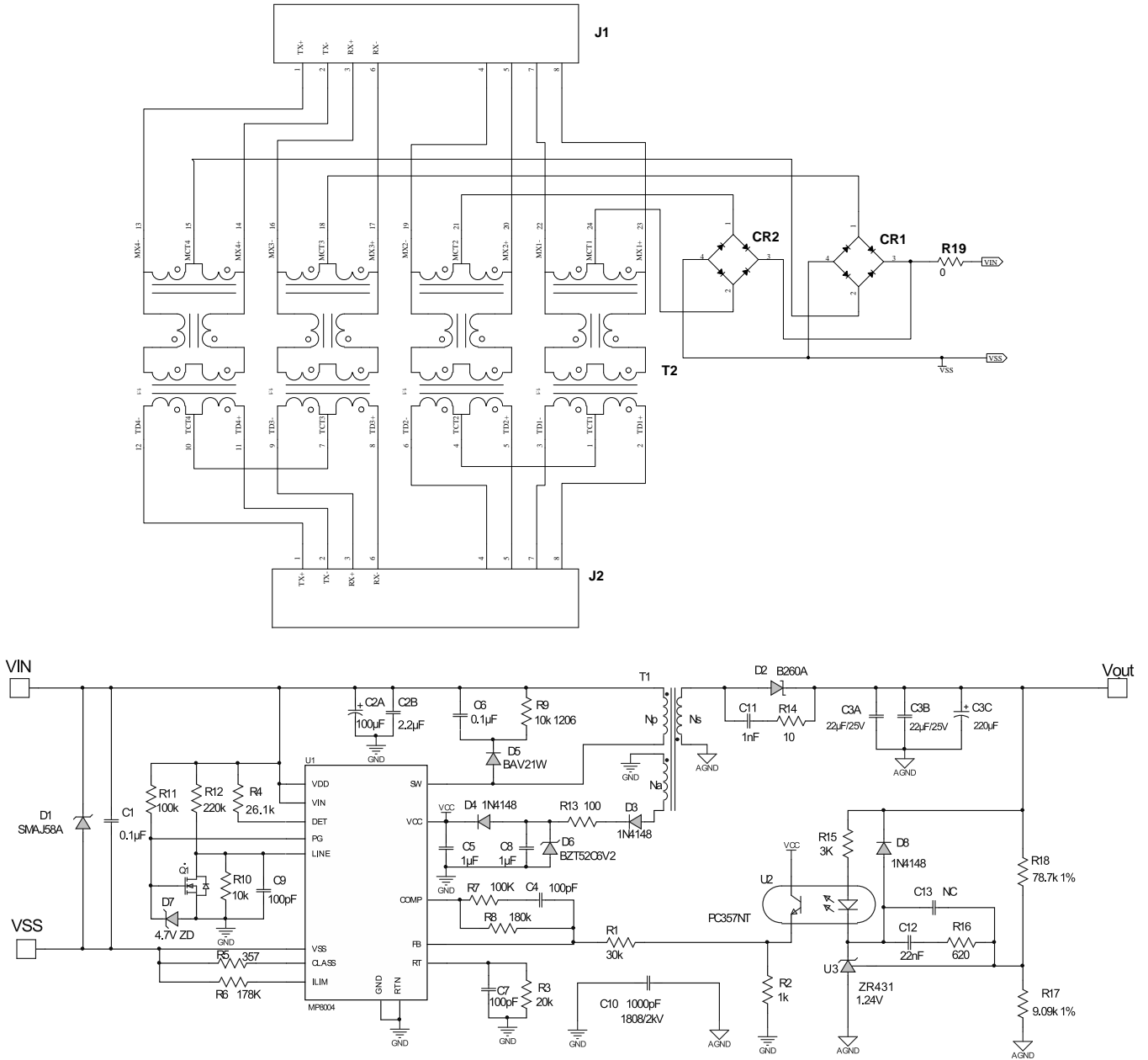

EV8004-QW-00A BILL OF MATERIALS

Qty	Ref	Value	Description	Package	Manufacturer	Part Number
2	C1,C6	0.1µF	Ceramic Cap. 100V, X7R	1206	Murata	GRM319R72A104KA01D
1	C2A	100µF	100V Electrolytic	DIP	Rubycon	100YXG100MEFC10X23
2	C2B	2.2µF	Ceramic Cap. 100V, X7R	1210	Murata	GRM32ER72A225KA35L
2	C3A,C3B	22µF	Ceramic Cap, 25V, X5R	1210	Murata	GRM32ER61E226KE15L
1	C3C	220µF	35V Electrolytic	DIP	Chemi-con	EKY-350EC3221MH15D-ND
3	C4,C7,C9	100pF	Ceramic Cap,50V,C0G	0603	muRata	GRM1885C1H101JA01D
2	C5, C8	1µF	Ceramic Cap,16V,X7R	0603	muRata	GRM188R71C105KA12D
1	C10	1000pF	Ceramic Cap, 2000V X7R	1808	muRata	GR442QR73D102KW01L
1	C11	1nF	Ceramic Cap, 50V, C0G	0603	muRata	GRM1885C1H102JA01D
1	C12	22nF	Ceramic Cap, 25V, X7R	0603	muRata	GRM188R71E223KA01D
0	C13	NC				
1	R1	30kΩ	Film Res, 1%	0603	YAGEO	RC0603FR-0730KL
1	R2	1kΩ	Film Res, 1%	0603	YAGEO	RC0603FR-071KL
1	R3	20kΩ	Film Res, 1%	0603	YAGEO	RC0603FR-0720KL
1	R4	26.1kΩ	Film Res, 1%	0603	YAGEO	RC0603FR-0726K1L
1	R5	357Ω	Film Res, 1%	0603	YAGEO	RC0603FR-07357RL
1	R6	178kΩ	Film Res, 1%	0603	YAGEO	RC0603FR-07178KL
2	R7, R11	100kΩ	Film Res, 1%	0603	YAGEO	RC0603FR-07100KL
1	R8	180kΩ	Film Res, 1%	0603	YAGEO	RC0603FR-07180KL
1	R9	10kΩ	Film Res, 1%	1206	YAGEO	RC1206FR-0710KL
1	R10	10kΩ	Film Res, 1%	0603	YAGEO	RC0603FR-0710KL
1	R12	220kΩ	Film Res, 1%	0603	YAGEO	RC0603FR-07220KL
1	R13	100Ω	Film Res, 1%	0603	YAGEO	RC0603FR-07100RL
1	R14	10Ω	Film Res, 1%	0603	YAGEO	RC0603FR-0710RL
1	R15	3kΩ	Film Res, 1%	0603	YAGEO	RC0603FR-03KL
1	R16	620Ω	Film Res, 1%	0603	YAGEO	RC0603FR-07620RL
1	R17	9.09kΩ	Film Res, 1%	0603	YAGEO	RC0603FR-079K09L
1	R18	78.7kΩ	Film Res, 1%	0603	YAGEO	RC0603FR-0778K7L
1	R19	0Ω	Film Res, 1%	1206	YAGEO	1821CR06T05NN0R
1	D1	SMAJ58A	TVS	SMA	Littelfuse	SMAJ58A
1	D2	B260A	Diode Schottky, 60V, 2A	SMA	Diodes Inc	B260A
3	D3, D4, D8	1N4148	Diode Switch, 75V, 200mW	SOD-323	Diodes Inc	1N4148WS-7-F
1	D5	BAV21W	Diode Switch, 200V, 250mW	SOD-123	Diodes Inc	BAV21W-7-F

EV8004-QW-00A BILL OF MATERIALS (continued)

Qty	Ref	Value	Description	Package	Manufacturer	Part Number
1	D6	6.2V	Diode Zener, 6.2V, 500mW	SOD-123	Diodes Inc	BZT52C6V2-7
1	D7	4.7V	Diode Zener, 4.7V 500mW	SOD-123	Diodes Inc	BZT52C4V7-13
1	Q1	2N7002	N-FET	SOT-23	Diodes Inc	2N7002-7-F
1	U1	MP8004	PD Controller	QFN20	MPS	MP8004GQW-Z
1	U2	PC357	Photocoupler, 1-Ch	4-SMD	Sharp	PC357NT
1	U3	ZR431	REG VLT ADJ 1.24V	SOT-23	ZETEX	ZR431LF01
1	T1 ⁽²⁾	Transformer	Core=EE13, Np:Ns:Na=22:9:6, Lp=90uH	DIP	Emei	
			Würth 12V/1A transformer Lp=100µH, Np: Ns: Na=4.5:1.5:1	SMD	Würth Elektronik	750311424
1	T2	749020011A	LAN-Transformer WE-LAN	SMD	Würth Elektronik	749020011A
2	J1,J2	RJ45-8N4-B	RJ Jack / Signal Line EMI/RFI Filters 6 TRMN BRD/CBLE GRND 8 PIN BLOCK INDUCTOR	RJ45-TAB DOWN	Tyco Electronics	RJ45-8N4-B
2	CR1, CR2	DF02S	1.0A SURFACE MOUNT GLASS PASSIVATED BRIDGE RECTIFIER	DF-S	Diodes Inc	DF02S

Note:

2) On standard EVB, the transformer is from Emei. There is one layout option for 750311424 transformer on EVB.

EVB TEST RESULTS

$V_{IN}=48V$, $V_{OUT}=12V$, $I_{OUT}=1A$, $T_A=25^{\circ}C$, unless otherwise noted.

Efficiency vs. Load Current

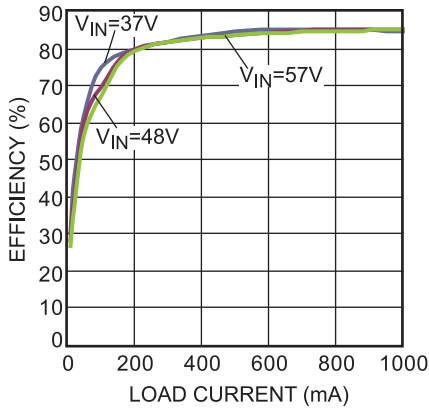

Load Regulation

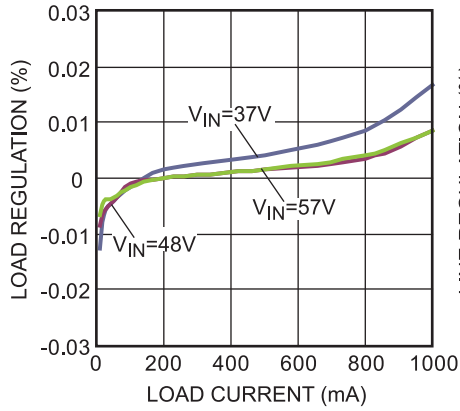

Line Regulation

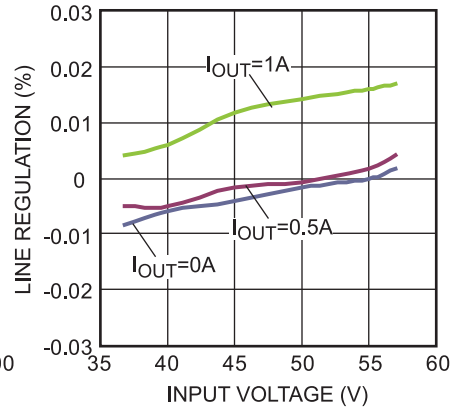

Case Temperature Rising vs. Load Current

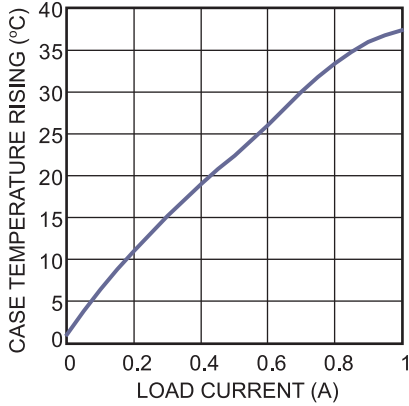

Magnitude and Phase vs. Frequency

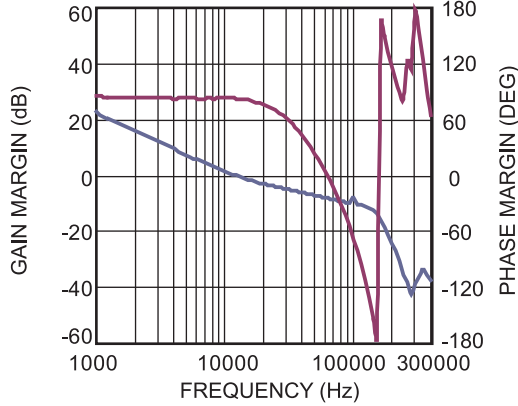

EVB TEST RESULTS (continued)

$V_{IN}=48V$, $V_{OUT}=12V$, $I_{OUT}=1A$, $T_A=25^{\circ}C$, unless otherwise noted.

Steady State

$I_{OUT} = 0A$

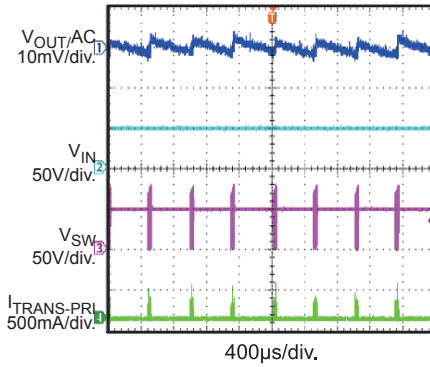

Steady State

$I_{OUT} = 1A$

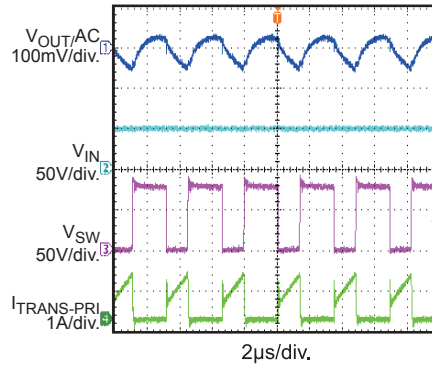

V_{IN} Startup

$I_{OUT} = 0A$

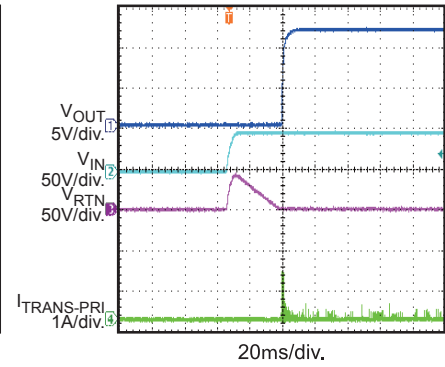

V_{IN} Startup

$I_{OUT} = 1A$

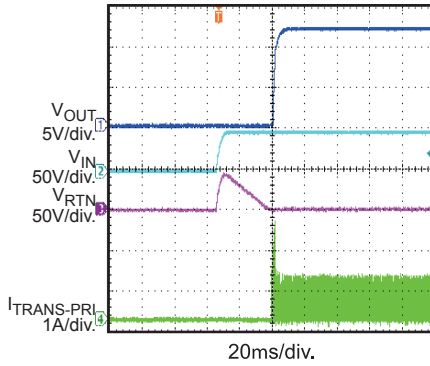

V_{IN} Shutdown

$I_{OUT} = 0A$

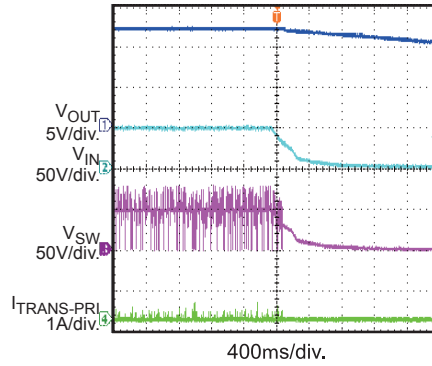

V_{IN} Shutdown

$I_{OUT} = 1A$

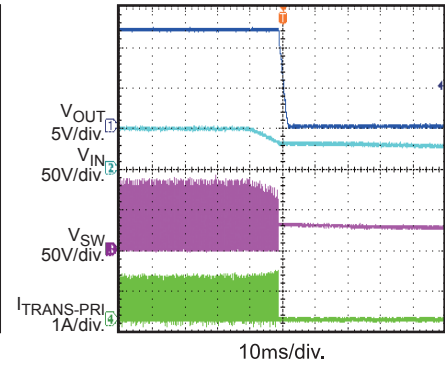

Load Transient

$I_{OUT} = 0A \rightarrow 0.5A$,
 $I_{RAMP} = 800mA/\mu s$

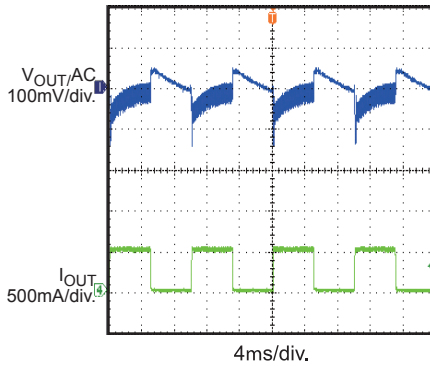

Load Transient

$I_{OUT} = 0.5A \rightarrow 1A$,
 $I_{RAMP} = 800mA/\mu s$

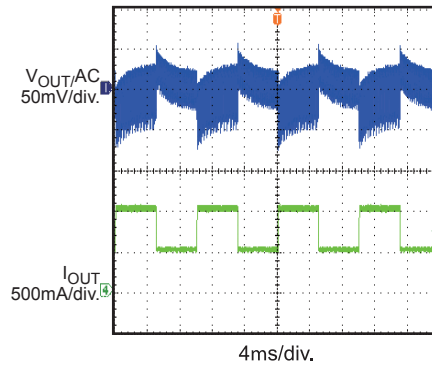

SCP Entry

$I_{OUT} = 0A$ to short

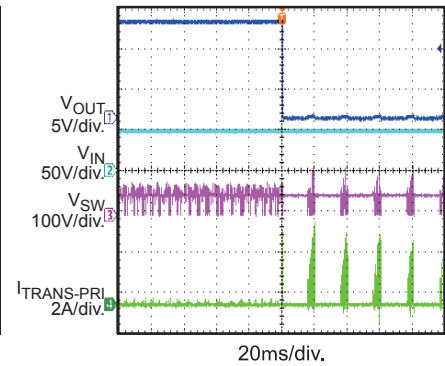

EVB TEST RESULTS *(continued)*

$V_{IN}=48V$, $V_{OUT}=12V$, $I_{OUT}=1A$, $T_A=25^{\circ}C$, unless otherwise noted.

SCP Recovery

I_{OUT} = short to 0A

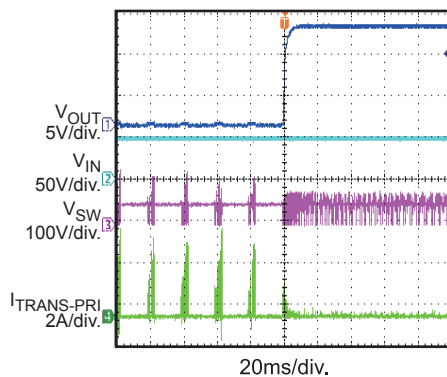

PRINTED CIRCUIT BOARD LAYOUT

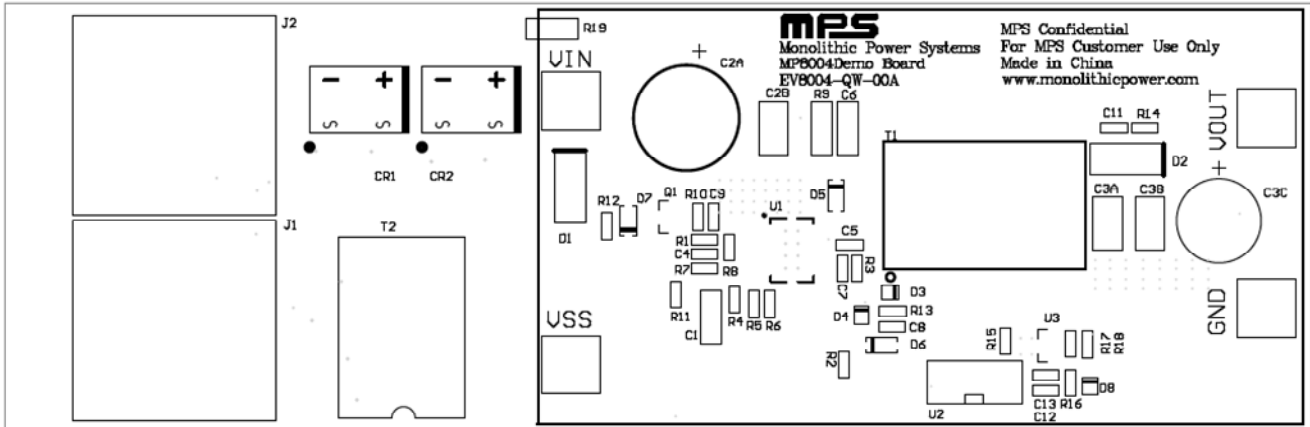

Figure 1: Top Silk Layer

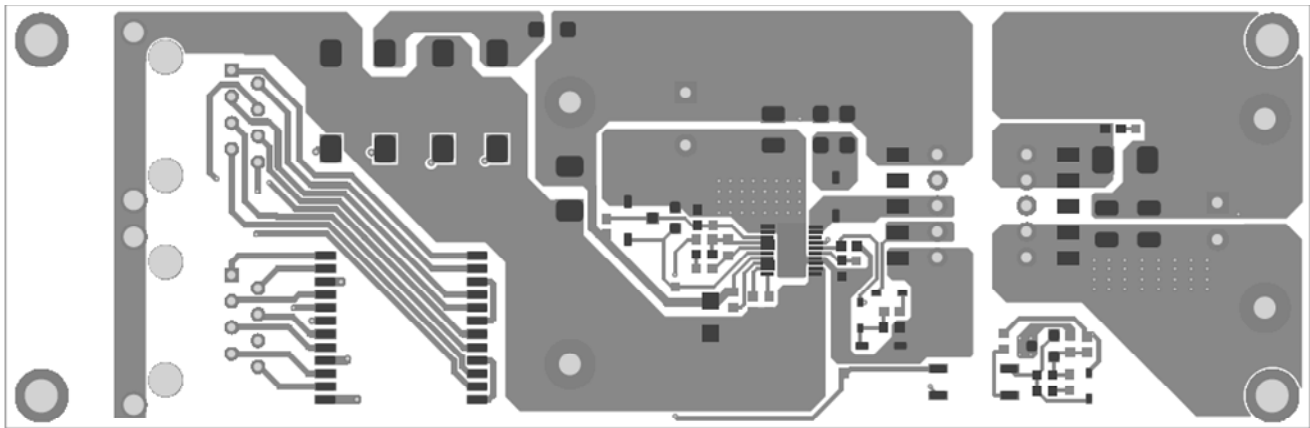

Figure 2: Top Layer

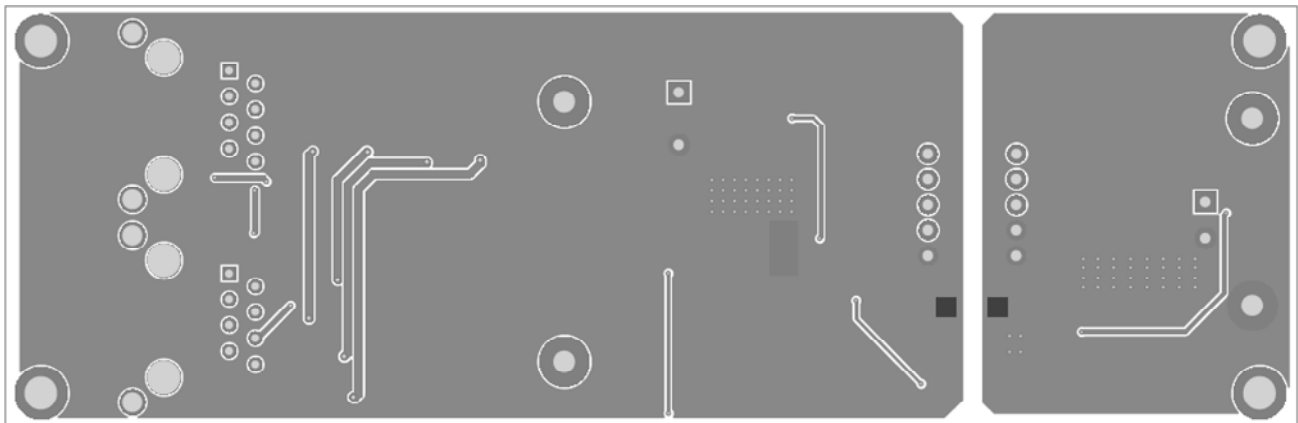

Figure 3: Bottom Layer

QUICK START GUIDE

1. Connect the load between VOUT (positive) and GND (negative) terminals.
2. Plug the cable coming from the PSE, carrying the input voltage for the PD, into the Ethernet Jack J1. The board will automatically startup.
3. External DC supply can also be used to evaluate EV8004-QW-00A. Preset the power supply output to 42V – 57V and turn off the power supply. Connect the positive terminal of the power supply output to the VIN pin and the negative terminal of the power supply output to the VSS pin. Turn the power supply on. The board will automatically startup.

NOTICE: The information in this document is subject to change without notice. Please contact MPS for current specifications. Users should warrant and guarantee that third party Intellectual Property rights are not infringed upon when integrating MPS products into any application. MPS will not assume any legal responsibility for any said applications.