

## DESCRIPTION

EV8007-V-00C Evaluation Board is designed to demonstrate the capability of MP8007's primary-side regulate fly-back function. This board supports IEEE 802.3af PoE compliant Powered Device with PD interface and flyback power converter. It is targeted for isolated 13W PoE application.

The PD interface has all the functions of IEEE 802.3af, including detection, classification, inrush current, operation current limit as well as 100V Hot-swap MOSFET. The DCDC converter uses fixed peak current and variable frequency discontinuous conduction mode (DCM) to regulate constant output voltage.

The MP8007 is available in QFN-28 (4mmX5mm ) package.

## ELECTRICAL SPECIFICATIONS

Parameter	Symbol	Value	Units
Input voltage	$V_{IN}$	37-57	V
Adapter Voltage	$V_{ADAPTOR}$	24	V
Output voltage	$V_{OUT}$	12	V
Output current	$I_{OUT}$	1 <sup>(1)</sup>	A

### Notes:

(1) When using 24V adapter input, the maximum output current will be lower than 1A, it is limited by transformer design.

## FEATURES

- Primary-side Regulate Flyback without Opto-coupler Feedback
- Integrated 180V Switching Power MOSFET
- Internal 80V Startup Circuit
- Up to 3A Programmable Current Limit
- Discontinuous Conduction Work Mode
- Include OLP, OVP, Open Circuit and Thermal Protection
- Minimal External Components Count
- Available in QFN-28 4mmx5mm Package

## APPLICATIONS

- Security Camera
- VoIP Phones
- WLAN Access Points
- General Flyback Converter

All MPS parts are lead-free, halogen free, and adhere to the RoHS directive. For MPS green status, please visit MPS website under Quality Assurance. "MPS" and "The Future of Analog IC Technology" are Registered Trademarks of Monolithic Power Systems, Inc.

## EV8007-V-00C EVALUATION BOARD

TBD	
(L x W x H) (11.5cm x 4.5cm x 1.5cm)	
<b>Board Number</b>	<b>MPS IC Number</b>
EV8007-V-00C	MP8007

**Efficiency vs. Load Current**

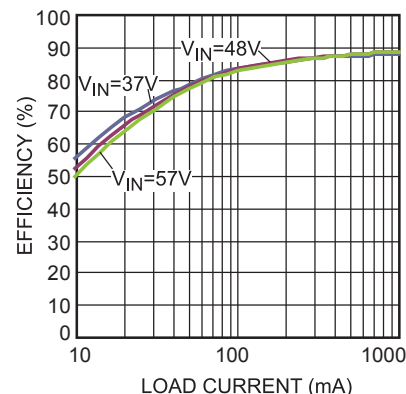

EVALUATION BOARD SCHEMATIC

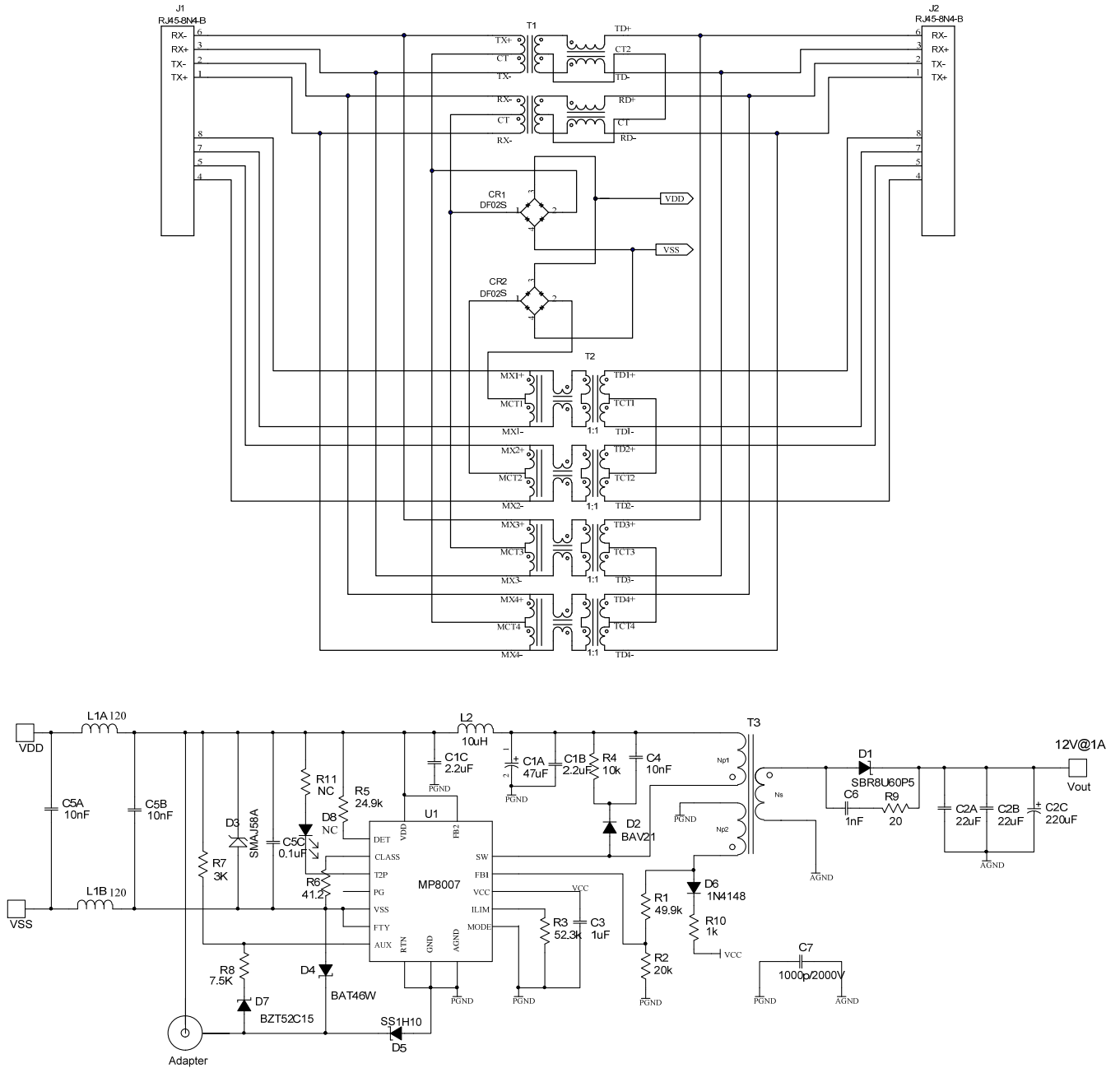

## EV8007-V-00C BILL OF MATERIALS

Qty	Ref	Value	Description	Package	Manufacturer	Part Number
1	C1A	47 $\mu$ F	47 $\mu$ F 100V CD284 E-Cap. 10X12.5mm	DIP	JiangHai	47 $\mu$ F/100V
2	C1B,C1C	2.2 $\mu$ F	Ceramic Cap, 100V, X7R	1210	MuRata	GRM32ER72A225KA35L
2	C2A,C2B	22 $\mu$ F	Ceramic Cap.,25V,X7R	1210	MuRata	GRM32ER71E226KE15L
1	C2C	220 $\mu$ F	220 $\mu$ F 25V CD284 E-Cap,8X12.5mm	DIP	JiangHai	220 $\mu$ F/25V
1	C3	1 $\mu$ F	Ceramic Cap,10V,X7R	0603	MuRata	GRM188R71A105KA61D
3	C4,C5A,C5B	10nF	Ceramic Cap,100V,X7R	0805	MuRata	GRM216R72A103KA01D
1	C5C	0.1 $\mu$ F	Ceramic Cap. 100V, X7R	1206	MuRata	GRM319R72A104KA01D
1	C6	1nF	Ceramic Cap,100V,X7R	0603	MuRata	GRM188R72A102KA01D
1	C7	1nF	Ceramic Cap. 2000V X7R	1808	MuRata	GR442QR73D102KW01L
1	R1	49.9k	Film Res,1%	0603	ROYAL	RC0603FR-0749K9L
1	R2	20k	Film Res,1%	0603	ROYAL	RC0603FR-0720KL
1	R3	52.3k	Film Res,1%	0603	ROYAL	RC0603FR-0752K3L
1	R4	10k	Film Res,1%	1206	ROYAL	RC1206FR-0710KL
1	R5	24.9k	Film Res,1%	0603	ROYAL	RC0603FR-0724K9L
1	R6	41.2	Film Res,1%	0603	ROYAL	RC0603FR-0741R2L
1	R7	3k	Film Res,1%	0603	ROYAL	RC0603FR-073KL
1	R8	7.5k	Film Res,5%	0603	ROYAL	RC0603JR-077K5L
1	R9	20	Film Res,1%	0805	ROYAL	RC0805FR-0720RL
1	R10	1k	Film Res,1%	0603	ROYAL	RC0603FR-071KL
0	R11	NC				
1	D1	SBR8U60P5	8A 60V SUPER BARRIER RECTIFIER	POWERDI 5	Diodes	SBR8U60P5
1	D2	BAV21	Switching Diode 200V 200mW	SOD-123	Diodes	BAV21W-7-F
1	D3	SMAJ58A	TVS	SMA	Little fuse	SMAJ58A
1	D4	BAT46W	100V, DIODE	SOD-123	Diodes	BAT46W-7-F
1	D5	SS1H10	100V, SCHOTTKY	DO-214AC	VISHAY	SS1H10-E3/61T
1	D6	1N4148	Switching Diode 75V 250mW	SOD-323	Diodes	1N4148WS-7
1	D7	BZT52C15	Zener Diode, 15V	SOD-123	Diodes	BZT52C15
0	D8	NC				
0	T1	NC				
1	T2	749020011A	LAN-Transformer WE-LAN	SMD	Würth	749020011A

**EV8007-V-00D BILL OF MATERIALS (continued)**

Qty	Ref	Value	Description	Package	Manufacturer	Part Number
1	T3	42.9uH	Np:Ns:Na=20:9:5, Lp=42.9uH, Core=EP13	EP13	Coilcraft	CX9629-AL
2	L1A,L1B	120	120mΩ@100MHz	1206	Würth	742792113
1	L2	10uH	Isat=4.9A, Irms=4.9A		Coilcraft	XAL5050-103MEC
2	J1,J2	RJ45-8N4-B	RJ Jack / Signal Line EMI/RFI Filters 6 TRMN BRD/CBLE GRND 8 PIN Block Inductor	RJ45-TAB	Tyco	RJ45-8N4-B
2	CR1, CR2	DF02S	1.0A Surface Mount Glass Passivated Bridge Rectifier	DF-S	Diodes Inc	DF02S
1	U1	MP8007	IEEE 802.3af Compatible PSR Flyback PD Device	QFN-28	MPS	MP8007GV

**EVB TEST RESULTS**

$V_{IN}=48V$ ,  $V_{OUT}=12V$ ,  $I_{OUT}=1A$ ,  $T_A=25^{\circ}C$ , unless otherwise noted.

**Efficiency vs. Load Current**

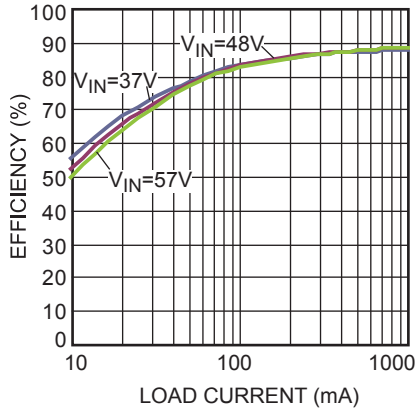

**Load Regulation**

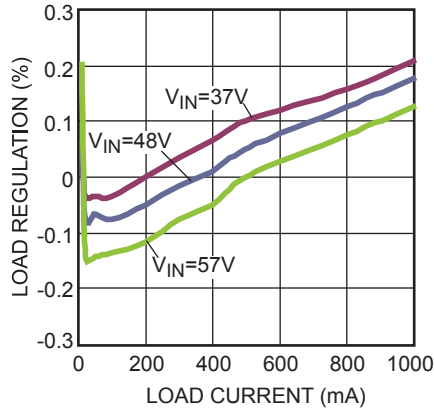

**Line Regulation**

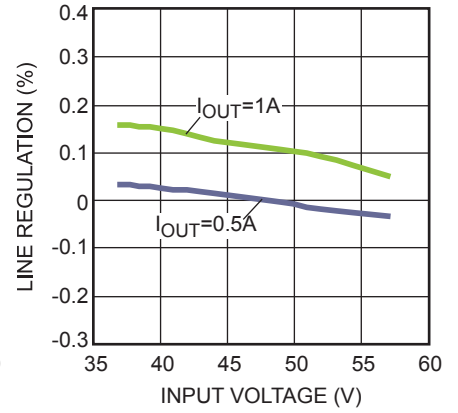

**Case Temperature Rise**

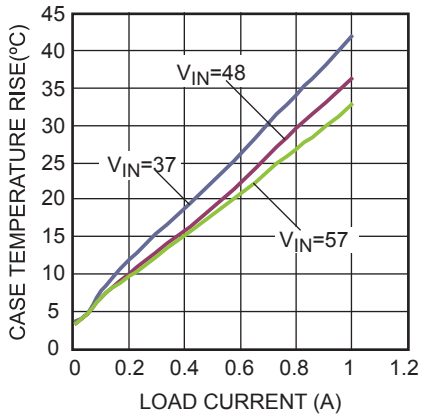

**EVB TEST RESULTS (continued)**

$V_{IN}=48V$ ,  $V_{OUT}=12V$ ,  $I_{OUT}=1A$ ,  $T_A=25^{\circ}C$ , unless otherwise noted.

**Steady State**  
 $I_{OUT} = 10mA$

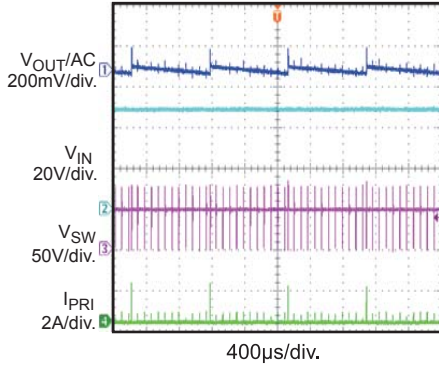

**Steady State**  
 $I_{OUT} = 100mA$

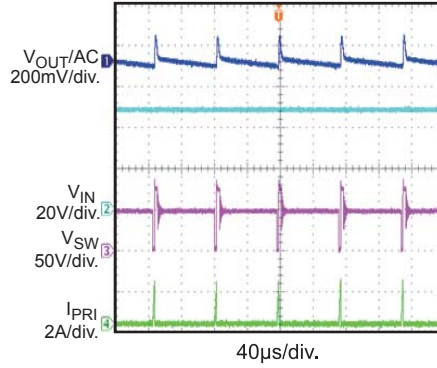

**Steady State**  
 $I_{OUT} = 1A$

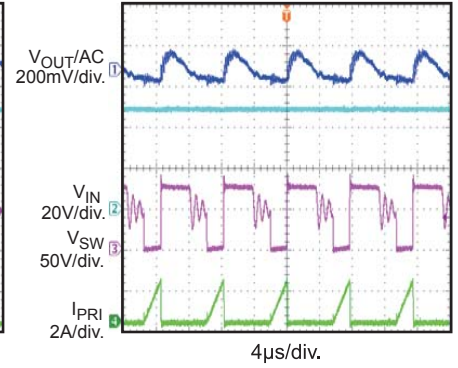

**VIN Start-Up**  
 $I_{OUT} = 10mA$

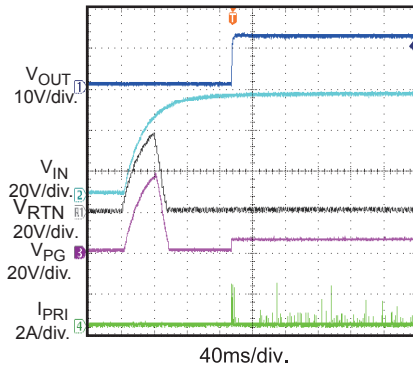

**VIN Start-Up**  
 $I_{OUT} = 1A$

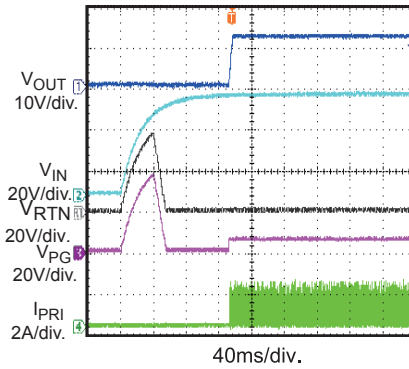

**VIN Shutdown**  
 $I_{OUT} = 10mA$

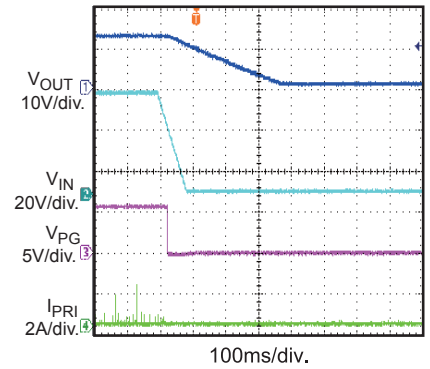

**VIN Shutdown**  
 $I_{OUT} = 1A$

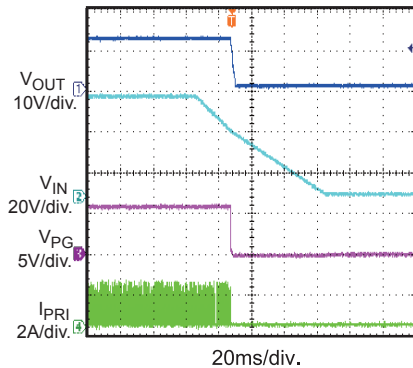

**SCP Entry**  
 $I_{OUT} = 10mA$

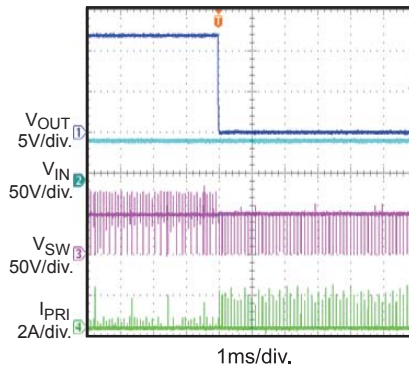

**SCP Entry**  
 $I_{OUT} = 1A$

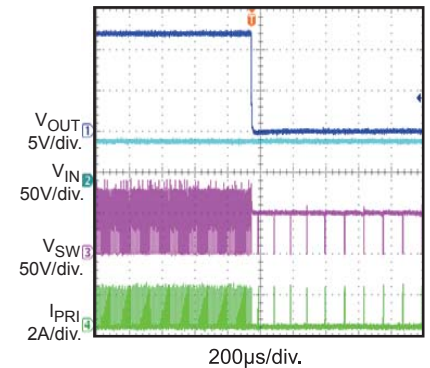

**EVB TEST RESULTS (continued)**

$V_{IN}=48V$ ,  $V_{OUT}=12V$ ,  $I_{OUT}=1A$ ,  $T_A=25^{\circ}C$ , unless otherwise noted.

**SCP Recovery**

$I_{OUT} = 10mA$

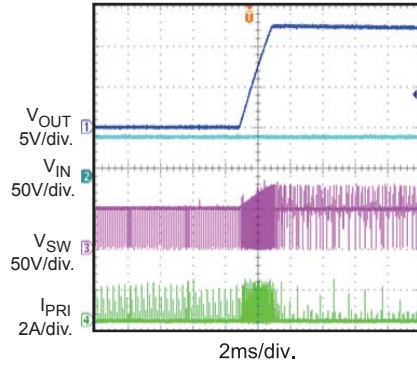

**SCP Recovery**

$I_{OUT} = 1A$

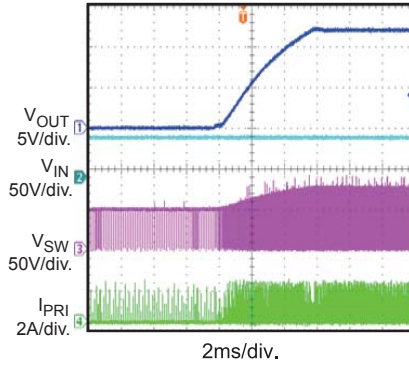

**Load Transient**

$I_{OUT} = 10mA$  to  $0.5A$ ,  
 $I_{RAMP} = 25mA/\mu s$

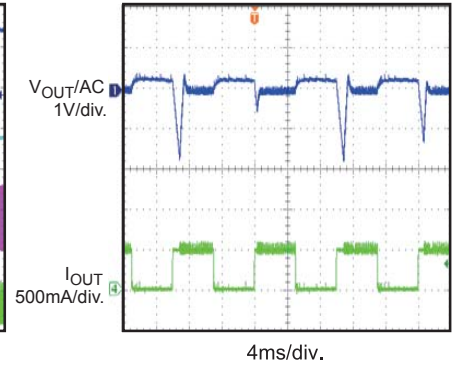

**Load Transient**

$I_{OUT} = 0.5A$  to  $1A$ ,  
 $I_{RAMP} = 25mA/\mu s$

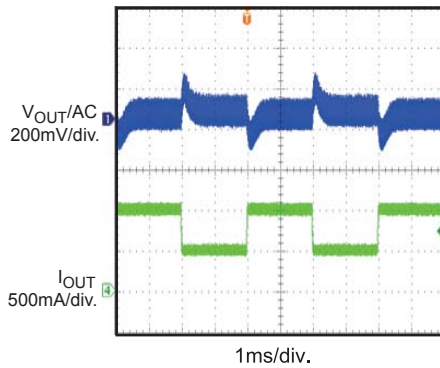

**OVP**

$I_{OUT} = 100mA$  to  $2mA$

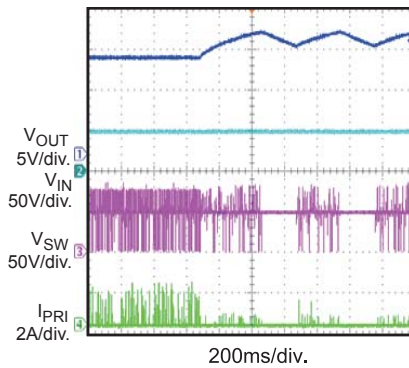

**FB1 Open-Circuit Entry**

$I_{OUT} = 1A$

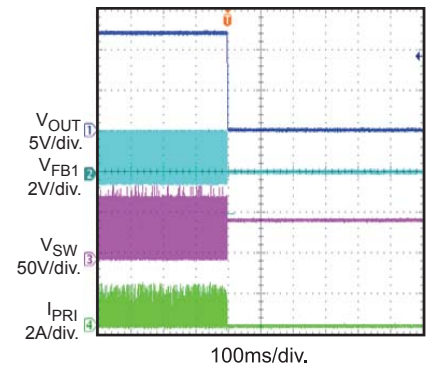

**FB1 Open-Circuit Recovery**

$I_{OUT} = 1A$

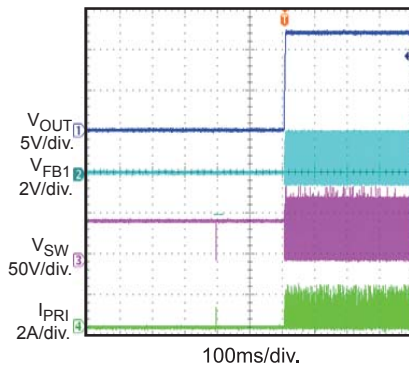

**PRINTED CIRCUIT BOARD LAYOUT**

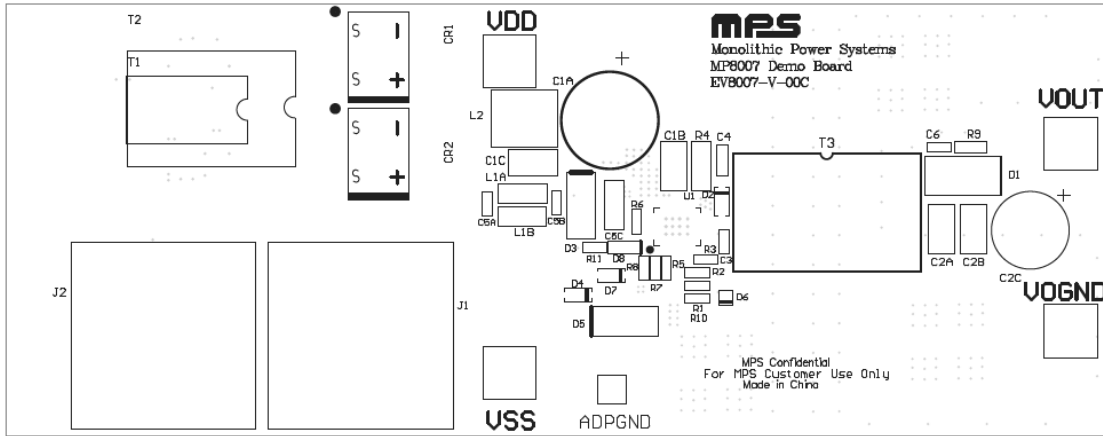

**Figure 1: Top Silk Layer**

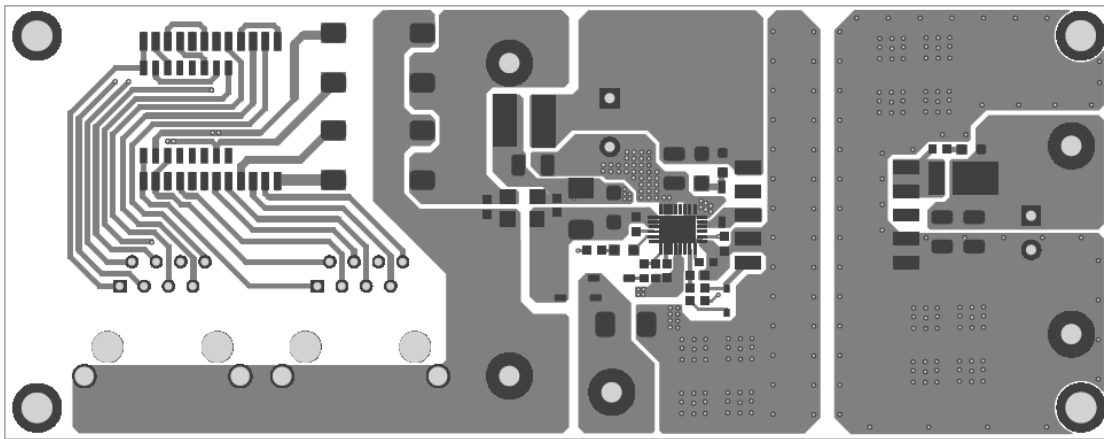

**Figure 2: Top Layer**

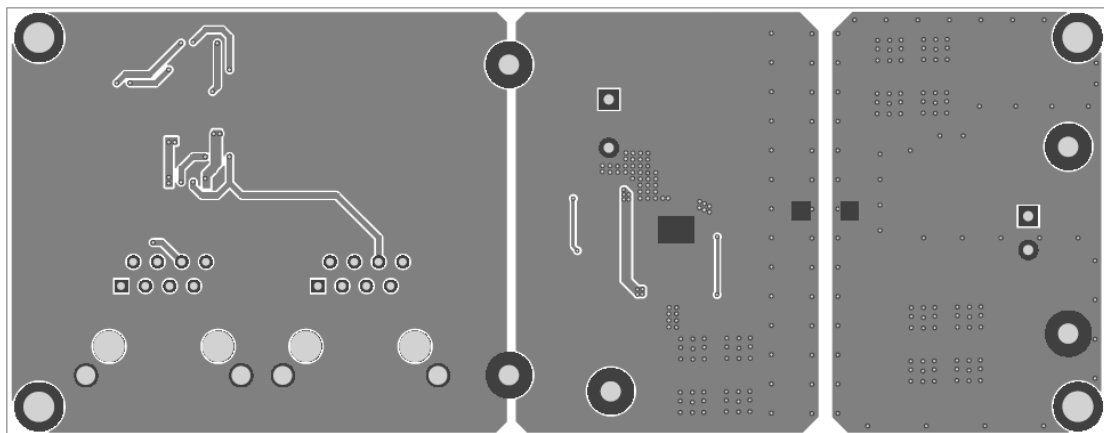

**Figure 3: Bottom Layer**



## QUICK START GUIDE

The output voltage of this board is set to 12V. The board layout accommodates most commonly used components. There are two methods to start MP8007.

Method 1:

1. Connect Load to:
  - a. Positive (+): VOUT
  - b. Negative (–): VOGND
2. Plug the cable coming from the PSE into the Ethernet Jack J1. The board will automatically startup.

Method 2:

1. Preset Power Supply to  $40V \leq V_{IN} \leq 57V$ . (It can work in  $37V \leq V_{IN} \leq 57V$  after power up.)
2. Turn Power Supply off.
3. Connect Power Supply terminals to:
  - a. Positive (+): VDD
  - b. Negative (–): VSS
4. Connect Load to:
  - a. Positive (+): VOUT
  - b. Negative (–): VOGND
5. Turn Power Supply on after making connections.
6. The MP8007 is enabled on the evaluation board once VDD is applied.
7. MP8007 can supply  $V_{CC}$  through internal high voltage LDO, D6 and R10 can be removed to save BOM cost, while it may lead to about 0.2% efficiency decreasing.
8. To use adapter supply function, connect the adapter's positive terminal to VDD and negative terminal to ADPGND, then turn on the adapter, the board will prior use adapter to supply itself.

**NOTICE:** The information in this document is subject to change without notice. Please contact MPS for current specifications. Users should warrant and guarantee that third party Intellectual Property rights are not infringed upon when integrating MPS products into any application. MPS will not assume any legal responsibility for any said applications.