

### DESCRIPTION

The EV8714-LE-00A is used for demonstrating the performance of MPS's MP8714. MP8714 is a highly integrated and high frequency synchronous step-down switch-mode converter. It is optimized to support up to 10A load current over an input supply range from 4.5V to 17V with excellent load and line regulation.

Current-Mode operation provides fast transient response and eases loop stabilization.

EN/SYNC supports external clock synchronization, and an open-drain power good pin(PG) indicates when the output voltage is in the nominal range.

Full protection features include over voltage, hiccup over-current protection and thermal shut down.

The MP8714 is available in QFN-14(3mmx4mm) package.

### ELECTRICAL SPECIFICATION

Parameter	Symbol	Value	Units
Input Voltage	V <sub>IN</sub>	4.5– 17	V
Output Voltage	V <sub>OUT</sub>	1	V
Output Current	I <sub>OUT</sub>	10	A

### FEATURES

- Wide 4.5V-to-17V Operating Input Range
- 10A continues Output Current
- 26mΩ High-side, 11mΩ Low-Side RDS(ON) for Internal Power MOSFETS
- 200kHz-2MHz Synchronized External Clock
- Programmable Soft-Start(SS) Time
- Open-Drain Power Good(PG) Indicator
- Output Over-Voltage Protection (OVP)
- Thermal Shutdown
- Available in a Small QFN-14(3mmx4mm) Package

### APPLICATIONS

- Flat-Panel Televisions and Monitors
- Set-Top Boxes
- Distributed Power Systems

All MPS parts are lead-free, halogen free, and adhere to the RoHS directive. For MPS green status, please visit MPS website under Quality Assurance. "MPS" and "The Future of Analog IC Technology" are Registered Trademarks of Monolithic Power Systems, Inc.

## EV8714-LE-00A EVALUATION BOARD

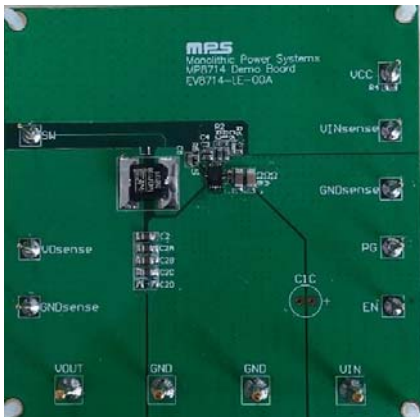

Board Number	MPS IC Number
EV8714-LE-00A	MP8714GLE

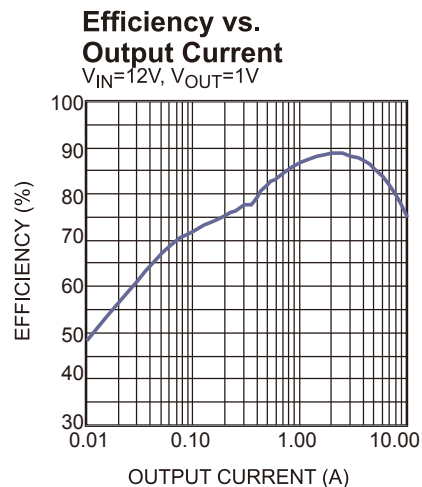

## EVALUATION BOARD SCHEMATIC

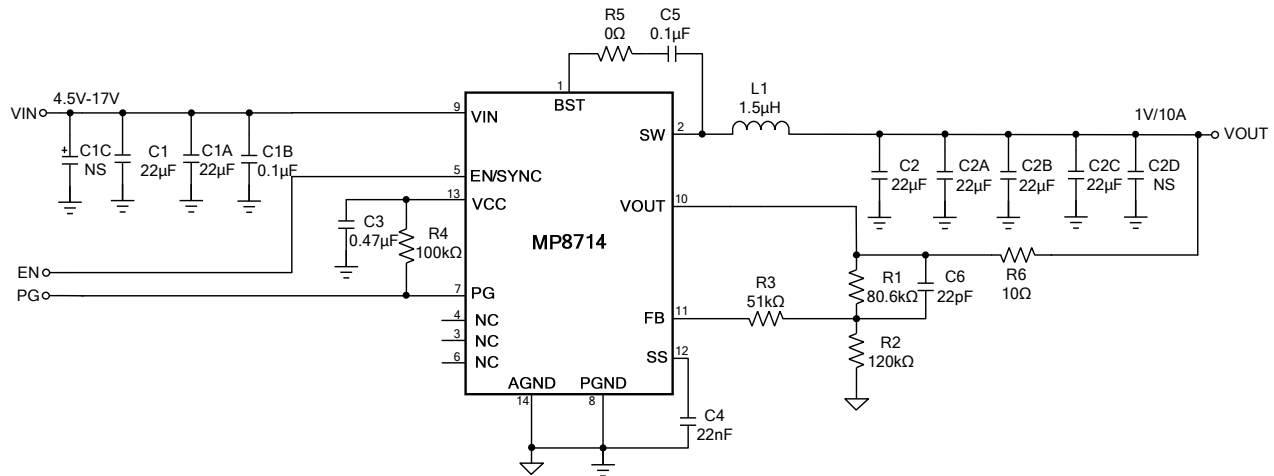

## EV8714-LE-00A BILL OF MATERIALS

Qty	RefDes	Value	Description	Package	Manufacturer	Manufacturer P/N
1	R1	80.6k	Film Res,1%	0603	ROYAL	RC0603FR-0780K6L
1	R2	120k	Film Res,1%	0603	ROYAL	RL0603FR-07120KL
1	R3	51k	Film Res,1%	0603	ROYAL	RL0603FR-0751KL
1	R4	100k	Film Res,1%	0603	ROYAL	RL0603FR-07100KL
1	R5	0Ω	Film Res,1%	0402	RALEC	RTT020000FTP
1	R6	10 Ω	Film Res,1%	0603	ROYAL	RL0603FR-0710RL
2	C1B, C5	0.1μF	Ceramic Cap,25V,X7R	0603	muRata	GRM188R71E104KA01D
2	C1A, C1	22μF	Ceramic Cap,25V,X5R	1206	muRata	GRM31CR61E226KE15L
4	C2, C2A, C2B, C2C	22μF	Ceramic Cap, 25V,X5R	0805	muRata	GRM21BR61E226ME44L
2	C2D, C1C	NS				
1	C3	0.47 μF	Ceramic Cap,16V,X7R	0603	muRata	GRM188R71C474KA88D
1	C4	22nF	Ceramic Cap,16V,X7R	0603	muRata	GRM188R71C223KA01D
1	C6	22pF	Ceramic Cap,50V,C0G	0603	muRata	GRM1885C1H220JA01D
1	L1	1.5μH	IR=11A,Isat=14A, DCR=6.6m Ω	SMD	Wurth	744 311 150
1	U1	MP8714	Step-Down Converter	QFN14 (3*4)	MPS	MP8714GLE

## EV8 TEST RESULTS

Performance waveforms are tested on the evaluation board.

$V_{IN} = 12V$ ,  $V_{OUT} = 1V$ ,  $L = 1.5\mu H$ ,  $T_A = 25^\circ C$ , unless otherwise noted.

**Short Entry**

$I_{OUT} = 0A$

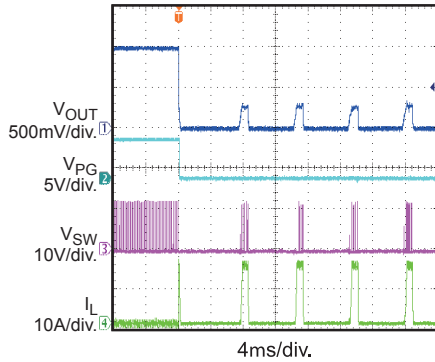

**Short Recovery**

$I_{OUT} = 0A$

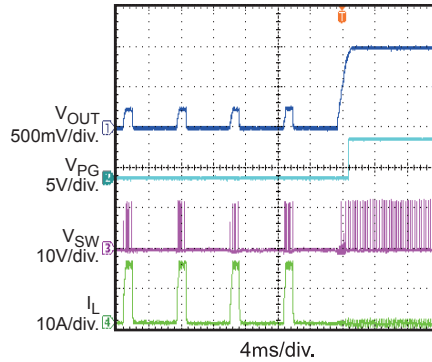

**Start-Up through Enable**

$I_{OUT} = 0A$

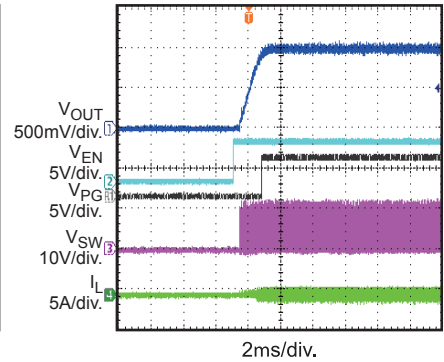

**Start-Up through Enable**

$I_{OUT} = 10A$

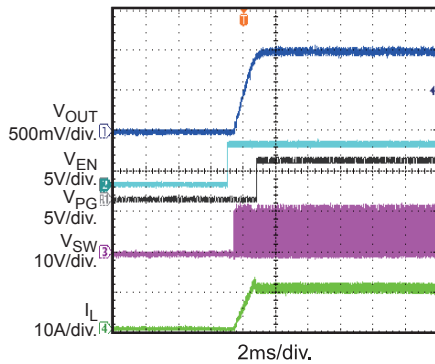

**Shutdown through Enable**

$I_{OUT} = 0A$

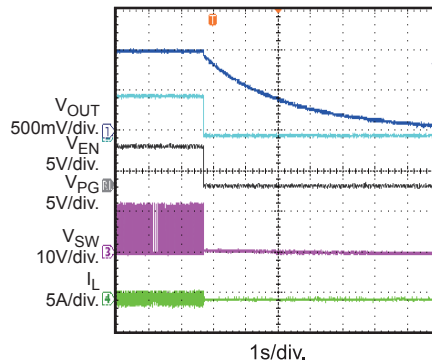

**Shutdown through Enable**

$I_{OUT} = 10A$

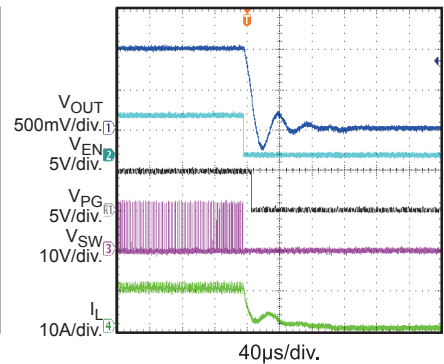

**Start-Up through Input Voltage**

$I_{OUT} = 0A$

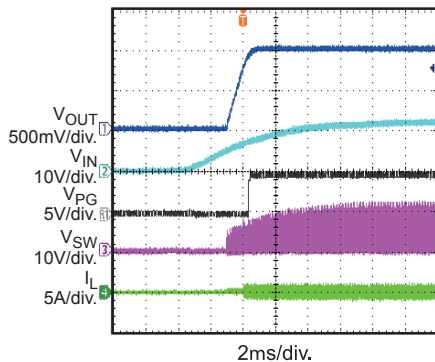

**Start-Up through Input Voltage**

$I_{OUT} = 10A$

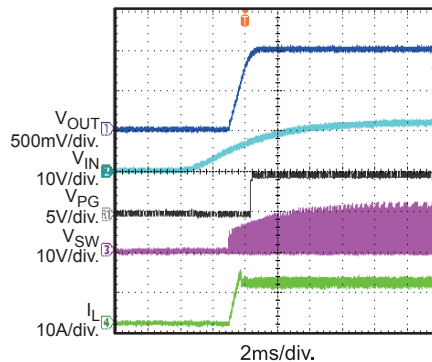

**Shutdown through Input Voltage**

$I_{OUT} = 0A$

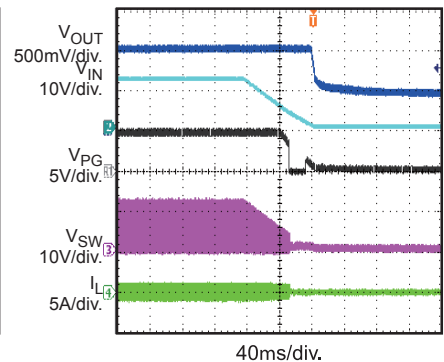

## EVB TEST RESULTS *(continued)*

Performance waveforms are tested on the evaluation board.

$V_{IN} = 12V$ ,  $V_{OUT} = 1V$ ,  $L = 1.5\mu H$ ,  $T_A = 25^\circ C$ , unless otherwise

### Shutdown through Input Voltage

$I_{OUT} = 10A$

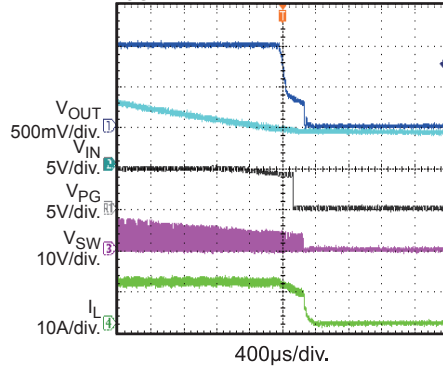

### Input/Output Ripple

$I_{OUT} = 10A$

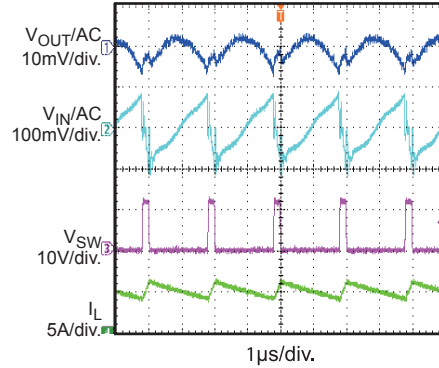

### Input/Output Ripple

$I_{OUT} = 0A$ , PFM

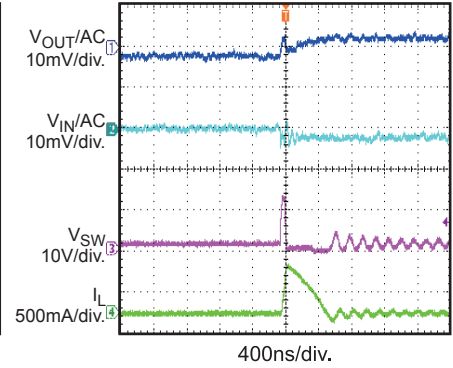

### Load Transient Response

$I_{OUT} = 5A$  to  $10A$

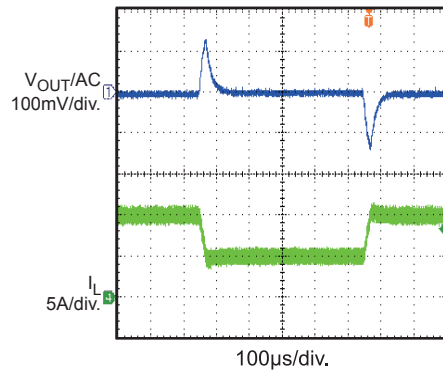

### PRINTED CIRCUIT BOARD LAYER

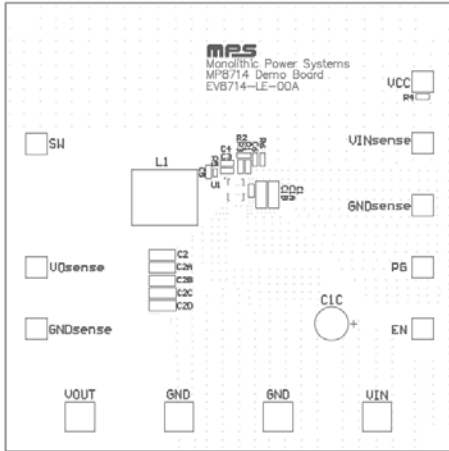

Figure 1: Top Silk Layer

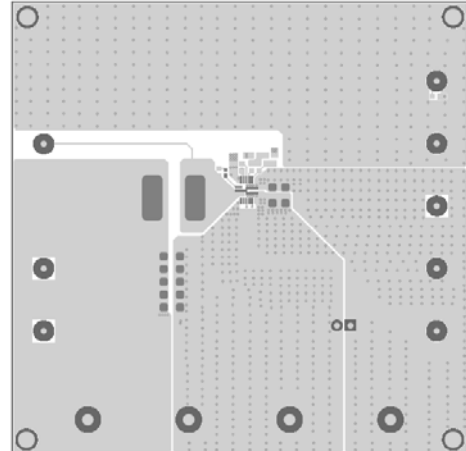

Figure 2: Top Layer

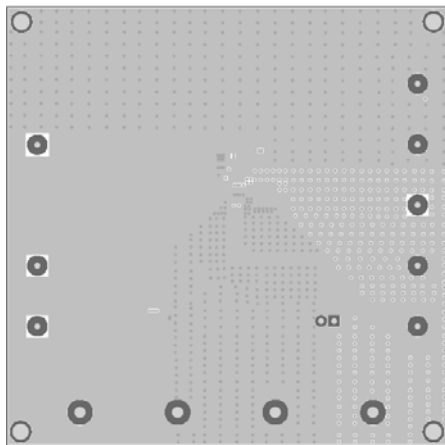

Figure 3: Inner 1 Layer

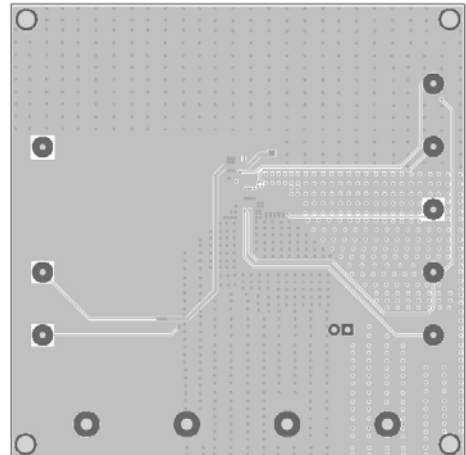

Figure 4: Inner 2 Layer

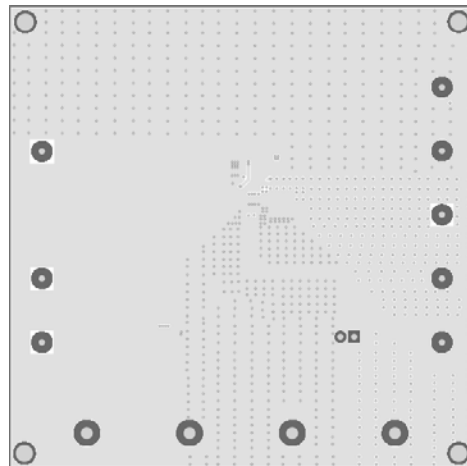

Figure 5: Bottom Layer

## QUICK START GUIDE

1. Connect the positive and negative terminals of the load to the VOUT and GND pins, respectively.
2. Preset the power supply output between 4.5V and 17V, and then turn off the power supply.
3. Connect the positive and negative terminals of the power supply output to the VIN and GND pins, respectively.
4. Turn the power supply on. The board will automatically start up.
5. To use the Enable function, apply a digital input to the EN pin. Drive EN higher than 1.5V to turn on the regulator, or less than 1.03V to turn it off.

**NOTICE:** The information in this document is subject to change without notice. Please contact MPS for current specifications. Users should warrant and guarantee that third party Intellectual Property rights are not infringed upon when integrating MPS products into any application. MPS will not assume any legal responsibility for any said applications.