

### DESCRIPTION

The EV8720-Q-00A is the evaluation board for MP8720. The MP8720 provides a complete power supply with the highest power density for system power like DDR memory and USB Type-C. It integrates a high-frequency, synchronous, rectified, step-down, switch-mode converter (VOUT) with adjustable CLM (Current limit).

The MP8720 operates at high efficiency over a wide output current load range based on MPS proprietary switching loss reduction technology and internal low Ron power MOSFETs.

Adaptive constant-on-time (COT) control mode provides fast transient response and eases loop stabilization. The DC auto-tune loop provides good load and line regulation.

By setting CLM Pin, the current limit can be adjusted from 8.5A to 16.5A for different mode application.

Full protection features include OC limit, OVP, UVP, and thermal shutdown.

The converter requires a minimum number of external components and is available in a QFN 3mm x 3mm package.

### FEATURES

- Wide 4.5 V to 26 V Operating Input Range
- Compatible for IMVP9 and USB Type-C
- 10 A Continuous Output Current
- Adjustable Current Limit from 8.5A to 16.5A
- Fixed 700KHz Switching Frequency
- Adaptive COT for Fast Transient
- DC Auto-Tune Loop
- Stable with POSCAP and Ceramic Output Capacitors
- Internal Soft Start
- Selectable Pulse Skip or Forced CCM
- Output Adjustable from 0.8V to 5.5V
- OCL, OVP, UVP, and Thermal Shutdown
- Latch-Off Reset via EN or Power Cycle
- QFN 3mm x 3mm Package

### APPLICATIONS

- Laptop Computer
- Motherboard
- Networking Systems and Server
- Distributed Power Systems

All MPS parts are lead-free, halogen free, and adhere to the RoHS directive. For MPS green status, please visit MPS website under Quality Assurance. "MPS" and "The Future of Analog IC Technology" are Registered Trademarks of Monolithic Power Systems, Inc.

## EV8720-Q-00A EVALUATION BOARD

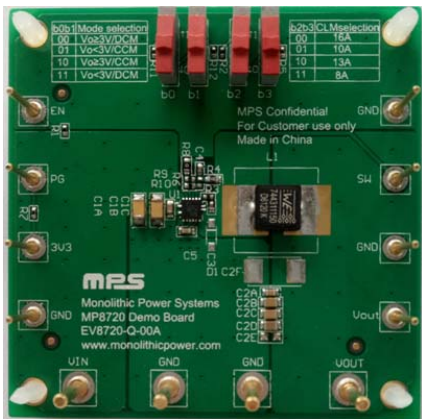

(L x W) 64mm x 64mm

Board Number	MPS IC Number
EV8720-Q-00A	MP8720GQ

### Efficiency vs. Output Current

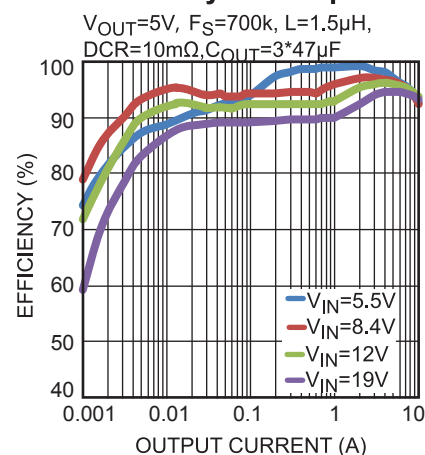

## EVALUATION BOARD SCHEMATIC

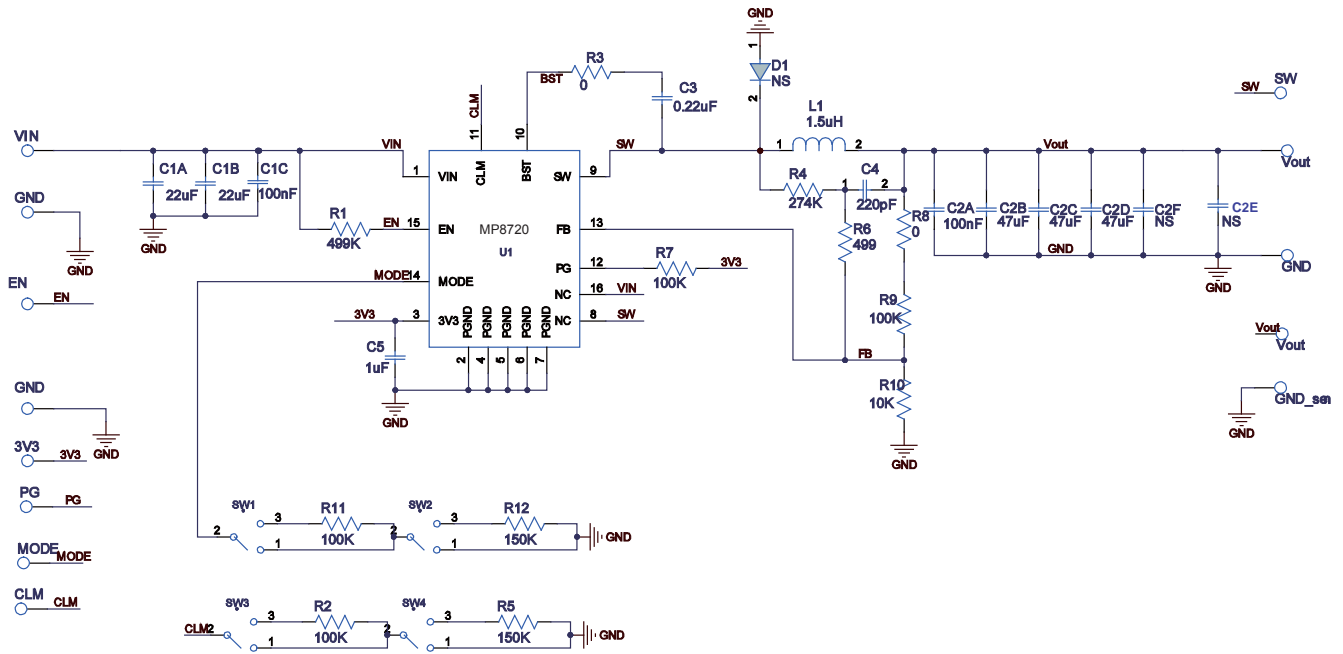

$V_{IN}=6-24V$ ,  $V_{OUT}=5V$ ,  $I_{OUT}=10A$ ,  $f_{SW}=700kHz$

**EV8720-Q-00A BILL OF MATERIALS**

Qty	Ref	Value	Description	Package	Manufacturer	Part Number
2	C1A, C1B	22 $\mu$ F	Ceramic Capacitor; 25V;X5R;1206;	1206	muRata	GRM31CR61E226KE15L
2	C1C,C2A	100nF	Ceramic Capacitor; 50V;X7R;0603;	0603	Wurth	885012206095
3	C2B,C2C, C2D,	47 $\mu$ F	Ceramic Capacitor; 10V;X5R	0805	muRata	GRM21BR61A476ME15L
0	C2E, C2F	NS				
1	C3	220nF	Capacitor;16V;X5R	0402	Wurth	885012105017
1	C4	220pF	Ceramic Capacitor; 50V;X7R;0402;	0402	Wurth	885012205057
1	C5	1 $\mu$ F	Ceramic Capacitor; 6.3V;X5R;0603	0603	muRata	GRM188R60J105KA01D
0	D1	NS				
1	L1	1.5uH	Inductor;1.5 $\mu$ H; 10m;14A	SMD	Wurth	744311150
1	R1	499k	Film Resistor;1%;	0402	Yageo	RC0402FR-0499KL
1	R3	0	Film Resistor;5%;	0402	Yageo	RC0402JR-070RL
1	R4	274k	Film Resistor;1%;	0603	Yageo	RC0603FR-07274KL
1	R6	499	Film Resistor;1%;	0402	Yageo	RC0402FR-07499RL
4	R2,R7,R9,R 11	100K	Film Resistor;1%;	0402	Yageo	RC0402FR-07100KL
1	R10	10k	Film Resistor;1%;	0402	Yageo	RC0402FR-0710KL
1	R8	0	Film Resistor;1%;	0603	Yageo	RC0603FR-070RL
2	R12,R5	150k	Film Resistor;1%;	0402	Yageo	RC0402FR-07150KL
1	U1		Step down converter	QFN 3 $\times$ 3	MPS	MP8720GQ
4	b0,b1,b2,b3		Button	DIP	Wurth	450301014042

# PRINTED CIRCUIT BOARD LAYOUT

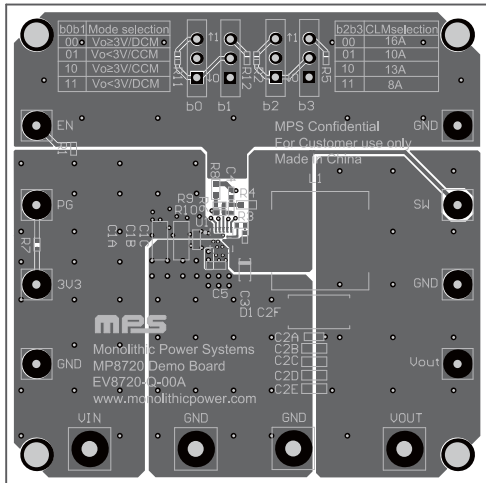

**Figure 1—Top Layer**

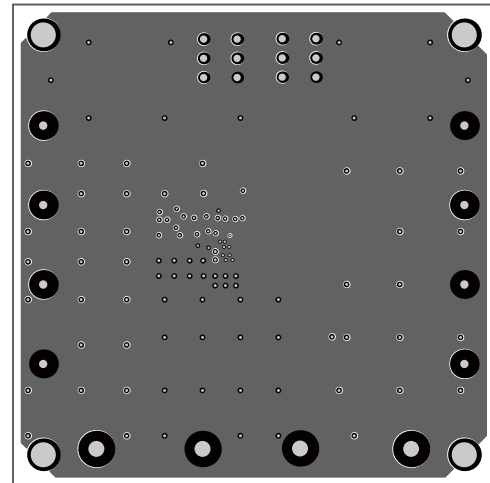

**Figure 2—Inner Layer 1**

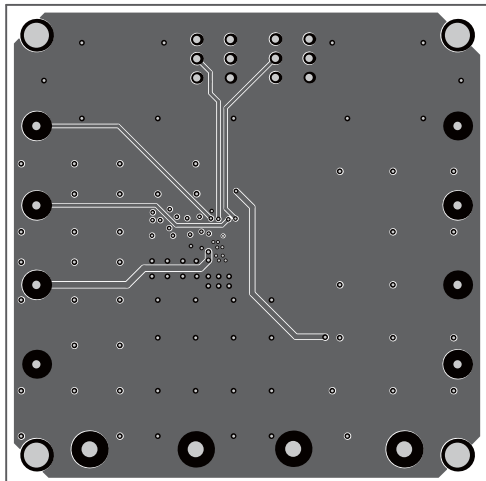

**Figure 3—Inner Layer 2**

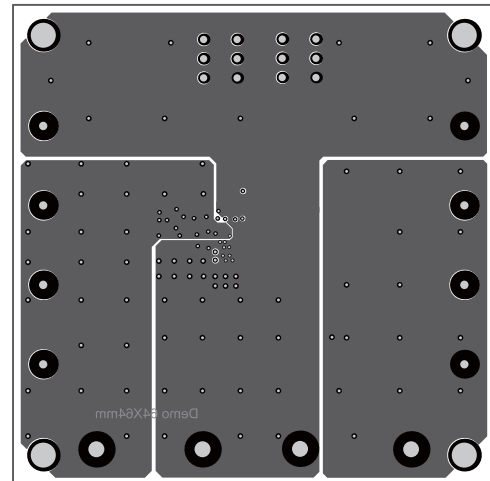

**Figure 4— Bottom Layer**

## QUICK START GUIDE

1. Connect the positive and negative terminals of the load to the VOUT and GND pins, respectively.
2. Preset the one power supply output between 4.5V and 24V as VIN, and another power supply to 3.3V as external 3.3V VCC, and then turn off the power supply.
3. Connect the positive and negative terminals of the VIN power supply output to the VIN and GND pins, respectively.
4. Connect the positive and negative terminals of the power 3.3V supply output to the 3V3 and GND Pins, respectively.
5. Turn both the VIN and 3V3 power supply on. The MP8720 will automatically startup.
6. To use the Enable function, apply a digital input to the EN pin. Drive EN to 3.3V to turn on the regulator or less than 0.4V to turn it off.

## MODE SELECTION AND CLM SELECTION

MP8720 implements MODE for multiple applications for Output and switching mode selection. The output and the switch mode can be selected by a different resistor on the Mode pin. There are four modes that can be selected for normal application with external resistors. It is recommended to use a 1% accuracy resistor, see Table 1.

**Table 1—Mode Selection**

State	VOUT	DCM/CCM	Resistor to GND
M1	$V_o < 3V$	DCM	0
M2	$V_o < 3V$	CCM	90 K
M3	$V_o \geq 3V$	CCM	150 K
M4	$V_o \geq 3V$	DCM	>230 K or float

MP8720 implements adjustable valley CLM by connected CLM to GND with different values of resistor. See table 2 for different CLM selection.

**Table 2—CLM Selection**

State	CLM	Resistor to GND
M1	8.5A	0
M2	10A	90 K
M3	13A	150 K
M4	16.5A	>230 K or float

**NOTICE:** The information in this document is subject to change without notice. Users should warrant and guarantee that third party Intellectual Property rights are not infringed upon when integrating MPS products into any application. MPS will not assume any legal responsibility for any said applications.