

DESCRIPTION

The EV8726EL-00A is an evaluation board for the MP8726, a high frequency synchronous rectified step-down switch mode converter with built in internal power MOSFETs. It offers a very compact solution to achieve 6A continuous output current over a wide input supply range with excellent load and line regulation. The MP8726 operates at high efficiency over a wide output current load range.

Current mode operation provides fast transient response and eases loop stabilization.

Full protection features include OCP and thermal shut down.

The MP8726 requires a minimum number of readily available standard external components and is available in a space saving 3mm x 4mm 14-pin QFN package.

FEATURES

- Wide 8V to 21V Operating Input Range
- 6A Output Current
- Fixed 500kHz Switching Frequency
- Sync from 300kHz to 2MHz External Clock
- OCP Protection and Thermal Shutdown

APPLICATIONS

- Notebook Systems and I/O Power
- Networking Systems
- Digital Set Top Boxes
- Personal Video Recorders
- Flat Panel Television and Monitor
- Distributed Power Systems

"MPS" and "The Future of Analog IC Technology" are Registered Trademarks of Monolithic Power Systems, Inc.

ELECTRICAL SPECIFICATIONS

Parameter	Symbol	Value	Units
Input Voltage	V _{IN}	8 – 21	V
Output Voltage	V _{OUT}	1.2	V
Output Current	I _{OUT}	6	A

EV8726EL-00A EVALUATION BOARD



Board Number	MPS IC Number
EV8726EL-00A	MP8726EL

Efficiency vs Vout

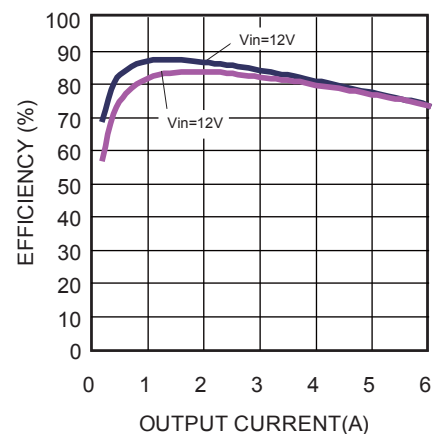

EVALUATION BOARD SCHEMATIC

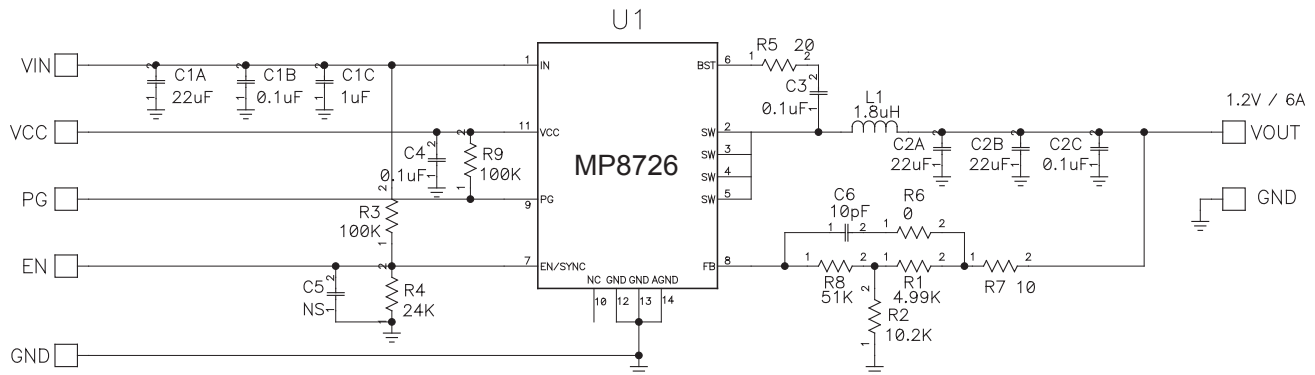

EV8708EN-00A BILL OF MATERIALS

Qty	Ref	Value	Description	Package	Manufacturer	Part Number
1	C1A	22uF	Ceramic Cap., 25V, X5R	1210	Murata	GRM32ER61E226KE15L
1	C1B	0.1uF	Ceramic Cap., 25V, X7R	0805	Any	
1	C1C	1uF	Ceramic Cap., 25V, X7R	0805	Any	
2	C2A,C2B	22uF	Ceramic Cap., 6.3V, X5R	1210	Murata	GRM32DR60J226KA01L
1	C2C	0.1uF	Ceramic Cap., 16V, X7R	0805	Any	
2	C3,C4	0.1uF	Ceramic Cap., 25V, X7R	0603	Yageo	CC0603KRX7R8BB104
0	C5	NS		0603		
1	C6	10pF	Ceramic Cap., 50V,C0G	0603	TDK	C1608C0G1H100D
1	R1	4.99K	Film Res., 1%	0603	Yageo	RC0603FR-074K99L
1	R2	10.2K	Film Res., 1%	0603	Yageo	RC0603FR-0710K2L
2	R3,R9	100KΩ	Film Res., 5%	0603	Any	
1	R4	24kΩ	Film Res., 5%	0603	Any	
1	R5	20Ω	Film Res., 5%	0603	Any	
1	R6	0Ω	Film Res., 5%	0603	Any	
1	R7	10Ω	Film Res., 5%	0603	Any	
1	R8	51KΩ	Film Res., 5%	0603	Any	
1	L1	1.8uH	7.6mΩ, 10.4A	SMD	TOKO	D104C-919AS-1R8N
		2.2uH	14mΩ, 13A	SMD	Würth	744311220
1	U1		Step-Down Converter	QFN14	MPS	MP8726EL

PRINTED CIRCUIT BOARD LAYOUT

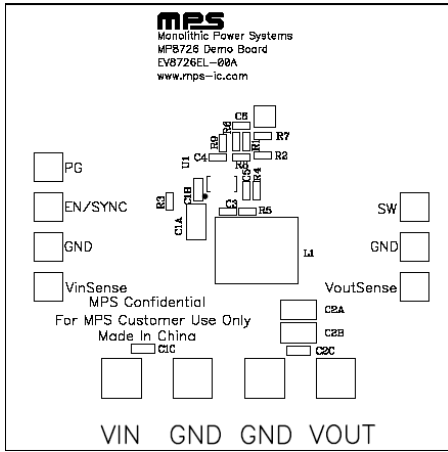

Figure 1—Top Silk Layer

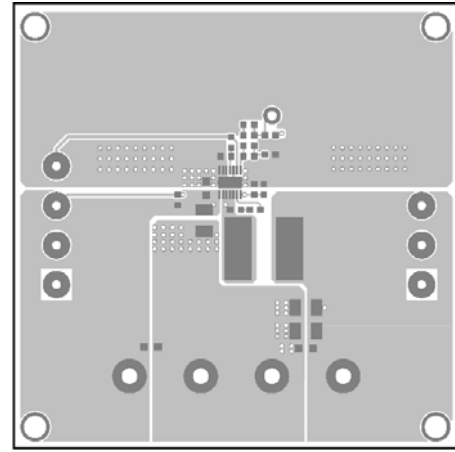

Figure 2—Top Layer

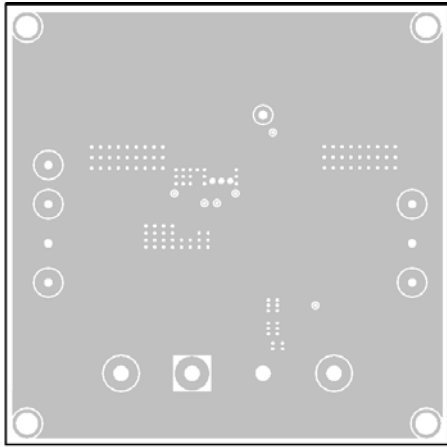

Figure 3—Inner Layer 1

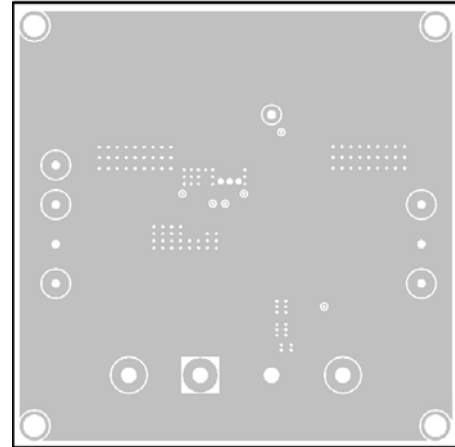

Figure 4—Inner Layer 2

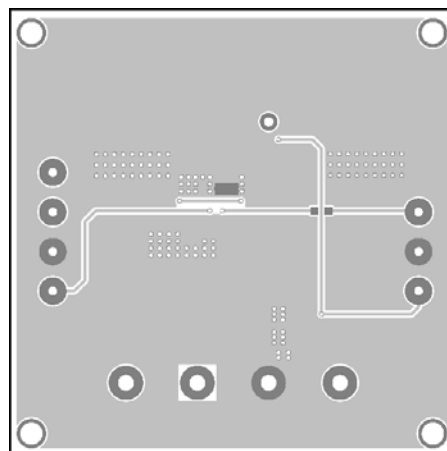

Figure 5—Bottom Layer

QUICK START GUIDE

1. Connect the positive and negative terminals of the load to the VOUT and GND pins, respectively.
2. Preset the power supply output between 8V and 21V, then turn off the power supply.
3. Connect the positive and negative terminals of the power supply output to the VIN and GND pins, respectively.
4. Turn the power supply on, the board will automatically startup.
5. To use the Enable function, apply a digital input to the EN pin. Drive EN higher than 2V to turn on the regulator or less than 0.4V to turn it off.
6. Apply up to 2MHz frequency logic level clock signal to the EN pin to synchronize the device to an external clock. The duty cycle is not critical.

NOTICE: The information in this document is subject to change without notice. Users should warrant and guarantee that third party Intellectual Property rights are not infringed upon when integrating MPS products into any application. MPS will not assume any legal responsibility for any said applications.