

DESCRIPTION

The EV8758-L-00A is used for demonstrating the performance of MP8758, a fully-integrated, high efficiency, synchronous step-down switch mode converter. MP8758 provides up to 10A continuous output current over a wide input supply range with constant-on-time control for fast loop response.

The Evaluation Board can deliver 10A continuous load current from a 7V to 18V input with excellent load and line regulation.

This part requires minimum number of external components and is available in QFN21 (3mmx4mm) package

ELECTRICAL SPECIFICATION

Parameter	Symbol	Value	Units
Input Voltage	V _{IN}	7-18	V
Output Voltage	V _{OUT}	5	V
Output Current	I _{OUT}	10	A
Switching Frequency	f _{sw}	500	kHz

FEATURES

- Wide 7V to 18V Operating Input Range
- 10A Continuous Output Current
- Low R_{DS(ON)} Internal Power MOSFETs
- Proprietary Switching Loss Reduction Technique
- Internal Soft Start
- Output Discharge
- 500kHz Switching Frequency
- OCP, UVP, OVP Protection and Thermal Shutdown
- Output Adjustable from 0.604V

APPLICATIONS

- Laptop Computer
- Tablet PC
- Networking Systems
- Personal Video Recorders
- Flat Panel Television and Monitors
- Distributed Power Systems

All MPS parts are lead-free and adhere to the RoHS directive. For MPS green status, please visit MPS website under Products, Quality Assurance page.

"MPS" and "The Future of Analog IC Technology", are Registered Trademarks of Monolithic Power Systems, Inc.

EV8758-L-00A EVALUATION BOARD



(L x W x H) 8.55cm x 8.55cm x 1.6cm

Board Number	MPS IC Number
EV8758-L-00A	MP8758GL

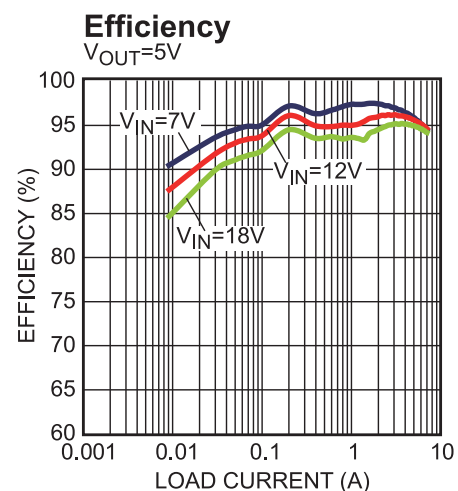

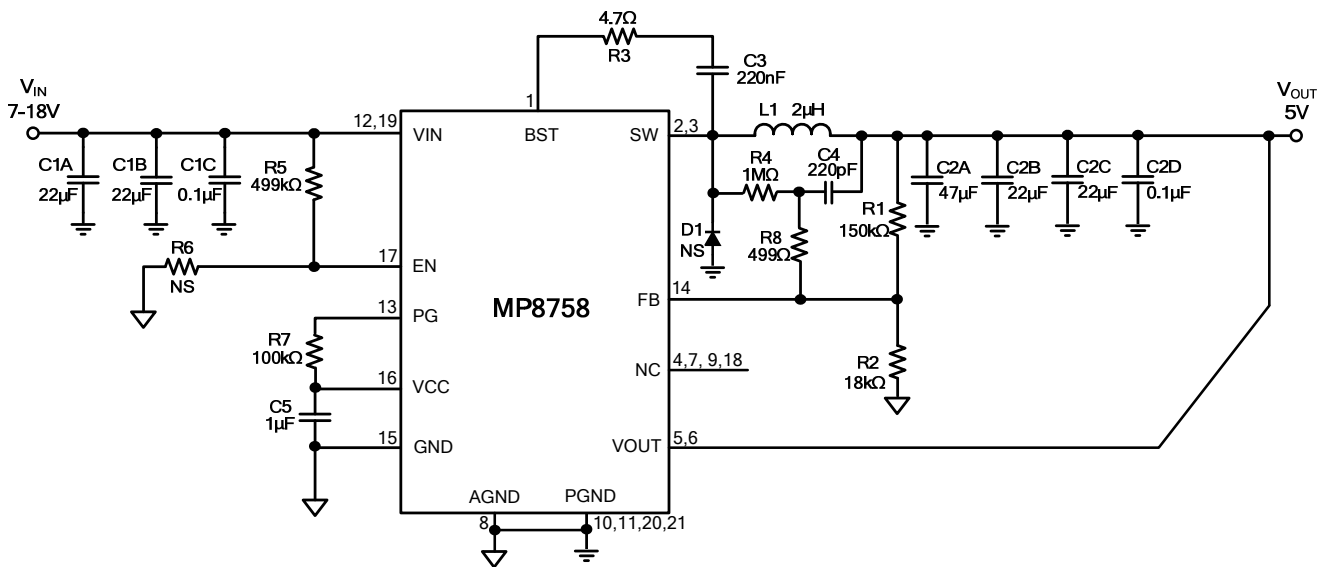
EVALUATION BOARD SCHEMATIC

EV8758-L-00A BILL OF MATERIALS

Qty	Ref	Value	Description	Package	Manufacturer	Manufacturer P/N
2	C1A,C1B	22 μ F	Ceramic Cap, 25V, X7R	1206	Murata	GRM31ER71E226KE15L
2	C1C,C2D	0.1 μ F	Ceramic Cap, 25V, X7R	0603	Murata	GRM188R71E104KA01D
1	C2A	47 μ F	Ceramic Cap, 6.3V, X5R	1206	Murata	GRM31CR60J476ME19L
2	C2B,C2C	22 μ F	Ceramic Cap, 16V, X5R	1206	Murata	GRM31CR61C226ME15L
1	C3	220nF	Ceramic Cap, 25V, X7R	0603	Murata	GRM188R71E224KA88D
1	C4	220pF	Ceramic Cap, 50V, X7R	0603	Murata	GRM188R71H221KA01D
1	C5	1 μ F	Ceramic Cap, 25V, X7R	0603	Murata	GRM188R71E105KA12D
1	L1	2 μ H	DCR=7.3m Ω , Isat=13A	SMD	Wurth	7443552200
1	R1	150k Ω	Film Res, 1%	0603	ROYAL	RL0603FR-07150KL
1	R2	18k Ω	Film Res, 1%	0603	ROYAL	RL0603FR-0718KL
1	R7	100k Ω	Film Res, 1%	0603	ROYAL	RL0603FR-07100KL
1	R3	4.7 Ω	Film Res, 1%	0603	ROYAL	RL0603FR-074R7L
1	R4	1M Ω	Film Res, 1%	0603	ROYAL	RL0603FR-071ML
0	R6	NS				
1	R5	499k Ω	Film Res, 1%	0603	ROYAL	RL0603FR-07499KL
1	R8	499 Ω	Film Res, 1%	SM0603	ROYAL	RL0603FR-07499RL
1	U1	MP8758GL	DC-DC Converter	QFN3 \times 4	MPS	MP8758GL

EV8 TEST RESULTS

Performance waveforms are tested on the EV8758-L-00A.

$V_{IN} = 12V$, $V_{OUT} = 5V$, $L = 2\mu H$, $T_J = +25^\circ C$, unless otherwise noted.

Output Voltage Ripple

$V_{IN} = 12V$, $V_{OUT} = 5V$, $I_{OUT} = 0.01A$

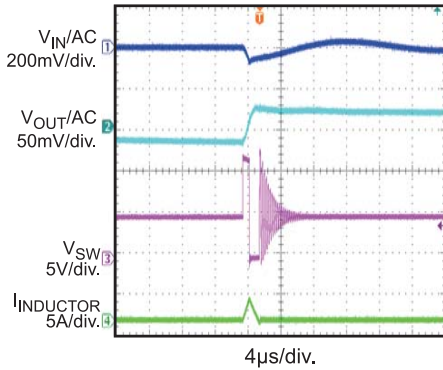

Output Voltage Ripple

$V_{IN} = 12V$, $V_{OUT} = 5V$, $I_{OUT} = 7A$

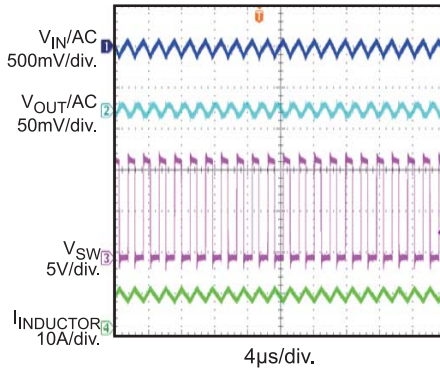

Start Up through VIN

$V_{IN} = 12V$, $V_{OUT} = 5V$, $I_{OUT} = 0.01A$

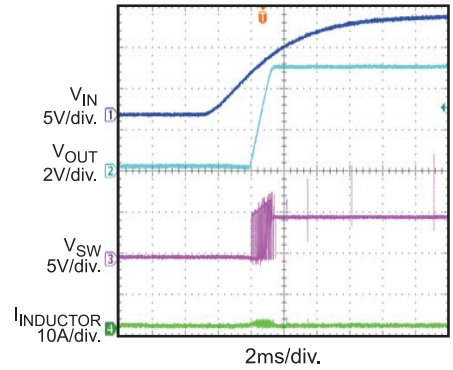

Start Up through VIN

$V_{IN} = 12V$, $V_{OUT} = 5V$, $I_{OUT} = 7A$

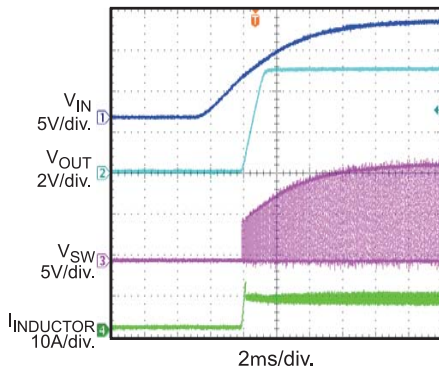

Shutdown through VIN

$V_{IN} = 12V$, $V_{OUT} = 5V$, $I_{OUT} = 0.01A$

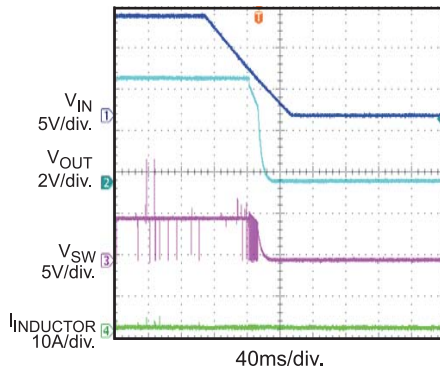

Shutdown through VIN

$V_{IN} = 12V$, $V_{OUT} = 5V$, $I_{OUT} = 7A$

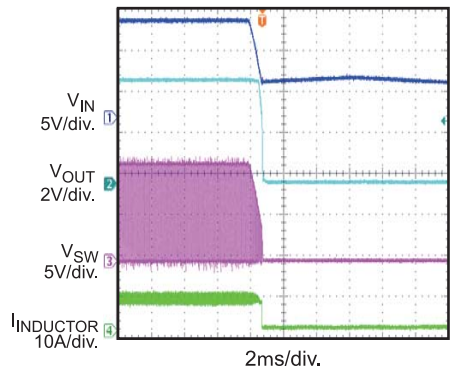

Start Up through EN

$V_{IN} = 12V$, $V_{OUT} = 5V$, $I_{OUT} = 0.01A$

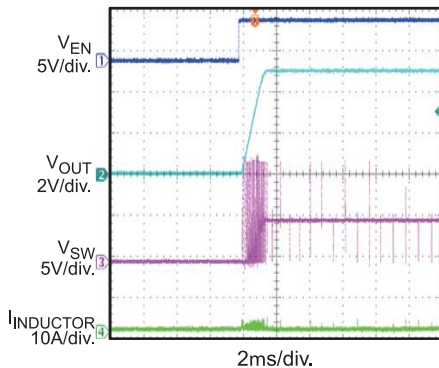

Start Up through EN

$V_{IN} = 12V$, $V_{OUT} = 5V$, $I_{OUT} = 7A$

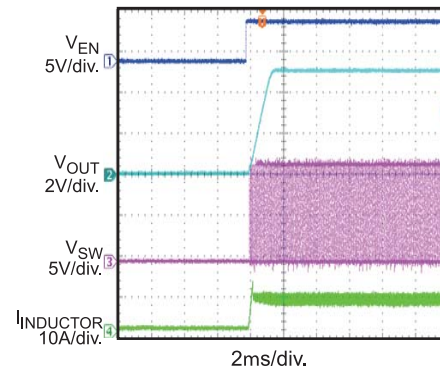

Shutdown through EN

$V_{IN} = 12V$, $V_{OUT} = 5V$, $I_{OUT} = 0.01A$

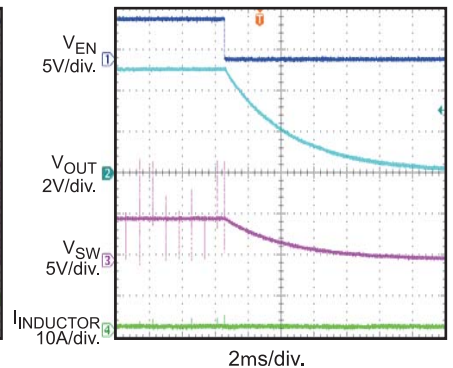

EVB TEST RESULTS (continued)

Performance waveforms are tested on the EV8758-L-00A.

$V_{IN} = 12V$, $V_{OUT} = 5V$, $L = 2\mu H$, $T_J = +25^\circ C$, unless otherwise noted.

Shutdown through EN

$V_{IN} = 12V$, $V_{OUT} = 5V$, $I_{OUT} = 7A$

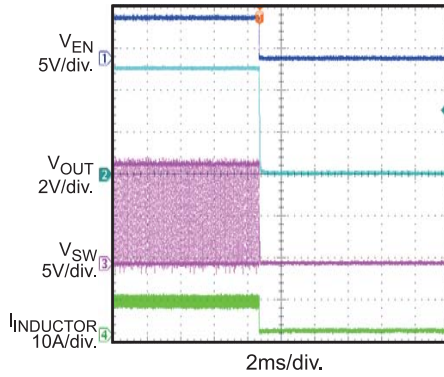

Transient Response

$V_{IN} = 12V$, $V_{OUT} = 5V$, $I_{OUT} = 3.5A-7.0A$,
 $SR = 1A/\mu s$

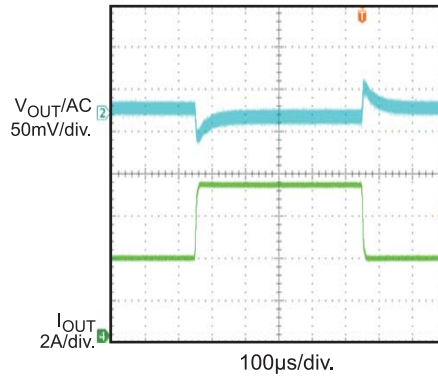

PRINTED CIRCUIT BOARD LAYOUT

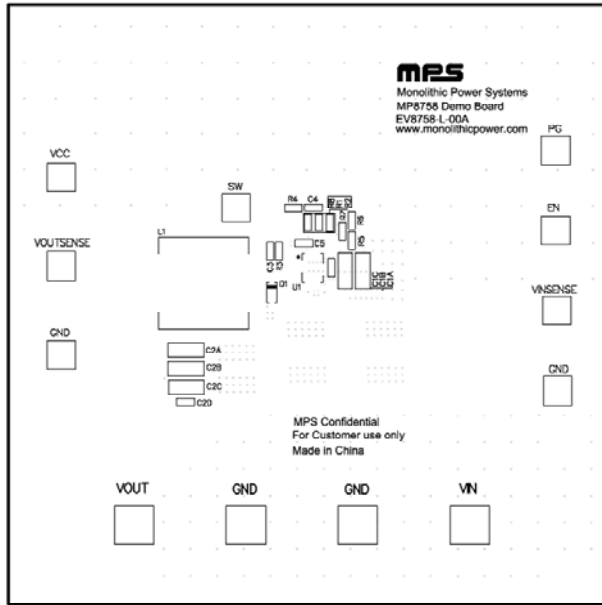

Figure 1: Top Silk Layer

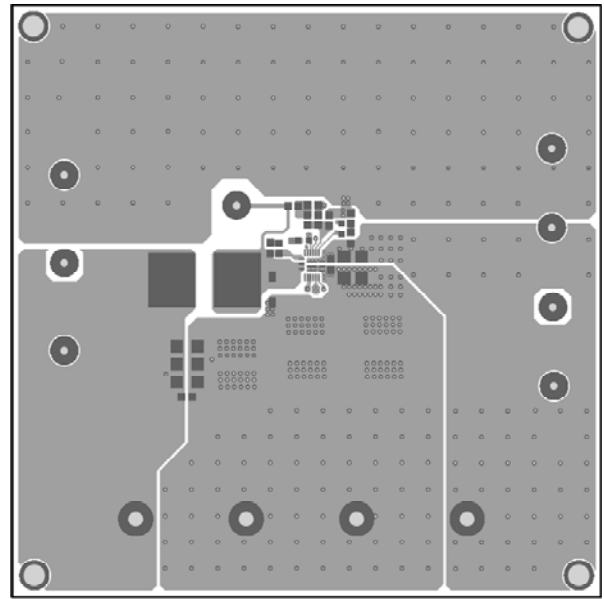

Figure 2: Top Layer

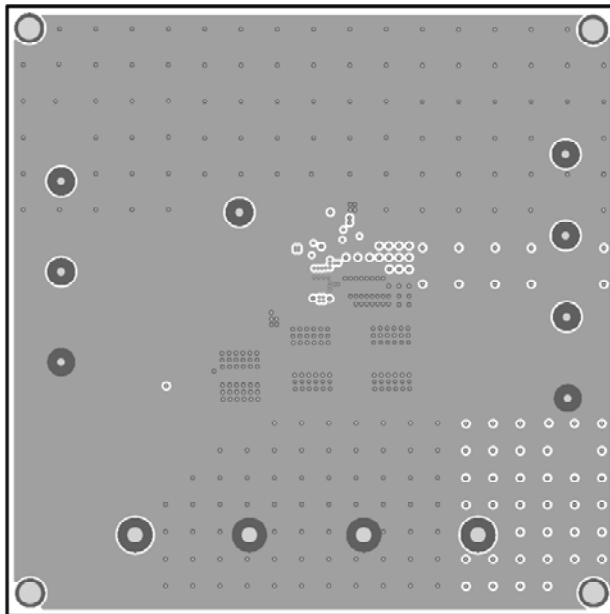

Figure 3: Inner Layer1

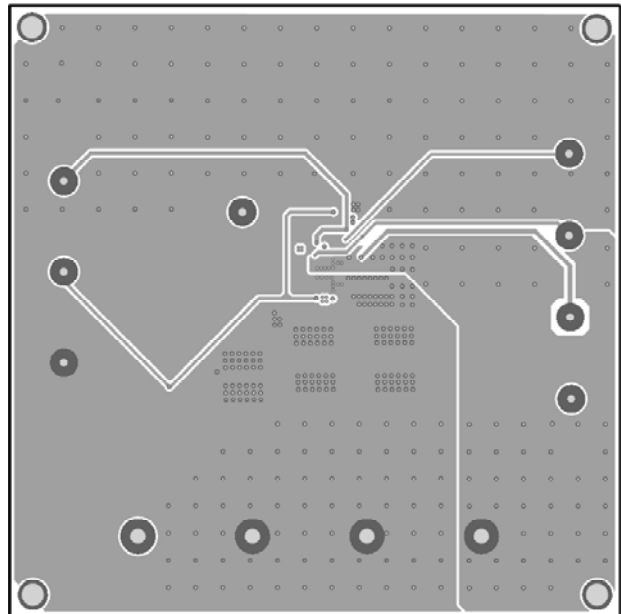

Figure 4: Inner Layer2

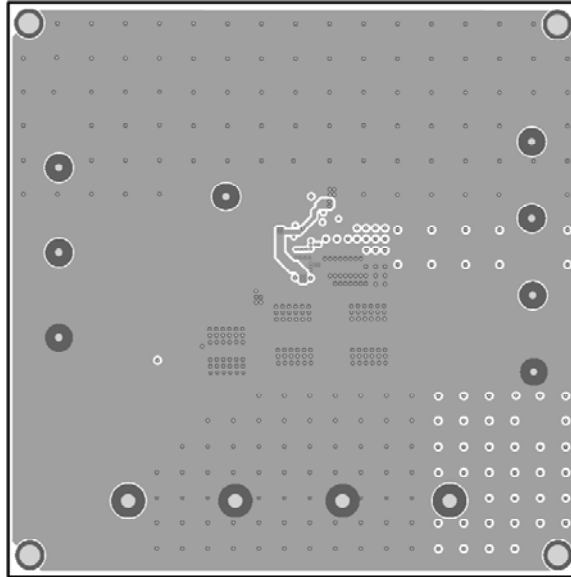

Figure 5: Bottom Layer

QUICK START GUIDE

1. Connect the positive and negative terminals of the load to the VOUT and GND pins respectively.
2. Preset the output of power supply between 7V and 18V, and then turn off the power supply.
3. Connect the positive and negative terminals of the power supply output to the VIN and GND pins respectively:
4. Turn the power supply on. The MP8758GL will automatically start up.
5. To use the Enable function, apply a digital input to the EN pin. Drive EN high to turn on the regulator or low to turn it off
6. Use R1 and R2 to set the output voltage. Follow the Application information section in the device datasheet to select the proper value of R1, R2, inductor and output capacitor values when output voltage is changed.

NOTICE: The information in this document is subject to change without notice. Please contact MPS for current specifications. Users should warrant and guarantee that third party Intellectual Property rights are not infringed upon when integrating MPS products into any application. MPS will not assume any legal responsibility for any said applications.